

**SPECIAL SECTION:
LASERS**

Radio — TV SCRAMBLING AND
DESCRAMBLING TECHNIQUES

\$1.95 JUNE 1986
IN CANADA \$2.50

Electronics

TECHNOLOGY - VIDEO - STEREO - COMPUTERS - SERVICE

BUILD YOUR OWN LASER

A portable helium-neon laser!

A
GERNSBACK
PUBLICATION

TV DESCRAMBLING

Here's how it works.

BUILD A HI-PERFORMANCE STEREO AMPLIFIER

100 watts per channel of
FET power.

BUILD A VARIABLE-VOLTAGE POWER SUPPLY

It features current limiting, too!

NEW LIFE FOR OLD LP's

Build R-E's scratch eliminator.

VOLTAGE COMPARATORS

Put them to work for you.

PLUS:

- ★ Ask R-E ★ Robotics ★ New Ideas
- ★ PC Service ★ Designer's Notebook
- ★ Antique Radios ★ **COMPUTER DIGEST**



Now! Tek quality and expert advice are just a free phone call away!

The industry standard in CRT performance. Crisp, easy-to-read, bright CRT; 14kV accelerating potential, provides high writing rate and small spot size. Full size 8x10 cm display for measurement accuracy.

Display controls are flexible and easy to use. Separate intensity controls reduce blooming in alternate sweep mode. Focus tracking minimizes control adjustment and BEAM FIND eliminates confusion.

Vertical system provides measurement assurance. Flat transient response and high accuracy ensures true reproduction of your signals. Fast risetime and high bandwidth is well suited for a variety of measurement.

Perform delayed sweep measurements accurately and easily. Both sweeps can be displayed alternately making differential measurements easy and accurate (1%). An interlocking SEC/DIV control simplifies set-up.

Stable hands-off triggering. P-P AUTO detects signal peaks, then sets the trigger level for you. Display asynchronous signals using VERT MODE triggering. Independent TV field and line selection.

Front panel laid out by function for ease of use. Color coding aids the user in operation. Functions and modes are placed logically. All nomenclature is clearly labeled, and protected behind a scratchless Lexan surface.



1-800-426-2200

Our direct order line gets you the industry's leading price performance portables... and fast answers from experts! The 60 MHz single time base delay 2213A, the 60 MHz dual time base 2215A and the 100 MHz dual time base 2235 offer unprecedented reliability and affordability, plus the industry's first 3-year warranty* on labor and parts, CRT included.

The cost: just \$1275 for the 2213A, \$1525 for the 2215A, \$1750 for the 2235.† Even at these low prices, there's no scrimping on performance. You

have the bandwidth for digital and analog circuits. The sensitivity for low signal measurements. The sweep speeds for fast logic families. And delayed sweep for fast, accurate timing measurements. All scopes are UL Listed and CSA approved.

You can order, or obtain literature, through the Tek National Marketing Center. Technical personnel, expert in scope applications, will answer your questions and expedite delivery. Direct orders include comprehensive 3-year warranty*, operator's

manual, two 10X probes, 15-day return policy and worldwide service backup.

**Order toll free:
1-800-426-2200,
Ask for Rick.**

In Oregon, call collect:
(503) 627-9000.
Or write Tektronix, Inc.
P.O. Box 1700
Beaverton, OR 97075

Tektronix
COMMITTED TO EXCELLENCE

SPECIAL SECTION

- 39 LOOKING AT LASERS**
A look at what lasers are and how they are put to use. **Josef Bernard**
- 42 BUILD THIS HELIUM-NEON LASER**
Now you can experiment with one of the tools of high technology. **Robert Grossblatt and Robert Iannini**

BUILD THIS

- 51 VERSATILE BENCH TOP POWER SUPPLY**
This benchtop supply offers a 0-30 volt output at up to one amp! **Greg Swain and Franco Ubaudi**
- 55 CLICK AND POP FILTER FOR YOUR STEREO**
Part 2. Give new life to your old LP's by eliminating scratches. **Joe Gorin**
- 63 HIGH-POWER FET STEREO AMP**
Here's an excellent way to upgrade your outdated system!
- 68 PC SERVICE**
Use our exclusive direct-etch foil patterns to make circuit boards for your helium-laser, click and pop filter, and power supply.

TECHNOLOGY

- 6 VIDEO NEWS**
Inside the fast-changing video scene. **David Lachenbruch**
- 47 TV SIGNAL DESCRAMBLING**
The first in a series of articles that takes a comprehensive look at the state of the art of signal scrambling and descrambling. **William Sheets and Rudolf F. Graf**
- 74 ROBOTICS**
A robot as a pet? **Mark J. Robillard**
- 75 SATELLITE TV**
The scrambling saga continues. **Bob Cooper, Jr.**

CIRCUITS AND COMPONENTS

- 32 NEW IDEAS**
A telephone answering machine
- 58 WORKING WITH VOLTAGE COMPARATORS**
Here are practical circuits you can put to work now! **Ray Marston**
- 71 DESIGNER'S NOTEBOOK**
Precision voltage rectifiers. **Robert Grossblatt**
- 72 STATE OF SOLID STATE**
A TV sync and sweep generator on a chip. **Robert F. Scott**

RADIO

- 80 ANTIQUE RADIOS**
Automatic tuning schemes
Richard D. Fitch

COMPUTERS

- Following page 84
COMPUTER DIGEST
LAN's, Lightning, GPIB, and more!

EQUIPMENT REPORTS

- 20 VIZ WD-757 Frequency Counter**
- 24 Mirage KLM JV-2X VHF Antenna**

DEPARTMENTS

- 102 Advertising and Sales Offices**
- 102 Advertising Index**
- 8 Ask R-E**
- 103 Free Information Card**
- 10 Letters**
- 82 Market Center**
- 28 New Products**
- 4 What's News**

ANNUAL INDEX

JANUARY—DECEMBER 1985

A 4-page brochure containing the 1985 Annual Index is available for those who need one. To get your free copy, send a stamped self-addressed envelope, (legal size) to:

Radio-Electronics
Annual Index
500-B Bi-County Boulevard
Farmingdale, NY 11735

Any requests postmarked on or before July 31 are free. After that date there is a 50¢ fee. Questions and comments about anything other than the index that are included with your request cannot be handled. Send them separately to our Editorial Offices.

COVER 1

Lasers have gone from science fiction to reality in only 25 years. They are used in industry, medicine, science, communications, entertainment, and more. In our special section, we'll take a look at what lasers are and how they're used. Then we'll show you how you can build a complete, portable helium-neon laser to experiment with.

The portable laser has a 1-milliwatt output and it's battery powered. It's easy to build, and a complete kit as well as separate hard-to-get parts are available. The special section starts on page 39.

NEXT MONTH

THE JULY ISSUE IS
ON SALE JUNE 3

BUILD A LOW-COST 1.2 GHz FREQUENCY COUNTER
The best way to add a new instrument to your test bench.

A ROUNDUP OF SMALL-SCREEN TV's
What's available, for how much, and what performance you can expect.

BUILD AN FET STEREO AMPLIFIER
Part 2. Upgrade your stereo system with 100 watts per channel of FET power.

BUILD A GELL-CELL CHARGER
Recharge your gell-cell batteries the right way!

As a service to readers, RADIO-ELECTRONICS publishes available plans or information relating to newsworthy products, techniques and scientific and technological developments. Because of possible variances in the quality and condition of materials and workmanship used by readers, RADIO-ELECTRONICS disclaims any responsibility for the safe and proper functioning of reader-built projects based upon or from plans or information published in this magazine.

Since some of the equipment and circuitry described in RADIO-ELECTRONICS may relate to or be covered by U.S. patents, RADIO-ELECTRONICS disclaims any liability for the infringement of such patents by the making, using, or selling of any such equipment or circuitry, and suggests that anyone interested in such projects consult a patent attorney.

Radio- Electronics.

Hugo Gernsback (1884-1967) founder
M. Harvey Gernsback,
editor-in-chief, emeritus

Larry Steckler, EHF, CET, editor-in-chief
and publisher

EDITORIAL DEPARTMENT

Art Kleiman, editorial director
Brian C. Fenton, managing editor
Carl Laron, WB2SLR, associate editor
Jeffrey K. Moltzman,
assistant technical editor
Robert A. Young, assistant editor
Julian S. Martin, editorial associate
Byron G. Webb, editorial associate
M. Harvey Gernsback,
contributing editor
Jack Darr, CET, service editor
Robert F. Scott,
semiconductor editor
Herb Friedman,
communications editor
Bob Cooper, Jr., satellite-TV editor
Robert Grossblatt, circuits editor
David Lachenbruch,
contributing editor
Richard D. Fitch,
contributing editor
Mark J. Robillard, robotics editor
Teri Scaduto Wilson, editorial assistant
Judith Kaplan, editorial assistant

PRODUCTION DEPARTMENT

Ruby M. Yee, production director
Robert A. W. Lowndes,
editorial production
Andre Durant, technical illustrator
Karen Tucker, advertising production
Geoffrey S. Weil, production traffic

CIRCULATION DEPARTMENT

Jacqueline P. Chesebrough,
circulation director
Wendy Alanko,
circulation analyst
Theresa Lombardo,
circulation assistant

Cover photo by The Image Bank

Typography by Mares Graphics

Radio-Electronics, Gernsback Publications, Inc., Executive Offices, 500-B Bi-County Blvd., Farmingdale, NY 11735, 516-293-3000

Radio-Electronics is indexed in *Applied Science & Technology Index* and *Readers Guide to Periodical Literature*.

Microfilm & microfiche editions are available. Contact circulation department for details.

Advertising Sales Offices listed on page 102.



NEW! Lower Price Scanners

Communications Electronics,[™] the world's largest distributor of radio scanners, introduces new lower prices to celebrate our 15th anniversary.

Regency[®] MX7000-EA

List price \$699.95/CE price \$399.95/SPECIAL
10-Band, 20 Channel • Crystalless • AC/DC
Frequency range: 25-550 MHz, continuous coverage and 800 MHz to 1.3 GHz, continuous coverage
The Regency MX7000 scanner lets you monitor military, F.B.I., Space Satellites, Police and Fire Departments, Drug Enforcement Agencies, Defense Department, Aeronautical AM band, Aero Navigation Band, Fish & Game, Immigration, Paramedics, Amateur Radio, Justice Department, State Department, Diva thousands of other radio frequencies most scanners can't pick up. The Regency MX7000 is the perfect scanner for intelligence agencies that need to monitor the new 800 MHz cellular telephone band. The MX7000, now at a special price from CE.

Regency[®] Z60-EA

List price \$299.95/CE price \$179.95/SPECIAL
8-Band, 40 Channel • No-crystal scanner
Bands: 30-50, 88-108, 118-138, 144-174, 440-512 MHz
The Regency Z60 covers all the public service bands plus aircraft and FM music for a total of eight bands. The Z60 also features an alarm clock and Priority control as well as AC/DC operation. Order today.

Regency[®] Z45-EA

List price \$259.95/CE price \$159.95/SPECIAL
7-Band, 45 Channel • No-crystal scanner
Bands: 30-50, 118-138, 144-174, 440-512 MHz
The Regency Z45 is very similar to the Z60 model listed above however it does not have the commercial FM broadcast band. The Z45, now at a special price from Communications Electronics.

Regency[®] RH250B-EA

List price \$613.00/CE price \$329.95/SPECIAL
10 Channel • 25 Watt Transceiver • Priority
The Regency RH250B is a ten-channel VHF/UHF mobile transceiver designed to cover any frequency between 150 to 162 MHz. Since this radio is synthesized, no expensive crystals are needed to store up to ten frequencies without battery backup. All radios come with CTCSS tone and scanning capabilities. A monitor and night/day switch is also standard. This transceiver even has a Priority function. The RH250 makes an ideal radio for any police or fire department volunteer because of its low cost and high performance. A UHF version of the same radio called the RU150B covers 450-482 MHz, but the cost is \$449.95. To get technician programming instructions, order a service manual from CE with your radio system.

NEW! Bearcat[®] 50XL-EA

List price \$199.95/CE price \$114.95/SPECIAL
10-Band, 10 Channel • Handheld scanner
Bands: 29.7-54, 136-174, 406-512 MHz
The Uniden Bearcat 50XL is an economical handheld scanner with 10 channels covering ten frequency bands. It features a keyboard lock switch to prevent accidental entry and more. Also order part # BP50 which is a rechargeable battery pack for \$14.95, a plug-in wall charger, part # AD100 for \$14.95, a carrying case part # VC001 for \$14.95 and also order optional cigarette lighter cable part # PS001 for \$14.95.



NEW! Regency[®] XL156-EA

List price \$239.95/CE price \$129.95/SPECIAL
6-Band, 10 Channel • No-crystal Scanner
Search • Lockout • Priority • AC/DC
Bands: 30-50, 144-174, 440-512 MHz
Cover your choice of over 5,000 frequencies on 10 channels at the touch of your finger. Display messages. External speaker jack. Tele-scoping antenna. External antenna jack. AC/DC.

NEW! Regency[®] R1060-EA

List Price \$149.95/CE price \$92.95/SPECIAL
6-Band, 10 Channel • Crystalless • AC only
Bands: 30-50, 144-174, 440-512 MHz
Now you can enjoy computerized scanner versatility at a price that's less than some crystal units. The Regency R1060 lets you in on all the action of police, fire, weather, and emergency calls. You'll even hear mobile telephones.

Bearcat[®] DX1000-EA

List price \$649.95/CE price \$346.95/SPECIAL
Frequency range: 10 KHz to 30 MHz
The Bearcat DX1000 shortwave radio makes tuning in London as easy as dialing a phone. It features PLL synthesized accuracy, two time zone 24-hour digital quartz clock and a built-in timer to wake you to your favorite shortwave station. It can be programmed to activate peripheral equipment like a tape recorder to record up to five different broadcasts. Any frequency, any mode, while you are asleep or at work. It will receive AM, LSB, USB, CW and FM broadcasts.

There's never been an easier way to hear what the world has to say. With the Bearcat DX1000 shortwave receiver, you now have direct access to the world.

NEW! Regency[®] HX1200-EA

List price \$369.95/CE price \$214.95/SPECIAL
8-Band, 45 Channel • No Crystal scanner
Search • Lockout • Priority • Scan delay
Side/liquid crystal display • EAROM Memory
New Direct Channel Access Feature
Bands: 30-50, 118-138, 144-174, 406-512 MHz
The new handheld Regency HX1200 scanner is fully keyboard programmable for the ultimate in versatility. You can scan up to 45 channels at the same time including the AM aircraft band. The LCD display is even side/liquid crystal display. Order MA-258-EA rapid charge drop-in battery charger for \$84.95 plus \$3.00 shipping/handling includes wall charger carrying case belt clip flexible antenna and nicad battery.

NEW! Bearcat[®] 100XL-EA

List price \$349.95/CE price \$203.95/SPECIAL
9-Band, 18 Channel • Priority • Scan Delay
Search • Limit • Hold • Lockout • AC/DC
Frequency range: 30-50, 118-174, 406-512 MHz
The world's first no-crystal handheld scanner now has a LCD channel display with backlight for low light; use and aircraft band coverage at the same low price. Size is 1 1/2" x 7 1/2" x 2 1/2". The Bearcat 100XL has wide frequency coverage that includes all public service bands (Low, High, UHF and "T" bands), the AM aircraft band, the 2-meter and 70 cm. amateur bands, plus military and federal government frequencies. Wow, what a scanner! Included in our low CE price is a sturdy carrying case, earphone, battery charger/AC adapter, six AA Ni-Cad batteries and flexible antenna. Order your scanner now.

Bearcat[®] 210XW-EA

List price \$339.95/CE price \$209.95/SPECIAL
8-Band, 20 Channel • No-crystal scanner
Automatic Weather • Search/Scan • AC/DC
Frequency range: 30-50, 136-174, 406-512 MHz
The new Bearcat 210XW is an advanced third generation scanner with great performance at a low CE price.

NEW! Bearcat[®] 145XL-EA

List price \$179.95/CE price \$102.95/SPECIAL
10 Band, 16 channel • AC/DC • Instant Weather
Frequency range: 29.54, 136-174, 420-512 MHz
The Bearcat 145XL makes a great first scanner. Its low cost and high performance lets you hear all the action with the touch of a key. Order your scanner from CE today.

TEST ANY SCANNER

Test any scanner purchased from Communications Electronics[™] for 30 days before you decide to keep it. If for any reason you are not completely satisfied, return it in original condition with all parts in 31 days, for a prompt refund (less shipping/handling charges and rebate credits).

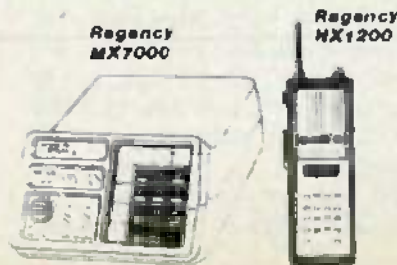

CIRCLE 79 ON FREE INFORMATION CARD

NEW! Bearcat[®] 800XL-EA

List price \$499.95/CE price \$317.95
12-Band, 40 Channel • No-Crystal scanner
Priority control • Search/Scan • AC/DC
Bands: 29-54, 18-174, 406-512, 806-912 MHz
The Uniden 800XL receives 40 channels in two banks. Scans 15 channels per second. Size 9 1/2" x 4 1/2" x 1 1/2".

OTHER RADIOS AND ACCESSORIES

- Panasonic RF-2800-EA Shortwave receiver... \$179.95
 - RD95-EA Uniden Remote mount Radar Detector... \$129.95
 - RD55-EA Uniden Vicer mount Radar Detector... \$98.95
 - RD9-EA Uniden "Passport" size Radar Detector... \$239.95
 - BC210XW-EA Bearcat 20 channel scanner SALE... \$209.95
 - BC-WA-EA Bearcat Weather Alert... \$49.95
 - DX1000-EA Bearcat shortwave receiver SALE... \$349.95
 - PC22-EA Uniden remote mount CB transceiver... \$99.95
 - PC55-EA Uniden mobile mount CB transceiver... \$59.95
 - R1060-EA Regency 10 channel scanner SALE... \$129.95
 - MX3000-EA Regency 30 channel scanner... \$198.95
 - XL156-EA Regency 10 channel scanner SALE... \$129.95
 - UC102-EA Regency VHF 2 ch. 1 Watt transceiver... \$124.95
 - RH250B-EA Regency 10 ch. 25 Watt VHF trans... \$329.95
 - RH600B-EA Regency 10 ch. 80 Watt VHF trans... \$464.95
 - RU150B-EA Regency 10 channel UHF transceiver... \$449.95
 - RP410-EA 10 ch. handheld no-crystal trans... \$399.95
 - LC10-EA Carrying case for RP410 transceiver... \$34.95
 - MA181-EA Ni-Cad battery pack for RP410 trans... \$34.95
 - P1405-EA Regency 5 amp regulated power supply... \$69.95
 - P1812-EA Regency 12 amp reg. power supply... \$164.95
 - BC10-EA Battery charger for Regency RP410... \$84.95
 - MA258-EA Drop-in charger for MX1000 & HX1200... \$84.95
 - MA257-EA Cigarette lighter cord for HX1200... \$19.95
 - MA917-EA Ni-Cad battery pack for HX1200... \$34.95
 - EC10-EA Programming tool for Regency RP410... \$24.95
 - SMRH250-EA Service manual for Regency RH250... \$24.95
 - SMRU150-EA Service manual for Regency RU150... \$24.95
 - SMRPH410-EA Service manual for Regency RP410... \$24.95
 - SMRX000-EA Service manual for MX7000 & MX3000... \$19.95
 - SMRX3000-EA Service manual for Regency MX3000... \$19.95
 - B-4-EA 1.2 V AAA Ni-Cad batteries (set of four)... \$9.95
 - FB-EA Frequency Directory for Eastern U.S.A... \$12.95
 - FB-W-EA Frequency Directory for Western U.S.A... \$12.95
 - TSG-EA Top Secret Registry of U.S. Gov. Files... \$14.95
 - TIC-EA Techniques for Intercepting Comm... \$14.95
 - RRF-EA Railroad frequency directory... \$10.95
 - CIE-EA Cover Intelligence Elect. Eavesdropping... \$14.95
 - A60-EA Magnet mount mobile scanner antenna... \$35.00
 - A70-EA Base station scanner antenna... \$35.00
 - USAMM-EA Mag mount VHF/UHF ant. w/ 12' cable... \$39.95
 - USAF-EA "hole mount VHF/UHF ant. w/ 17' cable... \$35.00
 - USATLM-EA Trunk lip mount VHF/UHF antenna... \$35.00
- Add \$3.00 shipping for all accessories ordered at the same time. Add \$12.00 shipping per shortwave receiver. Add \$7.00 shipping per scanner and \$3.00 per antenna.

BUY WITH CONFIDENCE

To get the fastest delivery from CE of any scanner, send a phone your order directly to our Scanner Distribution Center. Michigan residents please add 4% sales tax or supply your tax I.D. number. Written purchase orders are accepted from approved government agencies and most well-rated firms at a 10% surcharge for net 10 billing. All sales are subject to availability, acceptance and verification. All sales on accessories are final. Prices, terms and specifications are subject to change without notice. All prices are in U.S. dollars. Out of stock items will be placed on backorder automatically unless CE is instructed differently. A \$5.00 additional handling fee will be charged for all orders with a merchandise total under \$50.00. Shipments are F.O.B. Ann Arbor, Michigan. No COD's. Most products that we sell have a manufacturer's warranty. Free copies of warranties on these products are available prior to purchase by writing to CE. Non-certified checks require bank clearance.

Mail orders to: Communications Electronics[™], Box 1045, Ann Arbor, Michigan 48106 U.S.A. Add \$7.00 per scanner for U.P.S. ground shipping and handling in the continental U.S.A. For Canada, Puerto Rico, Hawaii, Alaska, or APO/FPO delivery, shipping charges are three times continental U.S. rates. If you have a Visa or MasterCard, you may call and place a credit card order. Order toll-free in the U.S. Dial 800-USA-SCAN. In Canada, order toll-free by calling 800-221-3475. Telex CE anytime, dial 810-223-2422. If you are outside the U.S. or in Michigan dial 313-973-8888. Order today.

Scanner Distribution Center[™] and CE logos are trademarks of Communications Electronics Inc.

† Bearcat is a registered trademark of Uniden Corporation.
‡ Regency is a registered trademark of Regency Electronics Inc. AD #040186-EA

Copyright © 1986 Communications Electronics Inc.

For credit card orders call
1-800-USA-SCAN

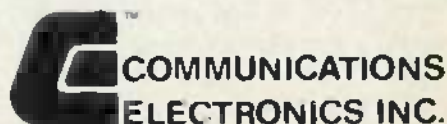

Consumer Products Division
P.O. Box 1045, Ann Arbor, Michigan 48106-1045 U.S.A.
Call 800-USA-SCAN or outside U.S.A. 313-973-8888

WHAT'S NEWS

Magnetic resonance analyzes body chemicals without penetrating skin

Using magnetic fields 30,000 times as strong as the Earth's, plus high-frequency radio signals, General Electric scientists have been able to perform a chemical analysis on the human heart by totally non-invasive means. That was made possible by a technique known as magnetic resonance.

Magnetic-resonance technology is based on the fact that, under the influence of high-power magnetic fields and high-frequency radio signals, the atomic nuclei of certain chemicals in the body tissues resonate and produce characteristic patterns of radio spectra. Those spectra can be used to identify the presence of those chemicals. That is useful in medical diagnosis because the spectra from diseased human tissues may differ markedly from those produced by normal tissue.

Magnetic-resonance spectroscopy is a further development of magnetic resonance imaging, developed in 1984, which is used to produce images of internal body-structures. The techniques that made the present breakthrough possible include stronger magnetic fields—up to 1.5 tesla—and depth-resolved surface coil spectroscopy. The latter is a specialized localization method that makes it possible to select resonance signals from the heart or other organ and isolate them from signals from surrounding tissues. That was done with the help of a specially developed surface coil placed directly over the heart. It



MAGNETIC FIELDS OF 1.5 TESLA enable scientists to analyze chemicals deep in the human body by non-invasive means. Dr. Paul A. Bottomley, General Electric physicist, examines a spectrogram made with the help of such fields, which are 30,000 times as strong as those of the earth's. Made with a surface coil placed against the body, those analyses may allow doctors to diagnose illnesses faster and more accurately than previously possible.

both emits the signals that excite the heart's chemicals and picks up the faint resonance signals that result.

In a magnetic-resonance examination, the patient is positioned within the circular bore of a powerful magnet and probed with high-frequency radio signals. Under the influence of the magnetic field, the waves cause the nuclei of selected atoms to resonate and produce faint radio signals. These are picked up by the coil and transmitted to a sophisticated image-processing computer for interpretation. The computer then generates a spectrum showing the relative amounts of the various chemicals in the organ being studied.

Radio stations receive digital-stereo broadcast

The nation's first direct-to-local station live digital-stereo broadcast was launched by Radio WGBH, Boston, early last November. The program, an all-Ravel concert by Switzerland's Or-

chestre de la Suisse Romande, originated at the Kresge Auditorium of the Massachusetts Institute of Technology and was beamed live to public-radio stations across the country.

The concert's analog right and left audio-outputs went into two

dbx Model 700 digital audio-processors. The video-format digital-audio signals were then fed to a videocassette recorder and to a modulator on the M.I.T. cable-television system. It then went by microwave link to the Harvard Information Transmission System at Harvard University, which relayed it to WGBH.

The digital-audio signals were then fed to two dbx 700's in WGBH-FM's control room. Their video output went, via WGBH master control and a 7-GHz microwave link, to WGBH's satellite-uplink facilities in Needham, MA. The program was retransmitted on PBS's Westar IV satellite transponder 10-D.

Motorola joins campaign against drunk driving

Drawing on earlier experience with citizen-driver radio organizations, Motorola has announced a program to help fight drunk driving. The program was announced at a statewide conference of concerned citizens and organizations, including the Illinois State Police, the Illinois Department of Transportation, and the National Committee Against Drunk Driving. The conference was organized by AAIM, the Alliance Against Intoxicated Motorists.

Called DADD (*Drivers Against Drunk Drivers*), the Motorola program will help to educate and encourage drivers whose vehicles are equipped with cellular telephones to identify signs of drunk driving and to instruct them in reporting the incidents to appropriate law enforcement agencies.

The program will begin, says Motorola spokesman David Weischz, by packing information with each cellular telephone sold by the company. In addition, tips such as using the memory features on a cellular telephone to store key emergency numbers would be provided to get the cellular users started. **R-E**



ELECTRONICS, INC.

New and Used Electronic Test Equipment
Sales • Service • Rental • Leasing

HITACHI 3.5 Digit DMM *Free* With Scope Purchase



FEATURES:

- AC DC voltage
- AC DC current
- Resistance
- Diode test
- Audible Continuity check
- Temperature (Type K, 3510 & 3525)
- Data hold
- Manual or autoranging
- Overload protection
- LCD display
- Built-in stand
- Battery included
- Test leads included

Special!

MODEL	BASIC DC VOLTAGE ACCURACY	QTY 1 PRICE	QTY 3+ PRICE	One With Any Scope Purchased From RAG
				FREE
3550	±5% ±2 digits	\$49.00	\$42.00	FREE
3525	±.25% ±2 digits	\$64.00	\$54.00	\$19.95
3510	±.1% ±2 digits	\$79.00	\$67.00	\$29.95

2 year warranty plus carrying case included!



Model V-422 shown

MODEL V-222 \$536.00
DC to 20 MHz, 1 mV/div, Dual Trace, D.C. offset for DMM Output, Vertical Mode Trigger, 6" CRT (w/two X1/X10 probes).

MODEL V-422 \$694.00
DC to 40 MHz, other features same as V-222 (w/two X1/X10 probe).

MODEL V-1050F \$1,276.00
DC to 100 MHz, 5 mV/div, Quad Trace, Delayed Sweep, Full T.V. Triggering, alternate time base (w/two X1/X10 probes).

MODEL V-212 \$461.00
DC to 20 MHz, 1 mV/div, Dual Trace, Features 6" Rectangular CRT (w/two X10 probes).



MODEL V-650 \$956.00
DC to 60 MHz, 1 mV/div, Triple Trace, Delayed Sweep, Full T.V. Triggering, variable trigger hold-off (w/two X1/X10 Probes).

NEW! 3 year warranty parts and labor on above scopes!

RAG Electronics is a factory authorized Hitachi repair center.

CIRCLE 126 ON FREE INFORMATION CARD

CALL US TOLL FREE
1-800-732-3457
IN CALIFORNIA TOLL FREE
1-800-272-4225

<ul style="list-style-type: none"> ■ Master Charge ■ VISA ■ COD ■ Money Order ■ Check 	 	ADD FOR SHIPPING AND INSURANCE \$0 to \$250.00 \$4.50 \$251.00 to \$500.00 \$6.50 \$501.00 to \$750.00 \$8.50 \$751.00 to \$1000 \$12.50 over \$1000.00 \$15.00
---	--	---

Prices subject to change without notice.

RAG ELECTRONICS, INC. / 21418 Parthenia Street / Canoga Park, CA 91304 / 1-818-998-6500

VIDEO NEWS



DAVID LACHENBRUCH
CONTRIBUTING EDITOR

• **Philips' Flat Tube.** Another flat video-display device has been announced. Developed by Philips, in that company's British laboratories, the new device is a cathode ray tube three inches thick with a picture display measuring 12 inches diagonally.

The tube itself is in a metal can to which a glass faceplate is sealed. The electron beam travels from a single gun at the top rear of the tube and down the back of the tube to a reversing lens, which turns it 180 degrees, deflecting it to the front of the tube. Frame deflection plates create a field that turns the beam forward to an electron multiplier that amplifies the current several hundred times, accelerating the beam to the phosphor screen. Philips says resolution and gray scale are "appropriate for television applications," but adds that the first uses are likely to be in professional applications such as data display. The system has inherently high picture brightness and requires only low deflection voltages. Philips believes that the ultimate design will use a single gun and a sequential color display.

• **1,000,000 projection TV's.** This is a landmark year for the slow but steadily growing projection television market—the year the 1,000,000th set will be sold. That's the forecast of U.S. Precision Lens, Inc., the main manufacturer of projection TV optics. Sales have been increasing gradually each year as quality improves, sets get more compact, and prices come down. USPL says 90 percent of all projection TV's sold last year were of the rear-projection variety (in which the picture is thrown from within the set onto a translucent screen at the front of the cabinet). Of those, 62 percent were in the "smaller"-screen category (36 to 41 inches diagonally), while 38 percent had pictures measuring 45 to 50 inches.

• **Digital VTR's on sale.** The first digital videotape recorders are now being offered for sale to television broadcasters. Sony started taking orders in April at the National Association of

Broadcasters convention for the new world standard D-1 VTR. That system has been approved by world broadcasting bodies as the standard for broadcast recorders and is switchable between 525- and 625-line standards. It uses tape that is 19-mm wide (about ¾ inch). Deliveries of the recorders will start early next year. The price wasn't available at press time.

Also at the broadcaster's convention, Ampex offered a digital cartridge-type VTR, designed especially for automated playing of short segments, such as commercials. Although a digital recorder, Ampex's cart machine doesn't use the standardized world system. The introduction of digital video recorders is regarded as a quantum leap forward in recording quality, and a new bridge between different countries' TV standards, since it is the first time that a single machine can be used to record both 525- and 635-line systems.

• **Cable-ready OK.** The federal district court in Pittsburgh has upheld the legality of cable-ready tuning devices by turning back a challenge by two Pennsylvania cable systems. Shenango Cable TV and an affiliate, Variety Cable TV, both of Sharon, PA, sued Tandy Corporation, parent of Radio Shack, charging that their Archer block converter illegally intercepts and pirates cable channels in violation of federal law.

Block converters, like cable-ready TV sets, change cable channels to UHF frequencies for reception without the use of cable converter boxes. The two Sharon PA cable systems didn't encode or trap their premium programs but merely put them on special cable channels and supplied converter boxes to subscribers ordering them. In throwing out the challenge, Judge Paul Simmons ruled that the block converter wasn't intended as a piracy device, that it wasn't used to tap illegally into the cable systems, and noted that if the systems had trapped or scrambled their signals, those devices wouldn't have been able to violate their security. The case was the first known challenge of its kind, and the decision is regarded as a legal precedent. **R-E**

How to beat the high cost of cheap meters.



You get what you pay for.
So get the Fluke 70 Series.

You'll get more meter for your money, whether you choose the affordable 73, the feature-packed 75 or the deluxe 77.

All of them will give you years of performance, long after cheaper meters have pegged their fishhook needles for the last time.

That's because they're built to last, inside and out. So they're tough to break. They don't blow fuses all the time. You don't even have to replace batteries as often.

And they're backed by a 3-year warranty. Not the usual 1-year.

Of course, you may only care that the world-champion 70 Series combines digital and analog displays with more automatic features, greater accuracy and easier operation than any other meters in their class.

You may not care that they have a lower overall cost of ownership than all the other "bargain" meters out there.

But just in case, now you know.

For a free brochure or your nearest distributor, call toll-free 1-800-227-3800, ext. 229.

FROM THE WORLD LEADER IN DIGITAL MULTIMETERS.



FLUKE 73

\$79*
 Analog/digital display
 Volts, ohms, 10A, diode test
 Autorange
 0.7% basic dc accuracy
 2000+ hour battery life
 3-year warranty

FLUKE 75

\$99*
 Analog/digital display
 Volts, ohms, 10A, mA, diode test
 Audible continuity
 Autorange/range hold
 0.5% basic dc accuracy
 2000+ hour battery life
 3-year warranty

FLUKE 77

\$139*
 Analog/digital display
 Volts, ohms, 10A, mA, diode test
 Audible continuity
 Touch front function
 Autorange/range hold
 0.3% basic dc accuracy
 2000+ hour battery life
 3-year warranty
 Multipurpose holder

* Suggested U.S. list price, effective November 1, 1985
 ** Patent pending

IN THE U.S. AND NON-EUROPEAN COUNTRIES: John Fluke Mfg. Co., Inc., P.O. Box C8080, M/S 2500, Everett, WA 98208. Sales (206) 358-5400. Other (206) 347-6100.
 EUROPEAN HEADQUARTERS: Fluke (Holland) B.V., P.O. Box 2208, 5600 CG Eindhoven, The Netherlands. (040) 450415. TLX 51446.
 © Copyright 1985 John Fluke Mfg. Co., Inc. All rights reserved. Ad No. 9734-70

CIRCLE 121 ON FREE INFORMATION CARD



JUNE 1986

ASK R-E

WRITE TO:

ASK R-E
Radio-Electronics
500-B Bi-County Blvd.
Farmingdale, NY 11735

WORLD TIME CONVERSION

Some foreign shortwave broadcasters announce time in Greenwich Mean Time (GMT); WWV announces time in Coordinated Universal Time (UTC); and I've heard some hams use Zulu Time. What is the relationship between these systems, and how can I convert each to local time?—W. W., White Plains, NY

The three systems are based on a 24-hour clock and they're virtually identical. Greenwich Mean Time is a global standard based on local (standard, not daylight) time in Greenwich, England; GMT is the basis for the other time-keeping systems. In the GMT system, midnight is both 2400 and 0000 hours. The former is associated with the day just ending, and the latter is associated with the day just beginning.

GMT divides the earth into twenty-four time zones. Each zone covers 15 degrees of longitude. Each zone is assigned a number equivalent to the number of hours later (+) or earlier (-) than GMT.

So, moving west from the Greenwich meridian, local time lags one hour behind GMT for each 15 degrees of longitudinal change, until at 180 degrees—the international Date Line—time is 12 hours behind GMT west of the Date Line, and 12 hours ahead of GMT east of the Date Line. Five zones west of Greenwich brings us to 75 degrees longitude, or the center of the Eastern Standard Time zone. The Central Standard, Mountain and Pacific Time zones are centered on 90 degrees, 105 degrees, and 120 degrees, respectively. Those time zones are 5, 6, 7, and 8 hours, respectively, behind GMT.

TABLE 1—TIME ZONE CONVERSION

UTC	EDT/AST	CDT/EST	MDT/CST	PDT/MST	PST
0000*	2000	1900	1800	1700	1600
0100	2100	2000	1900	1800	1700
0200	2200	2100	2000	1900	1800
0300	2300	2200	2100	2000	1900
0400	0000*	2300	2200	2100	2000
0500	0100	0000*	2300	2200	2100
0600	0200	0100	0000*	2300	2200
0700	0300	0200	0100	0000*	2300
0800	0400	0300	0200	0100	0000*
0900	0500	0400	0300	0200	0100
1000	0600	0500	0400	0300	0200
1100	0700	0600	0500	0400	0300
1200	0800	0700	0600	0500	0400
1300	0900	0800	0700	0600	0500
1400	1000	0900	0800	0700	0600
1500	1100	1000	0900	0800	0700
1600	1200	1100	1000	0900	0800
1700	1300	1200	1100	1000	0900
1800	1400	1300	1200	1100	1000
1900	1500	1400	1300	1200	1100
2000	1600	1500	1400	1300	1200
2100	1700	1600	1500	1400	1300
2200	1800	1700	1600	1500	1400
2300	1900	1800	1700	1600	1500
2400*	2000	1900	1800	1700	1600

*0000 and 2400 are interchangeable. (2400 is associated with the date of the day ending, 0000 with the day just starting.)

So, to convert GMT to local North American time, subtract a number of hours from your local time equal to your zone number. For example, midnight (2400 hours) in Greenwich is, on the east coast, 24 - 5 = 19, or 1900 hours. Or you can use the time-conversion chart in Table 1 to convert local (U. S.) time to and from GMT. Readers in Europe or Asia who live east of the Greenwich meridian should add their zone number to GMT to get local time.

If you're an SWL (Shortwave Listener), you have to be careful when you make your reception reports. For example, assume you

heard a BBC broadcast on Friday evening between 8:00 and 9:00 pm EST. EST is 5 hours behind GMT, so the program was actually broadcast between 0100 and 0200 GMT on Saturday—the next day. Hence your reception report should list Saturday, not Friday, as the day you heard the broadcast.

As to the relationship between GMT, UTC and "Zulu" time: UTC is a 24-hour time system that is based on the GMT. It is coordinated by the International Time Bureau (BIH) through international agreements so that the standard time signals broadcast by WWV (in the U. S.), CHU (Ottawa, Canada), LOL (Buenos Aires, Argentina), and JJJ (Tokyo, Japan) will closely agree.

For convenience in specifying time at various places around the globe, the military assigned an identifying letter to each of the twenty-four time zones. The letter "Z" (phonetically, *Zebra* or *Zulu*) was assigned to the time zone around the prime meridian. So, in some circles, GMT came to be called Zebra or Zulu time.

ZERO CROSSING

What is meant by "zero-crossing" as applied to relays and opto-couplers?—S. S. K., Brooklyn, NY

Zero-crossing (also called zero-voltage switching) refers to the practice of applying AC power to a load at the instant that the voltage crosses the "zero" point in the AC cycle. Doing that allows the operating current to rise gradually with the applied voltage. When power is applied to the device at any voltage other than zero, the load current abruptly surges from zero to a high value limited only by the impedance of the load. That current

continued on page 79

PERFORMANCE

THAT IS OUT OF THIS WORLD...



\$389⁰⁰

**MODEL 2000 20MHz
DUAL TRACE**

\$549⁰⁰

**MODEL 3500 35MHz
DUAL TRACE DELAYED SWEEP**

...AT A DOWN TO EARTH PRICE

At last! Truly affordable test equipment with no compromise in design, and features you would expect to find only on oscilloscopes costing hundreds of dollars more! JDR Instruments presents two, new, high-performance models backed by a two year warranty and technical support which is only a phone call away. Perfect for the technician or advanced hobbyist, both models feature Dual Trace capability and a variety of operating and triggering modes, including CH-B Subtract and X-Y operation.

MODEL 2000 has a 20 MHz bandwidth and 20 calibrated sweeps ranging from .2s to .2 μ s. A convenient built-in component tester provides additional diagnostic power.



INCLUDES TWO HIGH QUALITY
1x, 10x TEST PROBES

MODEL 3500 features a 35 MHz bandwidth and exceptional 1mV/DIV sensitivity. Delayed sweep and variable holdoff allow stable viewing of complex waveforms.

CIRCLE 59 ON FREE INFORMATION CARD

ORDER TOLL FREE
800-538-5000
800-662-6279 (CA)



JDR INSTRUMENTS
1224 South Bascom Avenue
San Jose, California 95128 (408) 995-5430

COPYRIGHT 1985 JDR INSTRUMENTS. EARTH PHOTO COURTESY OF NASA.
THE JDR INSTRUMENTS LOGO IS A REGISTERED TRADEMARK OF JDR MICRODEVICES. JDR INSTRUMENTS IS A TRADEMARK OF JDR MICRODEVICES.

LETTERS

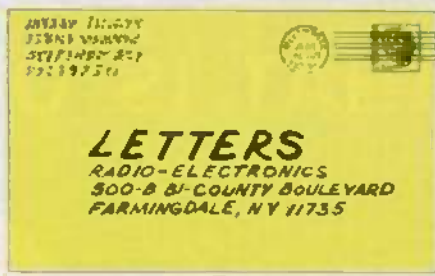

DON'T ENLARGE COMPUTER DIGEST

In the March 1986 "Computer Digest" part of Radio-Electronics a reader asks for more pages in that section. I have a strong response to that request.

Computer magazines come and go; few are cherished or missed. Radio-Electronics is the last of the oldtimers for the hardware hacker. One or two new ones exist, but Radio-Electronics is the granddaddy of them all.

If you want to read about computers, get the computer maga-

zines (as I do). If you want the best in general electronics, then get Radio-Electronics and don't push it into extinction.

And you other Radio-Electronics fans: I urge you to speak up, because I have a feeling that Radio-Electronics is on the endangered-species list. I've been an unfailing subscriber for too many years to let it go without a fight!

RICK MCGUIRE
Trenton, NJ

Don't worry, Rick. Radio-Electronics is not on any endangered-species list. We'll be here covering

circuits, technology, video, and even computers for years to come.—Editor

OOOOOPS!

It seems that we played an April Fool's joke on ourselves in the article "Build This Telephone Line Tester," which appeared in the April 1986 issue. First of all, the schematic that accompanied that article was incorrect; the correct schematic appears here as Fig. 1.

Secondly, there are two resistors identified as R6. The resistor located at the anode of D5 is actually

NEW!



From
W.S. JENKS & SON

**Weller®
WTCPR \$77.50**

Safe for IC soldering. Closed loop, low-voltage circuit automatically controls output. 700 F 1/16" screwdriver tip provided. 600 F and 800 F tips available. Power unit has non-heat sinking iron holder, storage tray for extra tips and tip cleaning sponge with receptical. Send for free W.S. Jenks & Son electronics tool catalog for complete accessories.



W.S. JENKS & SON

2024 West Virginia Ave. NE
Washington, D.C. 20002
TOLL-FREE ORDER LINE: 1-800-638-6405

Please send the indicated material:
 Weller WTCPR Soldering Station @ \$77.50
 FREE W.S. Jenks & Son Catalog
 Check/Money Order
 MasterCard Visa Am. Exp.

Card No. _____ Exp. _____
 Signature _____
 Name _____
 Address _____
 City _____ State _____ Zip _____
 VA residents add 4% tax. DC residents add 6% tax.

SEND NOW!

FREE CATALOG!
Over 100 pages. Wide selection of tool sets, test equipment, soldering and desoldering equipment, telecommunications and specialized electronics assembly tools.

Put Your Electronic Skills to Work UNDERWATER!

BECOME A ROBOT VEHICLE PILOT/TECHNICIAN



Accredited by NITTS
Approved for training of Veterans
Approved for Veterans Loan & Grant Programs

HIGH PAY—WORLDWIDE TRAVEL

Call or Write Today for FREE BROCHURE

CALL (212) 885-0600

UNDERWATER VEHICLE TRAINING CENTER
10046 CHICKASAW, HOUSTON, TX 77041
IN TEXAS CALL: 713-690-0405, TELEX 4620684

CIRCLE 119 ON FREE INFORMATION CARD

RADIO-ELECTRONICS

FORDHAM WILL BEAT ANY ADVERTISED

B&K LEADER HITACHI AW SPERRY NON-LINEAR BBC

OSCILLOSCOPE PRICE

by \$25⁰⁰

No ifs, ands or buts.

Copyright © Fordham 1985

Must be a currently advertised price.
This offer may be withdrawn at any time without prior notice.

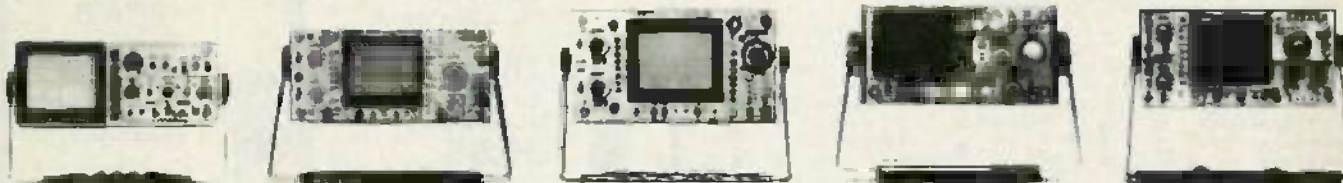

ASK FOR FREE CATALOG.

Money orders, checks accepted. C.O.D.'s require 25% deposit.



Fordham

Toll Free

800-645-9518

260 Motor Parkway, Hauppauge, NY 11788

In NY State 800-832-1446

Service & Shipping Charge Schedule
Continental U.S.A.

FOR ORDERS	ADD
\$25-\$100	\$4.50
\$101-\$250	\$6.00
\$251-500	\$8.00
\$501-750	\$10.50
\$751-1,000	\$12.50
\$1,001-1,500	\$16.50
\$1,501-2,000	\$20.00
\$2,001 and Up.	\$25.00

JUNE 1985

11

SEE YOUR DEALER TODAY

FROM

Firestik
ANTENNAS
ACCESSORIES

HERE'S A TIP
THAT'S PERFECT!

AM/FM AUTO RADIO
AND CB

Firestik II
GOLDEN SERIES

BARE-HANDS TUNABLE
"NO TOOLS NEEDED"
HIGH PERFORMANCE ANTENNAS

ALSO ANTENNAS FOR
CORDLESS TELEPHONES
MONITOR SCANNERS

Dealer & Distributor Inquiries Invited
SEND FOR FREE CATALOG

Firestik Antenna Company
2614 East Adams Phoenix, AZ 85034

Name _____
Street _____
City _____
State _____ Zip _____

Serving the CB and
Communications Market Since 1962.

5-YEAR REPLACEMENT WARRANTY

CIRCLE 100 ON FREE INFORMATION CARD

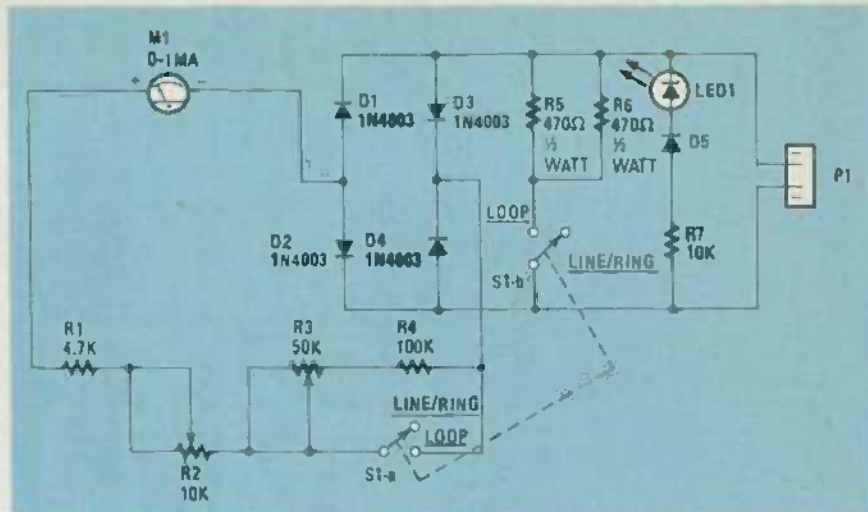

FIG. 1

R7; it is a 10K unit as originally shown.

Finally, in the parts-placement diagram, diodes D1, D3 and LED1 were shown installed backward.— Editor.

TELETEXT REMOTE SCHEMATIC

It seems that April's gremlins also drew the remote-control circuit

(Fig. 8) in the story "Build This Teletext Decoder." The front end of the receiver circuit, which is shown inside the dashed box in the figure, has a few mis-labeled components. For example, R70 should be 680 ohms. The 0.047- μ F capacitor between ground and chassis should have been labeled C48, and the capacitor directly above it should

**PRB ... HAS OVER 10,000
ELECTRONIC COMPONENTS**

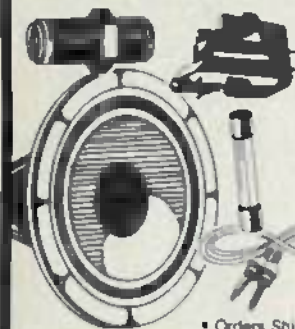

PROJECTOR RECORDER BELT has virtually every electronic component you'll ever need . . . plus . . . the world's most complete inventory of belts (including the hard to find ones).

PRB OFFERS YOU:

- Everyday Low Prices
- FREE Freight (PRB will pay the 1st lb. of UPS-ground only-charge)
- Orders Shipped within 24 Hours
- 100% Guarantee on All Products
- Weekly Specials for Super Savings
- Service You Can Depend On
- FREE - 98 Page Catalog (call for your copy)

SPECIALS

- INDIVIDUAL 5 1/4" RAINBOW MEMORIES DISKETTES (Bulk) Single Sided #1SBK Just \$1.17 ea. (min. 12) (1-11 \$1.30 Each) Double Sided #2SBK Just \$1.26 ea. (min. 12) (1-11 \$1.40 Each)
- WASH PLUS Powerful spray degreaser/tuner & video tape head cleaner. Sale for all plastics. #2404 24 oz. aerosol can Regularly \$4.20 SALE \$3.75 (12 & UP \$3.40 Each)
- VOLTAGE SPIKE PROTECTOR with radio noise filter #4445P Close-Out Special! Regularly \$6.15 SALE \$1.95 (min. 12)

ORDER TOLL FREE

National 1-800-558-9572 In Wisconsin 1-800-242-9553 TOLL: 4994411 PRB USA



PROJECTOR RECORDER BELT
200 Clay Street
Whitewater, WI 53190

CIRCLE 193 ON FREE INFORMATION CARD

Call us FREE **1-800-626-6343**
or write for FREE Flyer.

COPPER ELECTRONICS

4200 PRODUCE ROAD - LOUISVILLE, KENTUCKY 40218



40-Channel Mobile CB

Retail \$69.95 **34.95**



Tenna
5-Way Speaker System
7 1/2 x 4 1/2 x 4 1/2"

Retail \$79.95 **27.95** Pair

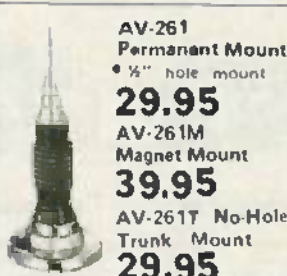

AV-261 Permanent Mount • 1/2" hole mount **29.95**
AV-261M Magnet Mount **39.95**
AV-261T No-Hole Trunk Mount **29.95**



Under Beach
BC100XL
Programmable Handheld Scanner
Retail \$329.95 **199.95**

THE LOWEST PRICES IN THE COUNTRY!
We have a national factory warranty service on many brands, and we service All CB, Amateur, and Commercial Equipment.

CIRCLE 125 ON FREE INFORMATION CARD

RADIO-ELECTRONICS

Electricity and water don't mix. At least not in our Heavy Duty Digital Multimeters. Because these Oops Proof™ instruments are protected by a system of seals to ensure contamination-free dependability in even the cruddiest conditions.

Other abuse-proof features include the best mechanical protection ever built into a precision Digital Multimeter. In fact, every one of our Oops Proof multimeters will survive a drop from ten feet onto a concrete surface!

All the Heavy Duty series meters measure up to 1000 volts AC and 1500 volts DC, with full overload protection to those maximum voltages even on the lowest range settings. Overload circuitry also provides transient protection to 6KV on all voltage ranges and up to 600 volts on all resistance ranges.

We also invented a unique, long-life rotary switch for our Digital Multimeters. You can actually feel the difference just by

rotating the function selector knob.

You'll find these features in a full line of Heavy Duty DMMs that offer a 4 1/2 digit readout, 0.05% VDC accuracy, a 10 amp current range, a 2000-hour battery life, diode test, true RMS and temperature measurement. All this and a no-questions, one-year warranty.

You'll want to try one out, of course, so drop into your nearest electronics distributor and drop one.

Our lips are sealed.

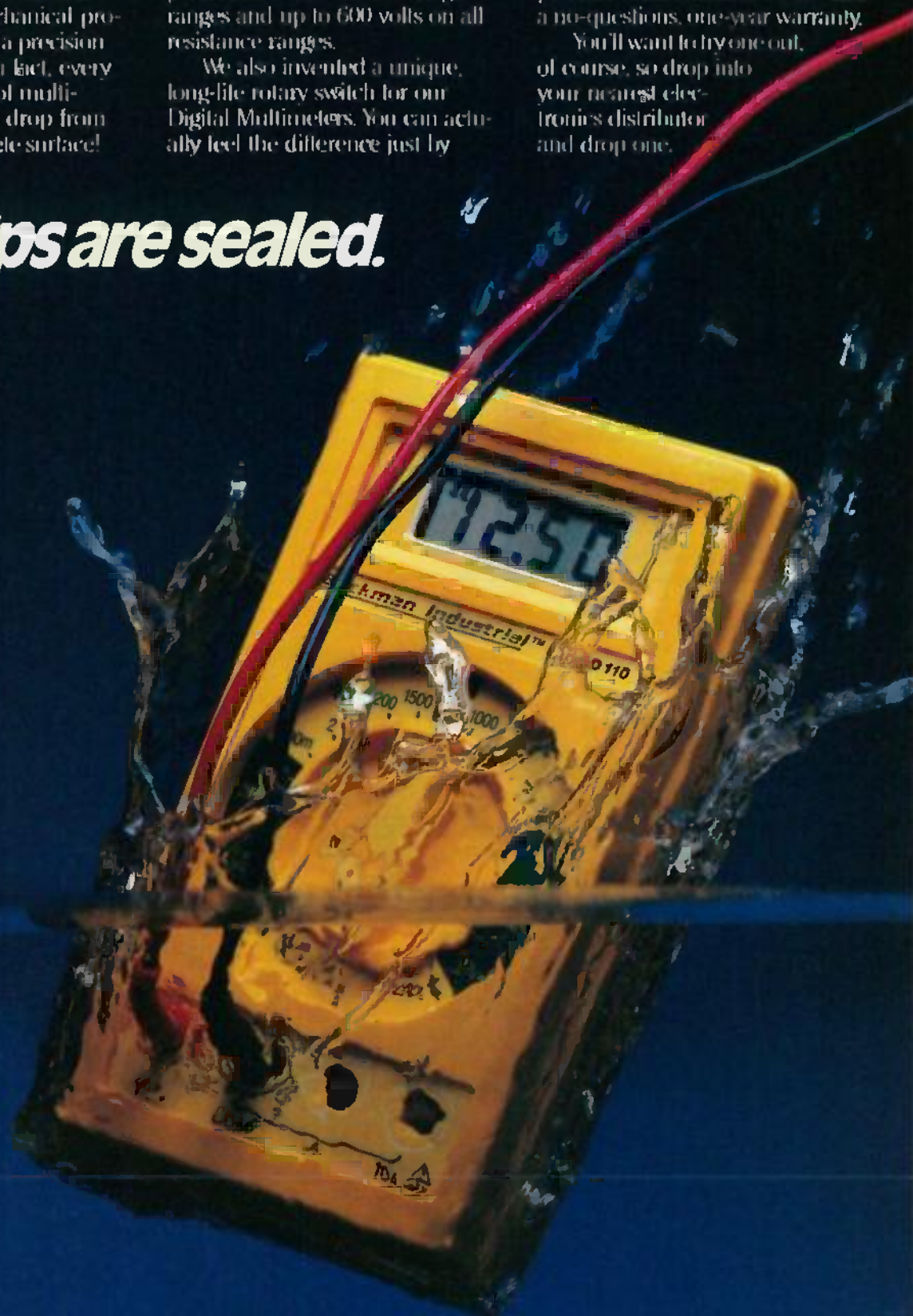

© 1985 Beckman Industrial Corporation, A Subsidiary of Emerson Electric Company,
630 Priente Street, Brea, CA 92621 (714) 671-1800.

Beckman Industrial™

CIRCLE 177 ON FREE INFORMATION CARD

Learn micro-processing with the new
MICRO-PROFESSOR 1P



Students, engineers or technicians—
upgrade your micro-processing skills
with the new Micro-Professor 1P.

The MPF-1P features:

- extensive software support
- more built-in memory
- improved keyboard
- larger display

Three tutorial guides help cover all
capabilities. The ideal training tool!
MPF-1P will deliver you into the growing
world of micro-processing. Invest now!

Plus—FREE GIFT Only \$199.95

Check this box for FREE
2-80 Microprocessor
Programming and
Interfacing textbook when
you order within 7 days.
\$12.95 value. (Include
\$5.00 postage &
handling)

ETRONIX

Dept RE0686
3326 9th Ave. N.E.
Seattle, WA 98105-3617

For immediate action call TOLL FREE:

1-800-426-1044

Full money back guarantee.



CIRCLE 111 ON FREE INFORMATION CARD

have been labled C47, 47 μ F. Unfortunately, that's not all. The anode of LED3 should, of course, go to +12 volts, and the 1K resistor in series with it should be labled R71.—Editor

CHANGES IN THE SAM MODEL 3001

The review in December 1985's "Computer Digest" of HiTech's SAM 3001 was very well done. We at HiTech would like to take this opportunity to thank you for your comments

The system reviewed was actually delivered this past August (1985) when it was still relatively new. Since then, there have been a few changes. Our motherboards feature a clock speed of 8MHz. Instead of 640K we now offer 1MB RAM; and a 30MB voice-coil hard-disk drive has replaced the 20MB hard disk. Despite all of those enhancements, the \$4395.00 list price remains the same.

The power-on-reset problem was attributed to lack of proper documentation. That was over-

looked in our attempt to meet the initial market demand for out AT compatibles. Since its revision, the manual that accompanies the unit now fully illustrates the change in the reset circuits.

As for the floppy-disk drive, we have indeed switched over to Mitsubishi Electronics as our supplier of drives. As of now, all SAM 3001's come equipped with the Mitsubishi M148 1.2MB floppy.

Again we thank Radio-Electronics' staff for the review of our product.

KENNETH KIM,
President, HiTech International,
Inc.

SCHEMATIC NEEDED

I recently acquired a Motorola TV, no. VT71M-A that was manufactured in 1949. I would like to rebuild the chassis, but cannot find a schematic. I've tried Sams and Motorola. Can you or your readers help me?

JOHN PANISTER
2 Signal Hill Rd.,
Cherry Hill, NJ 08003

R-E

Send Purchase Order
Check, Money Order, or C.O.D.
or Call Toll Free
800-223-0826
in N.Y. State (212) 865-5580

Nobody Beats Us!
\$69.95



**JERROLD CORDLESS
CABLE T.V. CONVERTER**

Model DRX3-105/400 (58 CHANNELS)
ALSO AVAILABLE TEKNICA - Model 6510 with volume control \$139.95

CO-AXIAL CABLE

Braided bare
Copper Shield

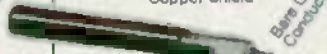

Bare Copper
Conductor

RG 59/u

\$44.50/1000

Foam
polyethylene
dielectric

RG-6/u 69.95/1000

Add \$5.00 per Roll for Shipping

SANYO **TOSHIBA**
2SC1308K **2SC1172B**
ORIGINAL ORIGINAL
\$1.49
100 up
10-29 11-99 30-99 11-00

\$10.99
each
RCA
Triplers
SK3308/Equivalent to ECG-523
ECG-526
SK3304/Equivalent to ECG-500A

**2 WAY - 75 ohm u/v
Splitter**
49c/100 lot
99c each
21c/100 lot
**MATCHING
TRANSFORMER**

"F" - FITTINGS
F-59ALM with attached
1/2" ring for RG-59/u cable
12e/100 9e/100 0 **7c/5000**
F-56ALM with attached
1/2" ring for RG-8/u cable
15e/100 10e/100 0 **8c/5000**

WELLER
WTCPA CONTROLLED OUTPUT
SOLDERING STATION
Model
WTCP-R
\$69.95

**HITACHI 20 Mhz Dual
Trace Scopes**
V-212-**\$439.95** Probes
V-222-**\$489.95** included
V-223-**\$539.95** DELAYED SWEEP

OMNITRON
ELECTRONICS
770 Amsterdam Ave., New York, NY 10025
SHIPPING CHARGES
For Orders Add
\$25-100 \$6.50
\$100-500 \$8.50
\$500-750 \$10.50
\$750 and up \$20.00



CALL TOLL FREE

CALIFORNIA 800-772-1519
OTHER STATES 800-854-1519

IN SAN DIEGO CALL
619-560-9676

**FREE
CATALOG!**



**PROBE
MASTER**

**YOUR SINGLE SOURCE
FOR PROBES
AND ACCESSORIES**

BNC ADAPTER KIT \$59
10 PIECE KIT



MODULAR SCOPE PROBES \$36 & UP

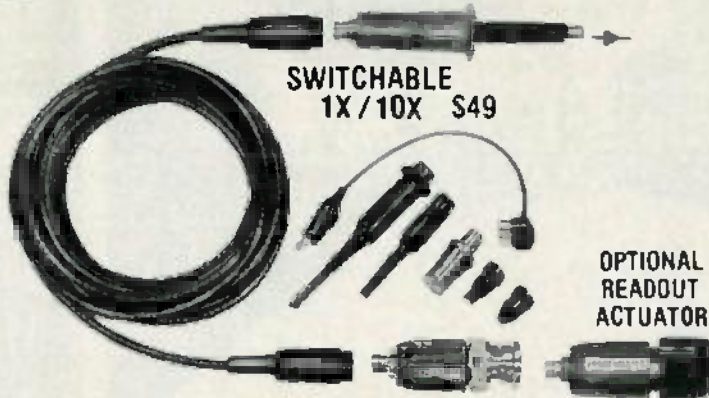

SWITCHABLE
1X/10X \$49

OPTIONAL
READOUT
ACTUATOR

DESIGNER TEST LEAD KIT \$15
(LEADS ONLY \$6.90)

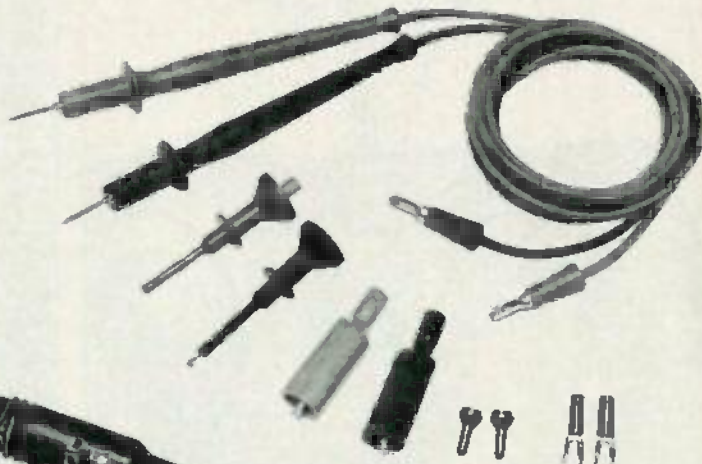

**TERMINATIONS &
ATTENUATORS \$19 & UP**

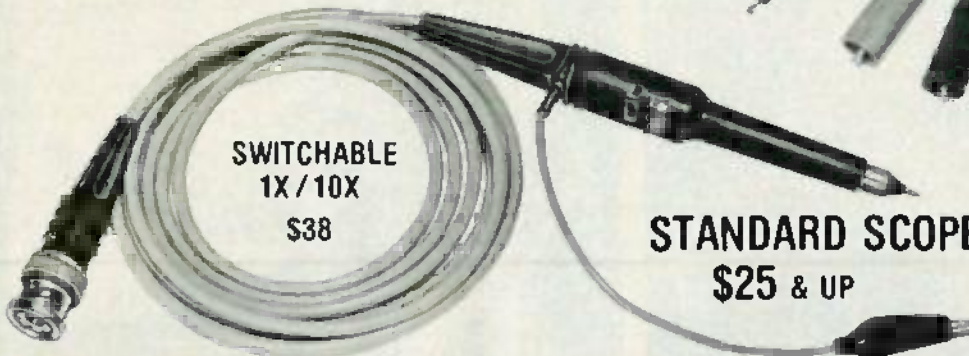

SWITCHABLE
1X/10X
\$38

**STANDARD SCOPE PROBES
\$25 & UP**

**IMMEDIATE DELIVERY
CALL FOR NEAREST DISTRIBUTOR**



**PROBE
MASTER**

4898 RONSON CT.
SAN DIEGO, CA 92111

JUNE 1986

CIRCLE 96 ON FREE INFORMATION CARD

15

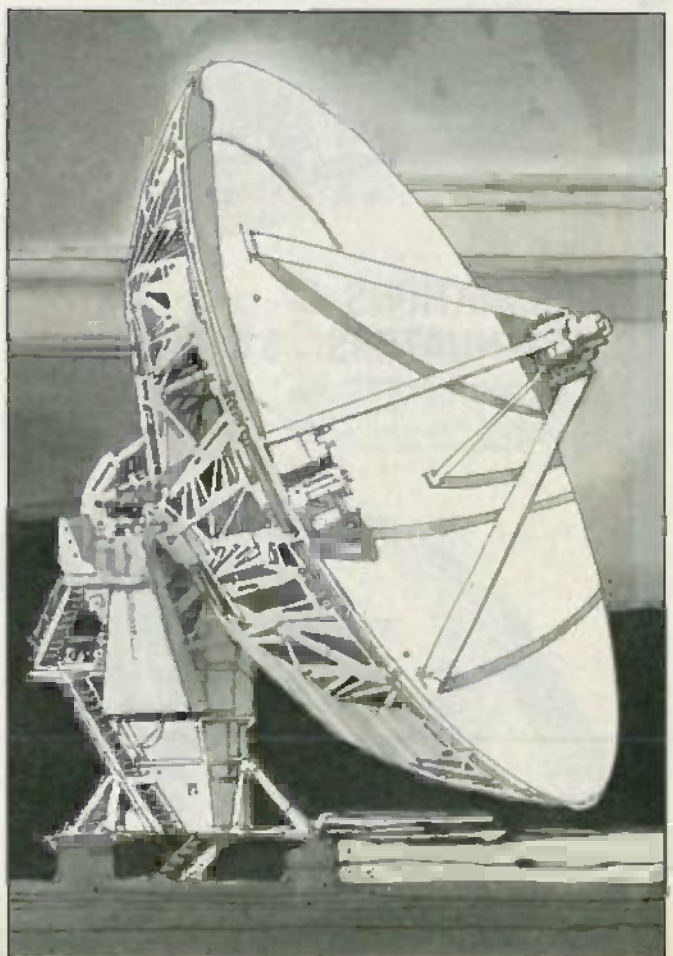
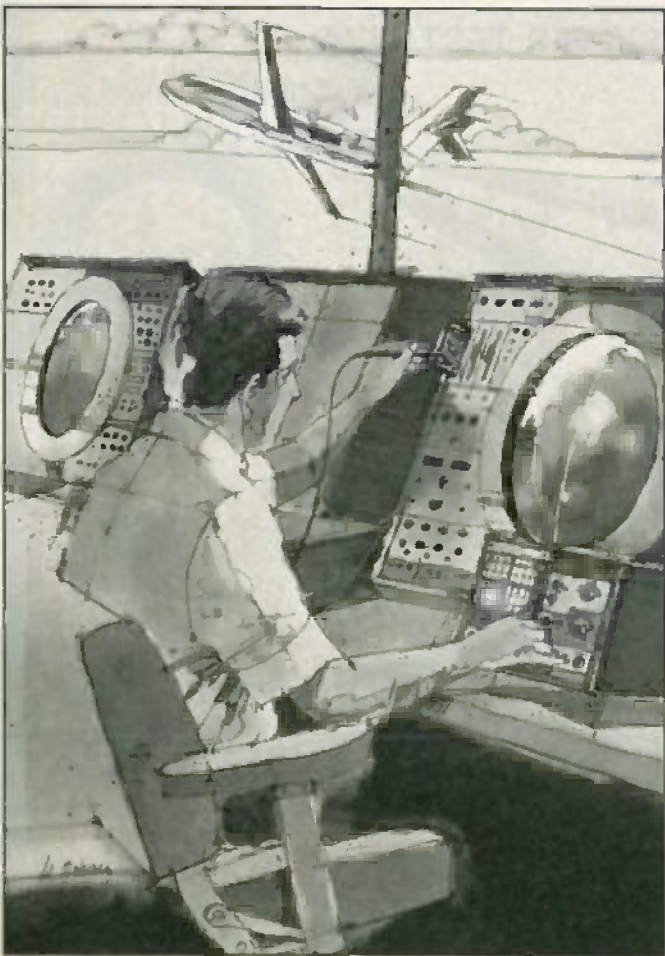
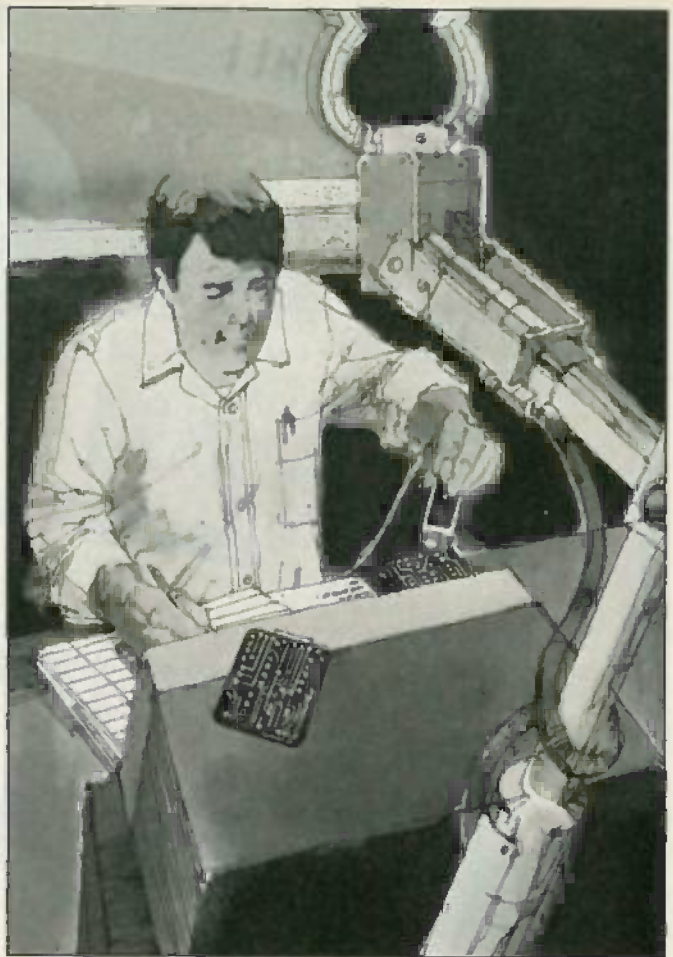

CIE MAKES THE WORLD OF ELECTRONICS YOURS.

Today's world is the world of electronics. To be part of it, you need the right kind of training, the kind you get from Cleveland Institute of Electronics, the kind that can take you to a fast growing career in business, aerospace, medicine, science, government, communications, and more.

Specialized training.

You learn best from a specialist, and that's CIE. We're the leader in teaching electronics through independent study, we teach only electronics and we've been doing it for over 50 years. You can put that experience to work for you just like more than 25,000 CIE students are currently doing all around the world.

Practical training.

You learn best with practical training, so CIE's Auto-Programmed® lessons are designed to take you step-by-step, principle-by-principle. You also get valuable hands-on experience at every stage with sophisticated electronics tools CIE-designed for teaching. Our 4K RAM Microprocessor Training Laboratory, for example, trains you to work with a broad range of computers in a way that working with a single, stock computer simply can't.

Personalized training.

You learn best with flexible training, so we let you choose from a broad range of courses. You start

with what you know, a little or a lot, and you go wherever you want, as far as you want. With CIE, you can even earn your Associate in Applied Science Degree in Electronics Engineering Technology. Of course, you set your own pace, and, if you ever have questions or problems, our instructors are only a toll-free phone call away.

The first step is yours.

To find out more, mail in the coupon below. Or, if you prefer, call toll-free 1-800-321-2155 (in Ohio, 1-800-523-9109). We'll send a copy of CIE's school catalog and a complete package of enrollment information. For your convenience, we'll try to have a representative contact you to answer your questions.

CIE Cleveland Institute of Electronics 1776 East 17th St., Cleveland, Ohio 44114

YES! I want to get started. Send me my CIE school catalog including details about the Associate Degree Program. I am most interested in:

- | | |
|--|---|
| <input type="checkbox"/> computer repair | <input type="checkbox"/> television/high fidelity service |
| <input type="checkbox"/> telecommunications | <input type="checkbox"/> medical electronics |
| <input type="checkbox"/> robotics/automation | <input type="checkbox"/> broadcast engineering |
| <input type="checkbox"/> other _____ | |

Print Name _____

Address _____ Apt. _____

City _____ State _____ Zip _____

Age _____ Area Code/Phone No. _____

Check box for G.I. Bulletin on Educational Benefits

- Veteran Active Duty

MAIL TODAY!

OR CALL TOLL FREE
1-800-321-2155
(In Ohio, 1-800-523-9109)

RE-38

JUNE 1986

19

EQUIPMENT REPORTS

VIZ WD-757 Frequency Counter

A sturdy and functional universal counter.



CIRCLE 5 ON FREE INFORMATION CARD

THE ON-GOING REVOLUTION IN DIGITAL electronics benefits not only consumer products like stereos, VCR's, and personal computers, but also the test instruments we use to keep those devices in top-notch condition. The VIZ WD-757

is one beneficiary of the LSI revolution; it is a capable, 1-GHz frequency counter available from VIZ Test Equipment, 335 East Price Street, Philadelphia, PA 19144. It is based on Intersil's ICM7226 LSI Frequency Counter IC.

External view

The WD-757 comes in a metal case that measures about $3\frac{3}{8} \times 8\frac{3}{4} \times 11$ (all dimensions in inches), and weighs about 3½ pounds. All circuitry is enclosed in an EMI-resistant metal cabinet. The instrument's front panel has three BNC input jacks, three input-select slide switches, two function-select rotary switches, a push-on/push-off power switch, and a momentary contact RESET switch. Its display consists of eight seven-segment LED's, and four discrete LED's. A rotatable metal handle allows you to prop the WD-757 at a comfortable viewing angle. The rear panel has a BNC connector for an external clock input, a

- Delayed Sweep
- 20MHZ, Dual Trace
- Component Tester
- Much More

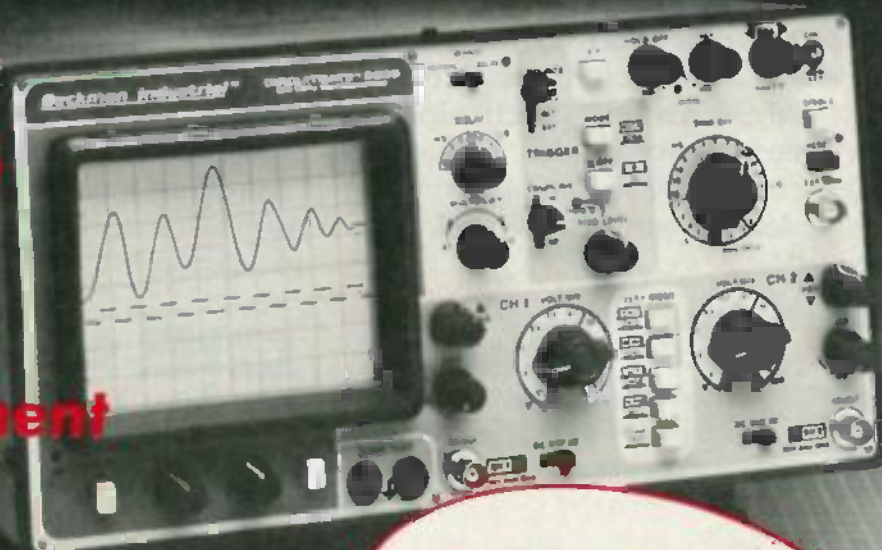

\$495

Beckman Industrial

Instrument Products Division • Beckman Industrial Corporation • A Subsidiary of Emerson Electric Company
830 Puente Street • Brea, California 92621 • (714) 871-4800 TWX: 910-992-1260 Telex: 487790

CIRCLE 98 ON FREE INFORMATION CARD

Heathkit®



A completely mobile, programmable, electromechanical robot, HERO® 2000 is capable of interacting with its environment free of external control.

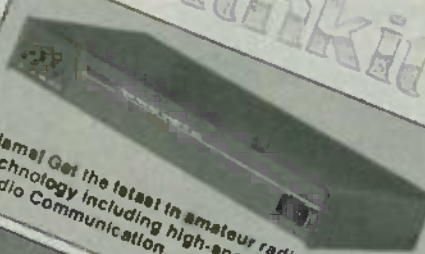

Home! Get the latest in amateur radio technology including high-speed Packet Radio Communication.



Powerful new IBM-PC compatible Heathkit computers are yours to build easily and save with, or to buy assembled.



Build from our full line of precision test instruments and see how they can increase your troubleshooting effectiveness.

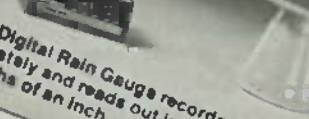

New Digital Rain Gauge records rainfall accurately and reads out inside your home in 100ths of an inch.

Your guide to everything that's new in electronics, computers and technical education. Over 400 items. Discover fascinating kits to build, enjoy and learn with, as well as assembled high tech products for home, business and hobby.

Get our famous High Tech Catalog

FREE

Heathkit®
Heath
Company

A subsidiary of Zenith Electronics Corporation
CIRCLE 86 ON FREE INFORMATION CARD

Heath Company
Dept. 020-424
Benton Harbor, Michigan 49022

MAIL COUPON TODAY and receive the latest issue of the Heathkit Catalog free of charge

Name _____

Address _____

City _____ State _____

CL-783DR3 Zip _____

Power to the Product!

Low cost B&K-PRECISION DC power supplies with high cost features

NEW



Model 1630 (3 amp) \$225
Model 1610 (1 amp) \$150

Now you can have the power you need, wherever you need it, at a surprisingly low cost.

These new B&K-PRECISION power sources each give you control up to 30 volts DC with fully adjustable current limiting. Other features include:

- Excellent regulation and low-ripple characteristics
- Dual meters monitor voltage and current simultaneously
- Two current ranges
- Fine and coarse voltage controls
- Isolated output
- Protected against reverse polarity external voltages
- Two identical supplies can be connected in series or parallel
- Can be used as a constant voltage or constant current source

Compare prices, features and performance, and you'll agree that the 1610 and 1630 power supplies are revolutionary.

Available for immediate delivery at your local B&K-PRECISION distributor. For additional information or the name of your local distributor contact B&K-PRECISION.



6460 West Cortland Street
Chicago, Illinois 60635 • 312/889-9087
International Sales, 6460 W. Cortland St., Chicago, IL 60635
Canadian Sales, Aztec Electronics, Ontario
South and Central American Sales,
Empire Exports, Plainville, NY 11803

switch to control the clock signal, and a fuse holder; the line cord also exits the rear panel.

Two of the front-panel BNC connectors provide the A and B inputs that are common on frequency counters built around Intersil's ICM7226 IC. The C input is for VHF/UHF inputs; it feeds the prescaler circuitry. A has an input impedance of 1 megohm and a sensitivity of 25 mv. The figures for B are 100K ohms and 20 mv; and, for C, 50 ohms and 50 mv.

Two of the slide switches allow you to choose the frequency range: under 10 MHz, under 100 MHz, or under 1 GHz. The third slide switch controls a 10:1 attenuator. The attenuator may only be used on the under-100 MHz ranges.

The rotary FUNCTION switch allows you to measure frequency and period, to count events, to measure the A:B frequency ratio, and to make time-interval measurements. To measure time interval, a start pulse is applied to the A input, and a stop pulse is applied to the B input. The display will then indicate the elapsed time.

The rotary RANGE switch allows you to control the resolution and accuracy of your frequency and period measurements. When measuring frequency, you can select a gate time of 10 seconds, or 1, 0.1, or 0.01 second. In the ten-second "range," for example, the WD-757 counts pulses for ten seconds and then divides by the appropriate factor for display. When measuring period, the WD-757 will make 1, 10, 100, or 1000 measurements and then calculate their average for display.

The discrete LED's light up to indicate: MHz or KHz when measuring frequency; μ s when measuring period; gating. The gate LED blinks each time a counting period has elapsed—every 10 seconds, or every 1, $\frac{1}{10}$, or $\frac{1}{100}$ second.

What's inside

The heart of the WD-757 is Intersil's ICM7226 *Universal Frequency Counter*, so, if you're familiar with that IC, the WD-757's variety of functions should also look familiar. Frequencies under 10 MHz are handled by the ICM7226 through a FET-input differential amplifier

VIZ	WD-757									
OVERALL PRICE	1	2	3	4	5	6	7	8	9	10
EASE OF USE	1	2	3	4	5	6	7	8	9	10
INSTRUCTION MANUAL	1	2	3	4	5	6	7	8	9	10
PRICE/VALUE	1	2	3	4	5	6	7	8	9	10
	1	2	3	4	5	6	7	8	9	10
	1	2	3	4	5	6	7	8	9	10

that is built from discrete components; frequencies from 10–100 MHz are first fed through a Schottky TTL decade divider; frequencies above 100 MHz are fed to a prescaler built around the MC5121, CA3199E, and MC12009L IC's.

Documentation

A 13-page manual is included with the WD-757; it includes basic instructions on how to operate the instrument, as well as complete technical information on the WD-757. Schematic diagrams, parts lists, PC-board patterns, and a section on theory of operation are all included. In addition, instructions on how to calibrate the WD-757 are included, should calibration become necessary. The manual is written in a somewhat stiff manner, and it contains a few typos, but all in all we'd like to see more manuals provide as much information as that one.

Impressions

In a sense, there's not much to say about the WD-757 other than that it does everything VIZ claims it can do. The switches and connectors all have a good solid feel, and we had no difficulty integrating the WD-757 with our odd assemblage of test instruments.

Our only complaint with the WD-757 is that, for \$525, a few things might have been included that would have made the WD-757 much more versatile and accurate. For example, a variable trigger-level control and an LED to indicate when triggering has occurred would be useful. In addition, the crystal timebase is *not* a proportional-oven type. Finally, no probes are included, and a good pair good low-capacitance probes could easily cost an additional \$100. R-E

Super DiskTM Diskettes

Now...Diskettes you can swear by, not swear at.

Lucky for you, the diskette buyer, there are many diskette brands to choose from. Some brands are good, some not as good, and some you wouldn't think of trusting with even one byte of your valuable data. Sadly, some manufacturers have put their profit motive ahead of creating quality products. This has resulted in an abundance of low quality but rather expensive diskettes in the marketplace.

A NEW COMPANY WAS NEEDED AND STARTED

Fortunately, other people in the diskette industry recognized that making ultra-high quality diskettes required the best and newest manufacturing equipment as well as the best people to operate this equipment. Since most manufacturers seemed satisfied to give you only the everyday quality now available, an assemblage of quality conscious individuals decided to start a new company to give you a new and better diskette. They called this product the *Super Disk* diskette, and you're going to love them. Now you have a product you can swear by, not swear at.

HOW THEY MADE THE BEST DISKETTES EVEN BETTER

The management of *Super Disk* diskettes then hired all the top brains in the diskette industry to make the *Super Disk* product. Then these top bananas (sometimes called floppy freaks) created a new standard of diskette quality and reliability. To learn the "manufacturing secrets" of the top diskette makers, they've also hired the remaining "magnetic media moguls" from competitors around the world. Then all these world class, top-dollar engineers, physicists, research scientists and production experts (if they've missed you, send in your resume to *Super Disk*) were given one directive...to pool all their manufacturing know-how and create a new, better diskette.

HOW SUPER DISK DISKETTES ARE MANUFACTURED

The *Super Disk* crew then assembled the newest, totally quality monitored, automated production line in the industry. Since the manufacturing equipment at *Super Disk* is new, it's easy for *Super Disk* to consistently make better diskettes. You can always be assured of ultra-tight tolerances and superb dependability when you use *Super Disk* diskettes. If all this manufacturing mumbo-jumbo doesn't impress you, we're sure that at least one of these other benefits from using *Super Disk* diskettes will:

- 1. TOTAL SURFACE TESTING** - For maximum reliability, and to lessen the likelihood of disk errors, all diskettes must be totally surface tested. At *Super Disk*, each diskette is 100% surface tested. *Super Disk* is so picky in their testing, they even test the tracks that are in between the regular tracks.
- 2. COMPLETE LINE OF PRODUCTS** - For a diskette to be useful to you and your computer, it must be compatible physically. *Super Disk* has an entire line of 5 1/4-inch and 3 1/2-inch diskettes for your computer.
- 3. SPECIALLY LUBRICATED DISK** - *Super Disk* uses a special oxide lubricant which is added to the base media in the production of their diskettes. This gives you a better disk drive head to media contact and longer head and disk life.
- 4. HIGH TEMPERATURE/LOW-MARRING JACKET** - A unique high temperature and low-marring vinyl jacket allows use of their product where other diskettes won't work. This special jacket is more rigid than other diskettes and helps eliminate dust on the jacket.
- 5. REINFORCED HUB RINGS** - Standard on all 48 TPI *Super Disk* mini-disks, to strengthen the center hub hole. This increases the life of the disk to save you money and increase overall diskette reliability.
- 6. DISK DURABILITY** - *Super Disk* diskettes will beat all industry standards for reliability since they will give you more than 75% of the original signal amplitude remaining even after an average (Weibull B-50) of 30 million passes. They are compatible with all industry specifications as established by ANSI, ECMA, ISO, IBM and JIS.
- 7. CUSTOMER ORIENTED PACKAGING** - All *Super Disk* disks are packaged 10 disks to a carton and 10 cartons to a case. The economy bulk pack is packaged 100 disks to a case without envelopes or labels.
- 8. LIFETIME WARRANTY** - If all else fails, remember, all disks made by *Super Disk* Inc. have a lifetime warranty. If any *Super Disk* diskette fails to meet factory specifications, *Super Disk* Inc. will replace them under the terms of the *Super Disk* warranty.
- 9. SUPERB VALUE** - With *Super Disk's* automated production line, high-quality, error-free disks are yours without the high cost.

Order toll free 800-USA-DISK

NOW... NAME BRAND QUALITY AT SUPER CE PRICES

Now, you can buy *Super Disk* brand diskettes directly from Communications Electronics at prices less than "unbranded" generic diskettes. Your data is valuable, so why take chances using a diskette that could be so unreliable that the manufacturer refuses to put their name on it. To save you even more, we also offer *Super Disk* bulk product where 100 diskettes are packed in the same box without envelopes or labels. Since we save packaging costs, these savings are passed on to you. 5 1/4" diskette envelopes are also available from us. These *Super Disk* strong and tear resistant envelopes are only \$10.00 per pack of 100. Use order # CV-5 for a 100 pack of 5 1/4" diskette envelopes.

39¢ per disk Quantity One

Our diskettes are packed 10 disks to a carton and 10 cartons to a case. The economy bulk pack is packaged 100 disks to a case without envelopes or labels. For best value, you should order in increments of 100 diskettes. Almost all diskettes are immediately available from *Super Disk*. With our efficient warehouse facilities, your order is normally shipped in less than a day.

SAVE ON SUPER DISK TM DISKETTES	Part #	Super Disk Price per disc (\$)
Product Description		
5 1/4" SSSD Soft Sector w/Hub Ring	6431-FA	0.84
5 1/4" Same as above, but bulk pack w/o envelope	6437-FA	0.39
5 1/4" SSDD Soft Sector w/Hub Ring	6481-FA	0.68
5 1/4" Same as above, but bulk pack w/o envelope	6487-FA	0.43
5 1/4" DSDD Soft Sector w/Hub Ring	6491-FA	0.74
5 1/4" Same as above, but bulk pack w/o envelope	6497-FA	0.49
5 1/4" DSQD Soft Sector (96 TPI)	6501-FA	1.09
5 1/4" Same as above, but bulk pack w/o envelope	6507-FA	0.84
5 1/4" DSHD for IBM PC/AT - bulk pack	6667-FA	2.07
3 1/2" SSDD (135 TPI) - bulk pack	6317-FA	1.67
3 1/2" DSDD (135 TPI) - bulk pack	6327-FA	1.99

SSSD = Single Sided Single Density; SSDD = Single Sided Double Density; DSDD = Double Sided Double Density; DSQD = Double Sided Quad Density; DSHD = Double Sided High Density; TPI = Tracks per inch.

BUY YOUR DISKETTES FROM CE WITH CONFIDENCE

To get the fastest delivery of your diskettes, phone your order directly to our order desk and charge it to your credit card. Written purchase orders are accepted from approved government agencies and most well rated firms at a 10% surcharge for net 10 billing. For maximum savings, your order should be PrePaid. All sales are subject to availability, acceptance and verification. All sales are final. All prices are in U.S. dollars. Prices, terms and specifications are subject to change without notice. Out of stock items may be placed on backorder or substituted for equivalent product unless we are instructed differently. A \$5.00 additional handling fee will be charged for all orders with a merchandise total under \$50.00. All shipments are F.O.B. CE warehouse in Ann Arbor, Michigan. No COD's. Non-certified checks require bank clearance. Michigan residents add 4% sales tax or supply your tax ID number and reason for tax exemption.

For shipping charges add \$6.00 per 100 diskettes and/or any fraction of 100 5 1/4-inch or 3 1/2-inch diskettes for U.P.S. ground shipping and handling in the continental U.S. For 1,000 or more disks shipped to the continental U.S., shipping charges are \$4.00 per hundred diskettes. UPS 2nd day air rates are three times continental U.S. rates. For Canada, Puerto Rico, Hawaii, Alaska, or APO/FPO delivery, shipping is three times the continental U.S. rate.

Mail orders to: Communications Electronics Inc., Box 1045, Ann Arbor, Michigan 48106-1045 U.S.A. If you have a Visa or Master Card, you may call and place a credit card order. Order toll-free in the U.S. Dial 800-USA-DISK. In Canada, order toll-free by calling 800-CA1-DISK. If you are outside the U.S. or in Michigan dial 313-973-8888. Telex anytime 810-223-2422. Order your *Super Disk* diskettes now.

Copyright © 1986 Communications Electronics Inc.

Ad #040186-FA



**Now
39¢
a disk**

JUNE 1986

CIRCLE 194 ON FREE INFORMATION CARD

23

ATTENTION! ELECTRONICS TECHNICIANS

EARN YOUR
**B.S.E.E.
DEGREE**
THROUGH HOME STUDY



Our New and Highly Effective Advanced-Placement Program for experienced Electronic Technicians grants credit for previous Schooling and Professional Experience, and can greatly reduce the time required to complete Program and reach graduation. No residence schooling required for qualified Electronic Technicians. Through this Special Program you can pull all of the loose ends of your electronics background together and earn your B.S.E.E. Degree. Upgrade your status and pay to the Engineering Level. Advance Rapidly! Many finish in 12 months or less. Students and graduates in all 50 States and throughout the World. Established Over 40 Years! Write for free Descriptive Literature.

COOK'S INSTITUTE
OF ELECTRONICS ENGINEERING

CE 347 RAYMOND ROAD
P.O. BOX 20345
JACKSON, MISSISSIPPI 39209

CIRCLE 190 ON FREE INFORMATION CARD

Mirage-KLM JV-2X VHF Antenna

A low-cost, high-
performance VHF antenna



CIRCLE 6 ON FREE INFORMATION CARD

HOW MANY TIMES HAVE YOU LISTENED to a scanner or other radio, only to hear an interesting radio transmis-

sion fade out just when it was getting meaty? If you're like us, it's probably happened to you more than once.

The answer to that problem might be as simple as putting up an outdoor antenna, such as one we recently tried, the JV-2X from Mirage-KLM (16890 Church St., Morgan Hill, CA 95037).

If you're relying on an indoor antenna now, just about any outdoor antenna will improve your reception. But if you have an outdoor antenna now and still are not getting the performance you need from your VHF rig, then it's important to remember that in the world of antennas everything isn't created equal.

For instance, a $\frac{1}{2}$ -wave antenna will show about 3 dB of gain over a $\frac{1}{4}$ -wave antenna, and a longer antenna can show an even greater gain improvement. The JV-2X is an extended J-pole antenna that is roughly two wavelengths long (about 12 feet) at 144 MHz. That is extremely long compared to the majority of VHF antennas that we have seen, but the size is the key to

WAVETEK

Our 2 MHz Function Generator has an unlimited range.

Model 20 not only covers the .002 Hz to 2.1 MHz frequency range, it covers the world. With internal NiCad batteries,* you can take Model 20 anywhere and get triggered, gated or continuous waveforms—sines, squares, and triangles up to 20 volts peak to peak. It recharges from wall transformer (included) or external source from 12 to 25 VDC or 10 to 18 VAC. Model 20 also has many of the features you would expect from the industry leader in function generators, including VCG input connector for external sweep or FM, step attenuator to -80dB, and a TTL pulse output. The price is just \$395. For a data sheet or to order, call or write Wavetek San Diego, P.O. Box 85265, 9045 Balboa Ave., San Diego, CA 92138. Phone (619) 279-2200; TWX (910) 335-2007. *Batteries not included



CIRCLE 185 ON FREE INFORMATION CARD

ELENCO PRODUCTS AT DISCOUNT PRICES!

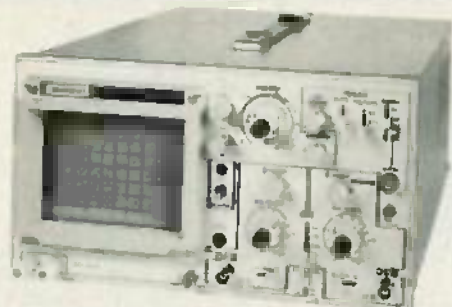

20 MHz DUAL TRACE OSCILLOSCOPE
\$329 MO-1251

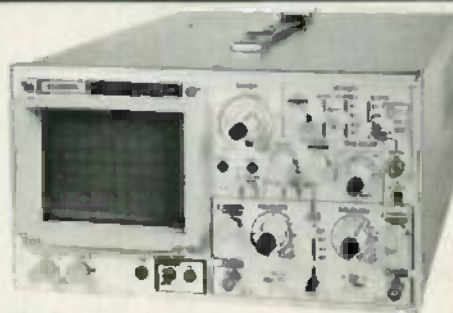

35 MHz DUAL TRACE OSCILLOSCOPE
\$545 MO-1252

Top quality scopes at a very reasonable price. Contains all the desirable features. Elenco's 2 year guarantee assures you of continuous service. Two 1x, 10x probes, diagrams and manual included. Write for specifications.



MULTI METER with CAPACITANCE and transistor tester

\$65 Model CM-1500

Reads Volts, Ohms, Current, Capacitors Transistors & Diodes



TRUE RMS 4 1/2 DIGIT MULTIMETER

\$135 Model M-7000

.05% DC Accuracy
 .1 % Resistance with Freq. Counter & Deluxe Case



3 1/2 DIGIT MULTIMETER

\$25 Model M-1600

1% DC Accuracy
 1% Resistance
 Reads 10A DC

GF-8016 Function Generator with Freq. Counter

\$219

- Sine, Square, Triangle,
- Pulse, Ramp, .2 to 2 MHz
- Frequency .1 thru 10 MHz

GF 8015 without Freq. Meter \$169

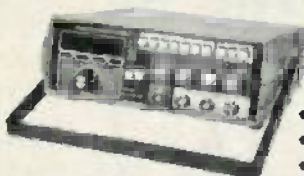

NEW

POWER BLOX

The Power Supply For Breadboarding



\$1495

\$995

Now a Power Supply for your Bread Blocks. Snaps in to existing units. Fully regulated and short circuit protected.

12V @ .3A, 5V @ 1A, -5V @ .5A

\$22.95 for Both, Power Blox & Breadboard

Triple Power Supply XP-660

\$14950

0-20V @ 1A
 0-20V @ 1A
 5V @ 5A

Fully Regulated, Short Circuit Protected with 2 Limit Cont. 3 Separate Supplies.

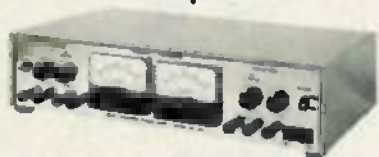

3 Amp Power Supply XP-650

\$11950

0-40V @ 1.5A
 0-20V @ 3A

Fully regulated, short circuit protected current limit control



DIGITAL LCR METER

Model LC-1800
 Measures: Inductors
 Capacitors, Resistors

\$148

Inductors .1μH to 200 H
 Capacitor .1Pf to 200μf
 Resistor .01Ω to 20M Ω
 Ranges 6 Ind, 7 cap, 7 res

C&S SALES, 8744 W. North Ter. Niles, IL 60648
 800-292-7711 (312) 459-9040



15 DAY MONEY BACK GUARANTEE ASK FOR CATALOG

2 Year Limited Guarantee! Add 5% for Postage (\$10 max.), IL Res., 7% Tax

CIRCLE 109 ON FREE INFORMATION CARD

JUNE 1986

25

Radio-Electronics mini-ADS

Mirage-KLM		JV-2X												
OVERALL PRICE														
EASE OF USE														
INSTRUCTION MANUAL														
PRICE/VALUE														
		1	2	3	4	5	6	7	8	9	10			
		Poor		Fair		Good		Excellent						

the unit's superior performance. In our tests we found about a 6-dB increase in received signal strength over a ¼-wave antenna. That's about all the gain you'd need for a scanning radio. For transmitting applications, similar gain figures are obtainable.

Set-up and use

Our first impression after pulling the unit out of the box was that assembly would be a formidable task. That was due to the large number of pieces involved, and a set of instructions that were vaguely written and confusing. (According to the company, the instructions have since been revised.) What saved the day was the fact that those instructions were accompanied by some very clear illustrations. Following those, assembly was not difficult at all. The entire operation went smoothly and took less than an hour. Using the antenna lengths suggested in the instructions, the unit tuned up easily.

Once the antenna is set up there's little else to do except connect the coaxial cable and use it.

Overall, the JV-2X is a worthy successor to the JV-2, which is a shorter version of the same antenna. With a suggested list price of \$39.95, it's a bargain, too! R-E



THE WIRELESS TELEPHONE TRANSMITTER model WTT-20 is only the size of a dime, yet transmits both sides of a telephone conversation with crystal clarity. Completely automatic. Uses power from the telephone line itself. Never needs a battery! Up to ¼ mile range. Use with any FM radio. Complete kit only \$29.95. Tax included. VISA and MasterCard accepted. **FREE SHIPPING. DECO INDUSTRIES, Box 607, Bedford Hills, NY 10507. (914) 241-2827.**

CIRCLE 127 ON FREE INFORMATION CARD



SATELLITE DESCRAMBLER MANUAL Now introducing complete technical information for the **M/A-COM VIDEO CIPHER 2 DESCRAMBLER, USED BY HBO, CINEMAX AND OTHER PAY T.V. SERVICES.** 34 page book contains Schematics, Circuit Drawings, Parts Lists and Theory of Operation, for both the VIDEO and AUDIO CIRCUITS. **OTHER DESCRAMBLER CIRCUITS AVAILABLE.** \$23.95, first class postage included. ADD \$2.00 for C.O.O. **NORSAT COMMUNICATIONS, 11700 MERRIMAN ROAD, LIVONIA, MICH. 48150 (313)965-5544.**

CIRCLE 195 ON FREE INFORMATION CARD



MTS STEREO ADAPTER. Add the dramatic, new dimension of MTS STEREO to virtually any TV or VCR using the Audio Output Plug and your stereo system. So versatile it even simulates extra ordinary stereo sound on non-stereo broadcast. Assembled \$81.00, also available in kit form, \$52.00. N.Y. Residence add tax. **DEL-PHONE INDUSTRIES, Box 150, Elmont, New York 11003.**

CIRCLE 186 ON FREE INFORMATION CARD

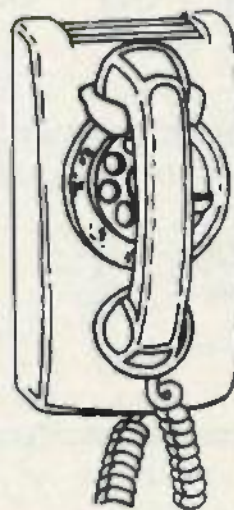

CALL NOW AND RESERVE YOUR SPACE

- 6 x rate \$745.00 per each insertion.
- Reaches 229,044 readers.
- Fast reader service cycle.
- Short lead time for the placement of ads.
- We typeset and layout the ad at no additional charge.

Call **516-293-3000** to reserve space. Ask for Arline Fishman. Limited number of pages available. Mail materials to: mini-ADS, RADIO-ELECTRONICS, 500-B BI-County Blvd., Farmingdale, NY 11735.

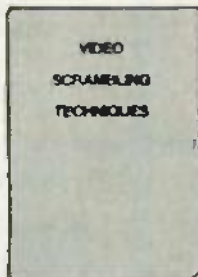

SUBSCRIPTION TV MANUAL. This information packed book details the methods used by subscription TV companies to scramble and descramble video signals. Covers the Sinewave, Gated Pulse, SSAVI system, and the methods used by most cable companies. Includes circuit schematics, theory, and trouble shooting hints. **Only \$12.95 plus \$2.00 first class P&H. ELEPHANT ELECTRONICS, INC., Box 41865-R, Phoenix, AZ 85080**

CIRCLE 120 ON FREE INFORMATION CARD

Imagine

running 26 miles just for fun

USO's sports events are one way that servicemen and women can spend their off duty times. In fact, it's also a way to meet other people and to feel a part of things when far from home. "Because life's toughest battles aren't always fought in the field."

Support USO through the United Way, OCF, or local USO campaign.

Radio-Electronics mini-ADS



NEW PUBLICATION, "5 Great Ways to Use the SSAVI": a complete guide for all uses, including conversion to a stereo TV decoder \$6.50 ppd. ZENITH SSAVI Descramblers only \$169. Gated pulse \$199. Reconditioned original equipment for UHF chs. 27, 48, 41 & 60, etc. Quantity discounts. Surplus TV equipment: Oak N-12, Hamlin MLD-1200, SB-3, etc. Warranty. Catalog \$1. AIS SATELLITE, P.O. Box 1226-A, Dublin, PA, 18917. 215-249-9411.

CIRCLE 81 ON FREE INFORMATION CARD



R&D SHEET METAL WORKER—New multi-purpose Shear, Brake and Roll now with 6" male dies, removable and removable female dies. A complete in-house shop at 1/3rd the cost. Over 20 years development/sales worldwide in industry, government and education. Free literature or \$2.00 for "Guide to Sheet Metal Working." **PACIFIC ONE CORPORATION**, 513 Superior Ave., Suite 54, Newport Beach, CA 92663 (714) 645-5962 Telex 4996168.

CIRCLE 118 ON FREE INFORMATION CARD



SAY GOOD-BYE TO BORING ONE-DIMENSIONAL TV SOUND. Say hello to dynamic MTS (Multichannel Television Sound) MTS is the only FCC approved method of broadcasting all the new stereo TV programs into your home with cinema-like quality. Recoton V622 \$129.95 & 6.50 S & H. Visa/MasterCard 1 (800) 522-2636 Order only, (617) 871-5611 for information. **CAMEO ENTERPRISES INC.**, 45 Accord Pk., Norwell, MA 02061.

CIRCLE 89 ON FREE INFORMATION CARD

CALL NOW AND RESERVE YOUR SPACE

- 6 x rate \$745.00 per each insertion.
- Reaches 229,044 readers.
- Fast reader service cycle.
- Short lead time for the placement of ads.
- We typeset and layout the ad at no additional charge.

Call 516-293-3000 to reserve space. Ask for Arline Fishman. Limited number of pages available. Mail materials to: mini-ADS, RADIO-ELECTRONICS, 500-B Bi-County Blvd., Farmingdale, NY 11735.



MICROWAVE ANTENNAS \$69.95 + shipping, lifetime warranty. We repair all types of downconverters. Satellite Dishes and parts complete 9' dish with block system, 80° LNA by arcfinder \$995.00. Coax cable T.V. parts, accessories connectors, T.V. amplifiers. Write for free catalog or call for prices. **BLUE STAR IND.**, Dept. RE6-86, 4712 Ave. N, Brooklyn, N.Y. 11234 (718) 338-8318 Ext. 105.

CIRCLE 85 ON FREE INFORMATION CARD

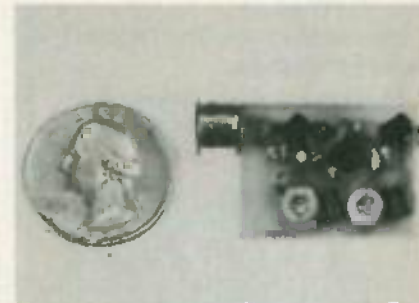

THE MOST EXCITING KIT YOU WILL EVER BUILD The model WAT-50 miniature FM transmitter uses a 4-stage circuit NOT to be confused with a simple wireless microphone. Up to 1 mile range. So sensitive, it will pick-up a whisper 50 feet away! Use with any FM radio. Complete kit only \$29.95 tax incl. VISA and MasterCard accepted. **FREE SHIPPING** DECO INDUSTRIES, Box 607, Bedford Hills, NY 10507. (914) 241-2827.

CIRCLE 127 ON FREE INFORMATION CARD



SINGLE AND DUAL TRACE Scopes, Analog and Digital Multimeters, Power Supplies, High Voltage and Low Cap. Probes, RF and Sine/Square Wave Generators, Digital Capacity Meters. Available at your local distributor **EMCO ELECTRONICS**, P.O. Box 327, Plainview, NY 11803. Send for your free catalog.

CIRCLE 188 ON FREE INFORMATION CARD



TV STEREO-SAP-ADAPTER: only \$79.00 to modify your existing TV set as a Stereo-Second Audio Program-Function TV. It requires single line from TV and stereo amplifier. Detail instruction manual for modification is included. Allow 4-6 weeks delivery. **INTEK ELECTRONICS**, P.O. BOX 76417, Los Angeles, CA 90076, (213) 739-1664.

CIRCLE 179 ON FREE INFORMATION CARD



LOW COST PROBES. • Replacements for all makes of probes • Fit all makes of oscilloscopes • Save up to one-half on cost • Performance guaranteed • Send for free catalog • For immediate service call: 800-368-5719 outside Calif. 800-643-8382 in Calif. **TEST PROBES, INC.** P.O. Box 2113, La Jolla, California 92038.

CIRCLE 123 ON FREE INFORMATION CARD

Capacitance, logic and more. For less.

Now, a fully-loaded DMM combines a capacitance meter, logic probe, and an hFE meter, all for the price of a DMM.

TTL Logic Probe: 20 MHz

Hi/lo/off indications

Detects 25nS pulse width

Capacitance: 5 ranges (2nF to 20 μ F)

hFE (NPN or PNP): 1 range (1000)

DMM: DCV-5 ranges (.2V to 1kV)

ACV-5 ranges (.2V to 750V)

DCA-4 ranges (200 μ A to 10A)

ACA-3 ranges (20mA to 10A)

Ohms-7 ranges (200 Ohms to 2000 Megohms)

Continuity beeper

Diode check

Built-in bail

Anti-skid pads

See one now at your local Beckman Industrial distributor.

DM25L... \$89⁹⁵*

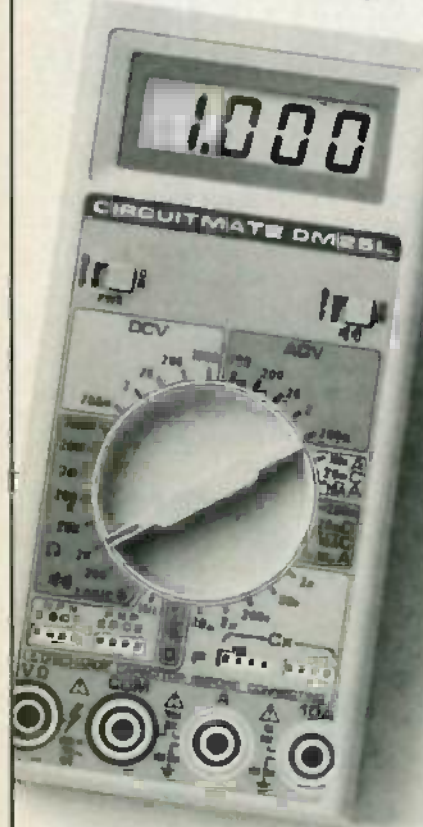

*Suggested list price (\$US) with battery, test leads and manual

Beckman Industrial™

Beckman Industrial Corporation
A Subsidiary of Emerson Electric Company
630 Puente Street, Brea, CA 92621
(714) 671-4800

© Copyright 1985 Beckman Industrial Corporation

NEW PRODUCTS

LAMP TIMERS, models *ST1B* and *ST2B*, feature random-setting control to vary the time that the lamps turn on and off. (If lights turn on and off at the same time each day, burglars might not be fooled.) The timers' built-in photocell automatically detects when it is time to turn a lamp on for up to 10 hours. To vary the time lights turn on and off, the user merely activates the "random setting" control. No seasonal adjustments are necessary to ensure that the light turns on at the right time, and the timer



CIRCLE 21 ON FREE INFORMATION CARD

doesn't have to be reset after a power failure.

The tabletop model *ST2B* is used when wall outlets are hidden by curtains or furniture. It features a smoke-tinted lid, dimmer, and a six-foot power cord, and is designed for incandescent light-bulbs up to 500 watts. It has a suggested retail price of \$21.95.

The model *ST1B* is used when wall outlets are exposed to natural daylight. It plugs directly into any standard 125-volt outlet, and is designed for incandescent light-bulbs up to 300 watts. The suggested retail price is \$17.95. Both timers are UL-listed.—Intermatic Inc., Intermatic Plaza, Spring Grove, IL 60081.

LOW COST, RELIABLE, HIGH PERFORMANCE DIGITAL MULTIMETERS



MIC-6E 3½ Digit DMM \$34.95
¼% accuracy, DCV, DCA, ACV, ACA, beeper, diode test and temperature

MIC-LCR Meter \$99.95
3½ digit, 1% accuracy, capacitance, conductance, resistance

MIC-7000FA 4½ Digit DMM \$119.95
0.05% accuracy, freq. counter, DCV, DCA, ACV, ACA, beeper, over load protection, "Lo battery"

MIC-7000FT 4½ Digit DMM \$139.95
Same as 7000 FA plus TRUE RMS Measurement

We accept check & money order for **FREE** shipping, 1 year warranty. CA residents add 6% tax. Quantity discount.

YMK ENTERPRISES, INC. TDPOL PRODUCTS
14252 Culver Dr. P.O. Box 391703
Irvine, CA 92714 Mt. View, CA 94039
Ste. A-351 (408) 262-7441
(714) 551-9311

CIRCLE 191 ON FREE INFORMATION CARD

STEREO PREAMPLIFIER, model *DX300*, in addition to two tape monitors and tape-dubbing capability, features signal-processing capability for insertion of any signal processor into the signal path.



CIRCLE 22 ON FREE INFORMATION CARD

Video/audio inputs enable simple hook-up of a VCR's or video disc player's audio tracks to take full advantage of enhancements available when tapes are played

CIRCLE 176 ON FREE INFORMATION CARD

Two of the best HAMEG-Performers

2 year warranty

high quality at low cost

HM 205 an outstanding new Oscilloscope with Digital Storage

Realtime:

2 channels DC – 20 MHz
max. sensitivity 2mV/div.
Timebase 0.2 s – 20ns/div.
Trigger: DC – 35MHz (0.5 div.)
Built-in Component Tester
1kHz / 1 MHz calibrator (3 ns)
TV sync. separator

Digital Storage:

max. sampling rate 100kHz
Refresh-, Single-Mode
Storage: 8 bit x 2048 points
Timebase: 5 s – 0.1 ms/div.

CRT 8x10cm, int. graticule, 2kV

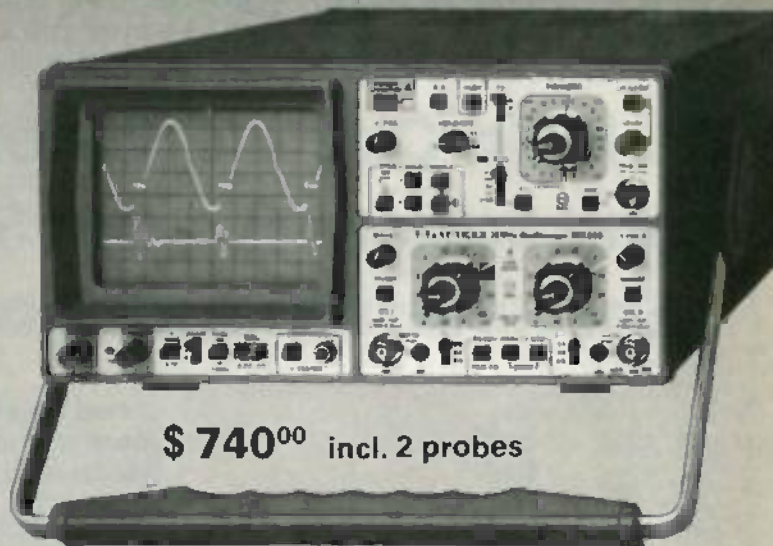

\$ 740⁰⁰ incl. 2 probes

HM 208 the high tech Digital Storage Scope with 20 MHz sampling rate

Realtime:

2 channels DC – 20 MHz
max. sensitivity 1mV/div.
Timebase 0.1 s – 20ns/div.
Trigger: DC – 40MHz (0.5 div.)

Digital Storage:

max. sampling rate 20 MHz
Roll-, Refresh-, Single-, XY-Mode
Storage: 8 bit x 4096 points
Timebase: 50 s – 1 μs/div.
Pretrigger: 0-25-50-75-100%

CRT 8x10cm, int. graticule, 14kV
IEEE-488 Interface Option



\$ 2390⁰⁰ incl. 2 probes

Write or call

HAMEG[®] Inc.

14 day full money back guarantee

88-90 Harbor Road · Port Washington, N.Y. 11050 · ☎ (516) 883.3837 · TWX (510) 223.0889

CIRCLE 62 ON FREE INFORMATION CARD

through a component stereo system. Compact disc inputs are designed to match the high dynamic-range capabilities of CD's.

With bass and treble controls, as well as a signal-processing loop, this new control center is adaptable to all existing stereo-component systems, as well as to new stereo VCR's and video systems. The model *DX3000* is priced at \$299.00.—Soundcraftsmen, 2200 South Ritchey, Santa Ana, CA 92705.

SOUND-EXPERIMENTER KIT, the model *JE755*, generates white noise, tones, and low-frequency sounds independently or in combination. It uses the Texas Instruments complex sound-generator IC, the 76477, to provide unlimited sound-generation capabilities.

The model *JE755* may be expanded with external parts; for example, an external amplifier or stereo system may be added to provide richer sound. The kit comes complete with compo-

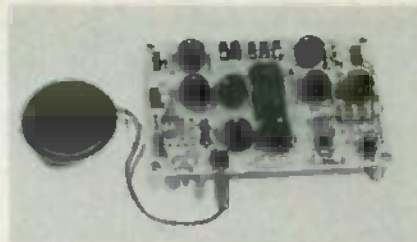

CIRCLE 23 ON FREE INFORMATION CARD

nents and instructions for assembly. The overall size of the model *JE755* is 5½" x 3¾" x 1¼". Suggested retail price is \$34.95.—Jameco Electronics, 1355 Shoreway Road, Belmont, CA 94002.

Build Circuits Faster and Easier With Our \$20 Solderless Breadboard



...and do even more with our \$40 breadboard

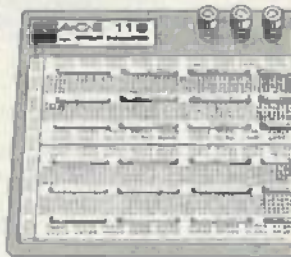

Introducing the plug-in world of AP Products' versatile, low cost breadboards.

Now you can design, build and test prototype circuits just like the professionals ... and make changes in seconds. No messy soldering or desoldering. No more twisted leads or damaged devices.

With our *ACE 109* and *118* blue breadboards, you simply plug in components and interconnect them with ordinary hook-up wire. All sizes of DIPs and other discrete components up to 22 gauge lead diameters snap right into the 0.1" x 0.1" matrix of the solderless tie points ... anywhere on the layout. You don't need expensive sockets or special tools. Buses of spring clip terminals form a distribution network for power, ground and clock lines.

AP Products' 100 series breadboards give you all the functions and flexibility of more expensive circuit evaluators. The spring terminals have mechanically independent contact fingers to accom-

modate most DIPs and discrete components (see diagram).

The *ACE 109* has two terminals for separate voltages plus a ground connection. The larger *ACE 118* offers the same three terminals, plus an additional terminal which can be used for clocking or another voltage. The backplates are heavy steel to keep the boards stationary.

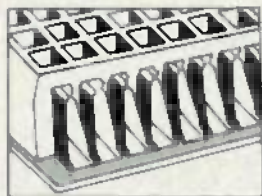

Don't wait. These low prices won't last forever. See your local AP Products dealer today, or send for a list of dealers in your area. Free information on request.

AP PRODUCTS/3M
9325 Progress Parkway
P.O. Box 540
Mentor, Ohio 44060
800-321-9668
(Ohio, 216/354-2101)

CIRCLE 76 ON FREE INFORMATION CARD

INTERFERENCE FILTER, model *5111*, tunes the entire 910-1440 MHz band to handle two common downconverter bands to suppress microwave telephone carriers. Channel interference is suppressed by tuning the single-turn dial to "notch out" the interfering carrier. The single-turn knob tunes a narrow 15-dB notch through the

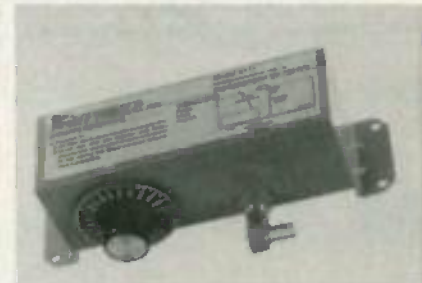

CIRCLE 24 ON FREE INFORMATION CARD

entire standard block-downconverter band. The 2" x 2" x 7¾" case has type F connectors, adhesive mounting feet, and operating instructions on an etched label.

Suggested retail price of the model *5111* is \$295.00.—Microwave Filter Company, Inc., 6743 Kinne St., East Syracuse, NY 13057.

ANTI-GLARE SPRAY, *Telefix*, is an aerosol spray that creates a non-reflective surface by coating the



CIRCLE 25 ON FREE INFORMATION CARD

glass with a crystalline film. It is particularly effective in brightly lit rooms where the picture can be washed out by reflected light.

Color and black-and-white sets of any size and shape can be sprayed. The *Telefix* film has a smooth spectral transmission curve that does not change the color that the viewer sees. One can cover up to eight TV screens. The price is \$20.00 per can.—**Telefix, U. S. A., 140 Bradley Drive, Santa Cruz, CA 95060.**

TVRO NOISE FILTER, the model 3278(2), is one of a series of band-pass filters that reduce background noise and are available for TVRO receivers with final IF frequencies in the UHF range of 385–700 MHz.



CIRCLE 26 ON FREE INFORMATION CARD

The typical 3-dB bandwidth is 14 MHz to produce clearer pictures in low-signal situations (due to small-dish use, partial dish blockage, or weak transponders, etc.). The filter will also suppress "sparklies" due to mild downconverted terrestrial interference.

Connectors are F-type. Center frequency is factory-tuned at prescribed IF but is field-tunable to compensate for receiver local-oscillator error, if any.

The model 3278(2) is priced at \$132.00.—**Microwave Filter Company, Inc., 6743 Kinne Street, East Syracuse, NY 13057.**

VARIABLE SPEED CD PLAYER, the model CD9000 is designed for the serious musician who wants the fidelity of a compact-disc player and the flexibility of variable pitch and speed control, for altering the



CIRCLE 27 ON FREE INFORMATION CARD

tonality and-tempo of musical selections.

In addition to variable speeds and pitch of $\pm 10\%$, the model

CD9000 features slide-in CD carriers to facilitate disc handling. There is a special program indicator, memory, playback, forward and reverse search modes, and a start/stop control. A remote control with all those functions is included.

The model CD9000 is housed in an EIA standard rack-mount chassis and it has a suggested list price of \$1669.00.—**Numark Electronics Corp., 503 Raritan Center, P.O. Box 493, Edison, NJ 08818. R-E**

Troubleshooting and Repair Guides for Today's Electronics Hobbyist.

Microcomputer Troubleshooting and Repair Guides

These easy-to-understand repair and maintenance guides provide the instructions you need to solve problems unique to your computer. The books contain schematic diagrams, block diagrams, photographs and troubleshooting flowcharts to trace the probable cause of failure. A final chapter on advanced troubleshooting shows you how to perform more complicated repairs.

Apple II + IIIe, No. 2235A, \$19.95
IBM PC, No. 2235B, \$19.95
Commodore 64, No. 2236A, \$19.95
Commodore 1541 Disk Drive, No. 2247D, \$19.95

John D. Lenk's Troubleshooting and Repair of Microprocessor-Based Equipment

John D. Lenk

Here are general procedures, techniques, and tips for troubleshooting equipment containing microprocessors from one of the foremost authors on electronics and troubleshooting. In this general reference title, Lenk offers a basic approach to troubleshooting that is replete with concrete examples related to specific equipment. Including VCRs and compact disk players, he highlights test equipment and pays special attention to common problems encountered when troubleshooting microprocessor-based equipment. No. 2247G, \$21.95

Microwave Oven Troubleshooting and Repair Guide

Jay R. Laws

This complete but elementary guide leads you through the electronics and basic steps of troubleshooting for this popular consumer product. It features a detailed description of the major components of a microwave, how the components operate, and the common problems that can occur. It includes a useful section on preventive maintenance and cleaning. The more experienced technician will appreciate the section on advanced repairs and adjustments. For easy reference, a special appendix listing manufacturers and parts is included. No. 2248I, \$19.95

The Home Satellite TV Installation and Troubleshooting Manual

Wynita and Gale

For the hobbyist or electronics buff, this title provides a comprehensive introduction to satellite communication theory, component operation, and the installation and troubleshooting of satellite systems. In a chapter sure to be much appreciated by anyone interested in this hot communications medium, the authors detail the why's and wherefore's of selecting satellite equipment. If you are among the 100,000 people per month who are installing a satellite, you'll want to have this book in your reference library. No. 2249E, \$29.95

Troubleshooting with the Oscilloscope and Digital Computer (5th Edition)

Robert G. Middleton

Troubleshooting with an oscilloscope is widely accepted as the most reliable method for analyzing malfunctions in electronic circuits. In this new edition, modern troubleshooting techniques are stressed, including the troubleshooting of digital-based equipment. Another key feature of the revision is the emphasis on the "what, why, and how to" of the time-domain analyzer, the data-domain analyzer, and the logic-state analyzer. No. 2247S, \$16.95

Send \$1.00 for Sams book catalog (product No. 985-009) with 400 titles covering electronics, computers, engineering, robotics and communications.



To order call
800-428-SAMS
In Indiana
call 317-298-5566
Ask For Operator 817

SAMS

A Division of Macmillan, Inc.

Book No.	Quantity	Price
Shipping & Handling		\$ 2.50
All CA, FL, IL, IN, NC, NY, OH, TN, WV residents add local sales tax		\$
Total		\$
Name _____		
Company _____		
Address _____		
City _____		
State _____ Zip _____		
Daytime Telephone No. _____		
<input type="checkbox"/> Bill my credit card <input type="checkbox"/> VISA <input type="checkbox"/> MC <input type="checkbox"/> A/E		
Account No. _____ Exp. Date _____		
Signature (required) _____		
<input type="checkbox"/> Check or money order enclosed. Make checks payable to Howard W. Sams & Co. Mail this form with payment to: Howard W. Sams & Co., Inc., Dept. DM • 4300 Will 62nd Street • Indianapolis, IN 46226		

DM 017

Prices subject to change without notice

NEW IDEAS

Telephone-answering system

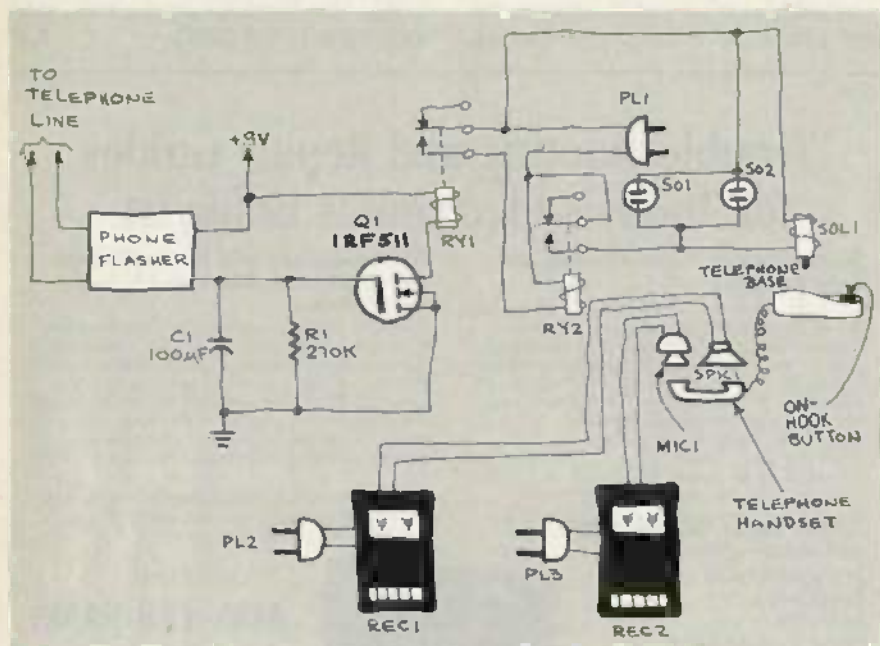

FIG. 1

IN ORDER TO AVOID MISSING IMPORTANT phone calls, many have gone out and gladly borne the expense of purchasing telephone-answering machines. Such units can range in cost from under a hundred dollars to more than a couple of hundred dollars. But, there is a way to avoid missing calls (without that expense), and have fun building the system yourself. The only real requirement is that you have two tape-recording machines.

How it works

The basis of the scheme shown in Fig. 1 is the *Fone Flasher* (available from Radio-Shack, catalog number 43-177), which is normally used to flash a light when the phone rings. That unit has an internal relay that, upon receiving a ring signal, closes, outputting a signal to a timing circuit.

The signal output by the *Fone Flasher* causes C1 to begin charging. When C1 is charged, a voltage

is applied to the gate of transistor Q1, turning it on. That provides a ground path for RY1, energizing it. Relay RY1, in turn, activates RY2, which is used to handle the power requirements of the two recorders and SOL1.

The core of solenoid SOL1 rests against the on-hook button in the base of the telephone. When the solenoid is energized, its core is retracted releasing the on-hook button. At that point, one recorder plays its prerecorded message into the mouthpiece on the handset.

At the end of that message, the caller is allowed ample time to leave his message, which is picked up by the second recorder through a small microphone attached to the handset earphone. After a period, determined by the time constant of R1 and C1, relay RY1 is turned off. Relay RY2 then opens, removing power from the entire system. Relay R1 can be any 9-volt unit with 117-volt, 1-amp contacts. Relay RY2 has a 117-volt coil

NEW IDEAS

This column is devoted to new ideas, circuits, device applications, construction techniques, helpful hints, etc.

All published entries, upon publication, will earn \$25. In addition, for U.S. residents only, Panavise will donate their model 333—The Rapid Assembly Circuit Board Holder, having a retail price of \$39.95. It features an eight-position rotating adjustment, indexing at 45-degree increments, and six positive lock positions in the vertical plane, giving you a full ten-inch height adjustment for comfortable working.

I agree to the above terms, and grant *Radio-Electronics Magazine* the right to publish my idea and to subsequently republish my idea in collections or compilations of reprints of similar articles. I declare that the attached idea is my own original material and that its publication does not violate any other copyright. I also declare that this material has not been previously published.

Title of Idea

Signature

Print Name

Date

Street

City

State

Zip

Mail your idea along with this coupon

to: **New Ideas Radio-Electronics,**
500-B Bi-County Boulevard
Farmingdale, NY 11735

and its contacts are rated 117 volts AC at 10 amps.

With power cut off, the core of SOL1 is once again extended, pressing down on the on-hook button in the telephone base. The two tape recorders are plugged into sockets SO1 and SO2, so that when RY2 is energized, they are fed 117 volts AC. When using that scheme, the recorder with the prerecorded message should be left in the play position, while the other is left in the record mode.

—Donald J. Youkersur

FLUKE 70

SERIES MULTIMETERS



- 77 • 0.3% Accuracy
- Manual or Autorange
 - 10A + mA Range
 - Beeper
 - "Touch-Hold" Function

Sale
\$129.95
 75 89.95
 73 69.95

WE CARRY A FULL LINE OF FLUKE MULTI-METERS. IN STOCK NOW

SALE ENDS JUNE 30

BECKMAN'S CIRCUITMATE®

ALL UNDER \$100

AVAILABLE NOW...



\$64.95

Circuitmate DM-20—3 1/2-digit, pocket-size multimeter; 0.8% Vdc accuracy, diode test, hFE test, conductance, 10 amps AC and DC ranges, auto-polarity, auto-zero, auto-decimal



\$69.95

Circuitmate DM-40 — 3 1/2-digit multimeter; 0.8% Vdc accuracy, diode test, auto-polarity, auto-zero, auto-decimal



\$89.95

Circuitmate DM-45 — 3 1/2-digit multimeter; 0.5% Vdc accuracy, diode test, continuity beeper, 10 amps AC and DC ranges, auto-polarity, auto-zero, auto-decimal



\$79.95

Circuitmate DM-25—3 1/2 digit, pocket-size multimeter; 0.5% Vac accuracy, diode test, capacitance, continuity beeper, conductance, 10 amps AC and DC ranges, auto-polarity, auto-zero, auto-decimal

BK PRECISION DYNASCAN CORPORATION

BREAKS THE PRICE BARRIER WITH THESE HIGH PERFORMANCE OSCILLOSCOPES

100 MHz Dual Trace/ Dual Time Base

- 1 mV/div sensitivity
- 23 calibrated sweeps
- Rectangular CRT with internal graticule and scale illumination
- Signal Delay Line

\$995

Does not include probes (\$60.00 a pair when purchased with scope)

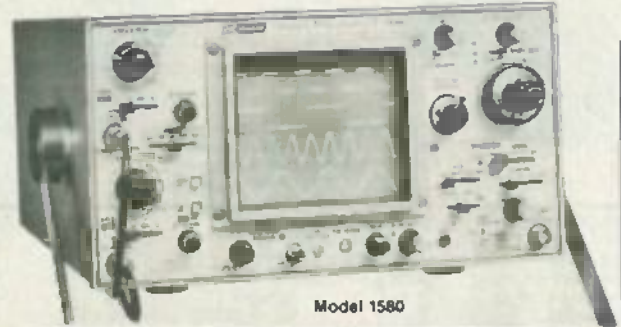

Model 1580

QUANTITIES ARE LIMITED

BK PRECISION



INDUSTRIAL TRANSISTOR TESTER

\$219.95

MODEL 520B

- Now with HI/LO Drive
- Works in-circuit when others won't
- Identifies all three transistor leads
- Random lead connection
- Audibly and visually indicates GOOD transistor

BK PRECISION

100 MHz Dual Time Base SCOPE

MODEL 1590

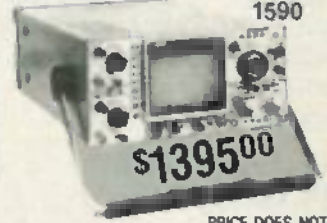

\$1395.00

PRICE DOES NOT INCLUDE PROBES

- 1mV/division sensitivity to 70 MHz
- 500 μV/division cascade sensitivity
- Four-input operation provides trigger view on 4 separate inputs
- Alternate time base operation
- Switching power supply delivers best efficiency and regulation at lowest weight



TOLL FREE HOT LINE

800-223-0474

212-730-7030

ADVANCE ELECTRONICS

26 WEST 46th STREET, NEW YORK, N.Y. 10036

Only NRI Gives You System for Total

You get it all . . . training for America's fastest growing career opportunity . . . training to service all computers . . . training on a total computer system. And only NRI training gives you all the skills and confidence to become a complete computer service technician.

Today, you can't successfully repair a computer with confidence unless you know that the peripheral equipment is operating properly. Only NRI can give you the well-rounded training you need because only NRI gives you a complete computer system . . . computer, monitor, disk drive, printer, software, even test instruments like a digital multimeter and logic probe. It all adds up to training that builds the knowledge, competence and ability you need to succeed as a computer service specialist.

Get inside the IBM PC compatible Sanyo

As an NRI student, you'll get total hands-on training as you actually build your own Sanyo 550 Series computer from the keyboard up. As you assemble it, you'll perform demonstrations and experiments that will give you a total mastery of computer operations and servicing techniques. You'll do programming in BASIC language—even run and interpret essential diagnostic software. You'll prepare interfaces for peripherals such as printers and joysticks. Using utility programs, you'll check

out the operation of the 8088 microprocessor. Step-by-step, NRI will guide you right into a high paying career in one of America's fastest growing fields.

New! Course now includes high performance printer
Only NRI includes an advanced

dot matrix printer as part of your hands-on training. Working with it, you'll get practical experience in adding peripherals, perform experiments bringing to life operating principles, and then go on to learn critical maintenance and servicing techniques, including changing the print head.



MONITOR High resolution monochrome monitor displays 80 crisp characters per line. Does equally well displaying high resolution graphics.

PRINTER Advanced dot matrix printer prints four sizes of italics and standard type at up to 120 cps bidirectionally in Near-Letter-Quality mode.

FLOPPY DISK AND PROGRAM Software includes MS-DOS 2.11 operating system, Sanyo BASIC, two word processing programs, a powerful spreadsheet program, and several useful NRI-written utility programs.

MANUALS Documentation covers the Sanyo computer as well as the professional programs included.

SANYO 550 SERIES COMPUTER has powerful 8088 CPU, runs many IBM PC programs, includes 256K RAM, double-sided double density disk drive, parallel printer port and detached intelligent keyboard.

A Total Computer Systems Training

Understanding you can get only through experience

You need no previous knowledge to succeed with NRI. You start with the basics, rapidly building on the fundamentals of electronics with bite-size lessons to master advanced concepts like digital

logic, microprocessors, and computer memories.

You'll reinforce this new understanding with hands-on practical demonstrations and experiments that give you real world experience. You'll use the exclusive NRI Discovery Lab to

see what makes transistors tick... build and test working electronic circuits that duplicate key computer circuitry... and construct digital logic circuits that demonstrate computer performance.

Do it at home in your spare time

NRI trains you in your own home at *your* convenience. You learn at your own pace, backed at all times by your own NRI instructor and the entire NRI staff of educators and engineers. They're always ready to answer questions, give you guidance, follow your progress, and help you over the rough spots to keep you moving toward your goal.

100 page free catalog tells more... send today

Send the postage-paid reply card today for NRI's 100 page catalog that gives all the facts about computer training plus career training in robotics, data communications, TV/audio/video servicing, and many other fields. You'll see how NRI can give you the skills and confidence you need for advancement, a new career—even a service business of your own in the existing world of electronics. If the card is missing, write to NRI at the address below.

DISCOVERY LAB Electronics comes to life on your NRI Discovery Lab*. You set up and modify prototype circuits, demonstrate action of components, gain valuable bench experience in construction, diagnosis, and repair of circuitry.

DIGITAL LOGIC PROBE Professional digital logic probe makes analyzing digital circuit operation a simple task.

LESSONS Bite-size lessons build knowledge and understanding step by step. Abundance of photos, illustrations and diagrams reinforce clear, easy-to-follow text.

DIGITAL MULTIMETER 3½ digit digital multimeter features liquid crystal display and four key functions. Your instructor talks you through its operation and professional use on Action Audio Cassette.

NRI SCHOOLS

McGraw-Hill Continuing Education Center
3939 Wisconsin Avenue
Washington, DC 20016

We'll give you tomorrow

Which Way To YOUR Future?

Are you at a crossroads in your career? Have you really thought about it? Are you *planning* for your future, or perhaps refusing to face the subject? Which way will you go — down the same old road? Or are you ready for something else?

In electronics you can't stand still. If you are not moving ahead, then you're falling behind. At the crossroads of your career, various choices are available — and, yes, *decisions* have to be made.

Which road will you take — one that doesn't go where you want to be, or one that leads to hard work *but also* to the better life? Ah, decisions, decisions!

Career decisions are so important that you need all the *input* you can get before locking-in on one of them. Grantham College of Engineering offers you *one* source of input which may help you in making that decision. It's our free catalog.

Ask for our free catalog and you may be surprised to learn how it is easily possible to earn a B.S. degree in electronics without attending traditional classes. Since you are already in electronics (you are, aren't you?), you can complete your B.S. degree work with Grantham while studying at home or at any convenient place.

But don't expect to earn that degree without hard work. Any degree that's worth your effort can't be had without giving effort to the task. And of course it is what you learn in the process, as much as the degree itself, that makes you stand out above the crowd — that places you in an enviable position, prestige-wise and financially.

Grantham College of Engineering
10570 Humbolt Street
Los Alamitos, California, 90720

This booklet
FREE!

This free booklet explains the Grantham B.S. Degree Program, offered by independent study to those who work in electronics.



for
FREE
Booklet
CLIP
COUPON
and mail in
envelope or
paste on
postal
card.

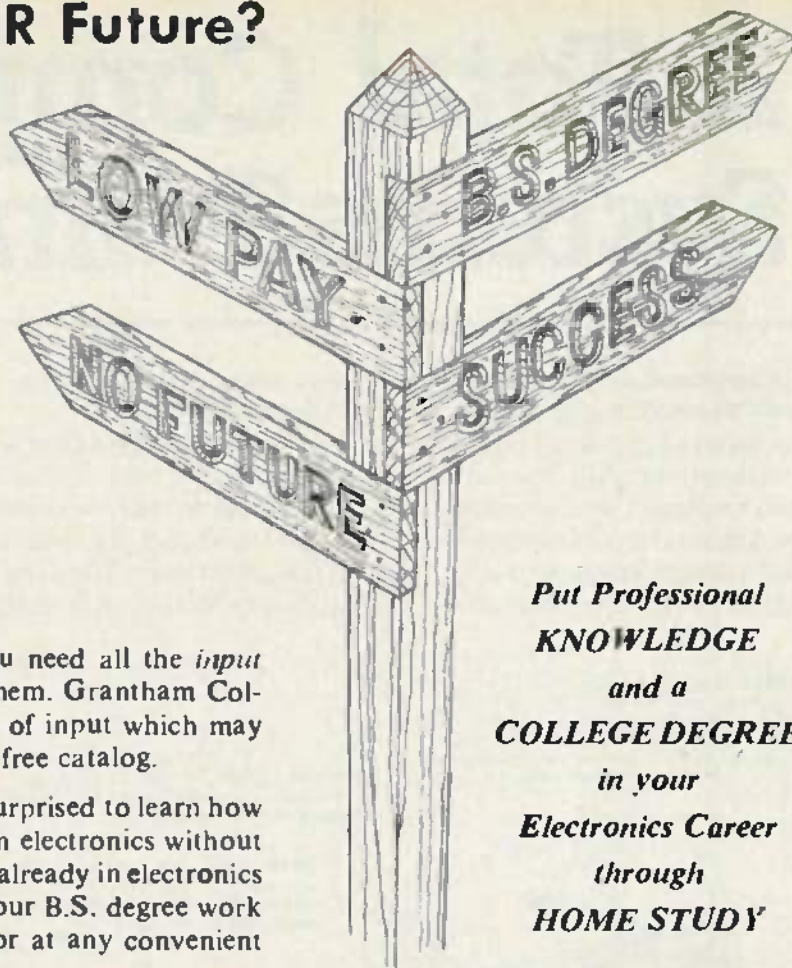

*Put Professional
KNOWLEDGE
and a
COLLEGE DEGREE
in your
Electronics Career
through
HOME STUDY*

Grantham offers this program, complete but without laboratory, to electronics technicians whose objectives are to upgrade their level of technical employment.

Recognition and Quality Assurance

Grantham College of Engineering is accredited by the Accrediting Commission of the National Home Study Council, as a degree-granting institution.

All lessons and other study materials, as well as communications between the college and students, are in the English language. However, we have students in many foreign countries; about 80% of our students live in the United States of America.

Grantham College of Engineering R-06-86
10570 Humbolt Street, Los Alamitos, CA 90720

Please mail me your free catalog which explains your B.S. Degree independent-study program.

Name _____ Age _____

Address _____

City _____ State _____ Zip _____

LASERS, LIKE TRANSISTORS AND digital computers, exemplify the way in which what was not too long ago a laboratory curiosity can become an inescapable part of daily life. While you may not yet own a laser-bearing device, you almost certainly use one every day.

Lasers carry communications on fiber-optic cables, play music from CD's, and read prices at supermarket checkout-counters. They perform surgery, help survey our highways, test the components of the airplanes we fly in.

Looking at LASERS

Although they have been practical for only 25 years, lasers today and all they make possible are an integral part of our daily lives.

Josef Bernard

and entertain us at rock concerts. They also make formidable weapons.

What is a laser?

A laser (which stands for *Light Amplification by Stimulated Emission of Radiation*) is a source of intense light that has several unusual and useful properties. The light is monochromatic, which means that it is a single, very pure, color whose frequency can be measured and used as a precision standard in and out of the laboratory. Laser light is coherent—all the waves of a beam are in phase. Unlike natural and most artificial light sources, whose emissions are incoherent, or phased randomly, a laser produces packets of photons all "marching in step", and possessing a great deal of energy. Finally, because of the way they are generated the rays of light produced by a laser are all parallel to one another, or very nearly so. A pencil-thin beam of laser light aimed at the moon will spread out to a diameter of only 1½ miles. That may not sound impressive—until you consider that the light would travel a distance of about 250,000 miles before diverging that far.

How lasers work

The principle behind the laser is called stimulated emission. That term refers to the fact that an atom, when in an excited state, can be made to emit a photon when bombarded by other photons or by another high-energy source such as a source of electrons.

That needs a little explaining. Figure 1-a shows a simple hydrogen atom—just a proton and an electron. The "height" of the orbit of the electron depends on the amount of energy that the electron is carrying and is very strictly defined by nature. Further, for an electron to be forced to jump from one orbit to another requires a precise amount of energy, or quantum, to be added to it.

In its lowest orbit, no energy has been added and the electron is in its normal, or ground, state. When just the right amount of energy is applied, the electron will jump to a higher orbit, and it is said to be excited (Fig. 1-b). That excited state, though, is unstable, so the electron quickly returns to its ground state. When it does that it gives up the energy that was applied to it, in the form of a photon, or particle of light. (Light is electromagnetic radiation but it frequently behaves like a particle. For that reason, a photon is sometimes called a "waveicle.") That spontaneous emission of photons is where laser light begins.

If you get enough excited atoms together, spontaneously emitting photons as they undergo the transition from the excited to the ground state, an interesting thing happens. When one of those photons strikes an already excited atom, it changes state and emits its own photon (Fig. 1-c).

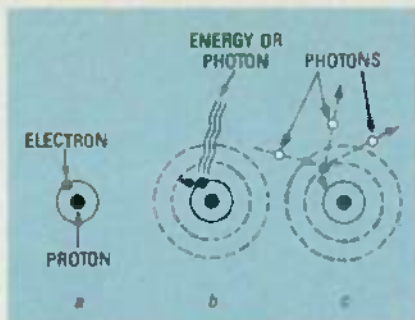

FIG. 1—A SIMPLE HYDROGEN ATOM is shown in a. If a precise amount of energy, or quantum, is added to the atom (b), the electron makes a transition from its normal ground state to a less-stable excited state and jumps to the next higher orbit. If a photon strikes the electron while it is in that excited state, the electron will return to the ground state and emit a photon of its own (c).

Thus, there are then two photons where previously there was one. Those two photons can go on to strike other excited atoms and generate still more photons—a process very much like what happens in a nuclear-fission reaction. That process of photons generating other photons from excited atoms is known as stimulated emission. A photon of a particular wavelength gives rise only to photons of the same wavelength. Thus, laser light is monochromatic; it contains only a single color.

The trick, of course, is to get together in one place a large number of excited atoms of the same kind, so that stimulated emission of photons can take place. That is done by pumping the atoms in a material up to an excited state by bombarding them with intense light or with some other source of energy such as a beam of electrons. With a ruby laser—the type used by Theodore Maiman on July 7, 1960 when he demonstrated the first laser—as an example, let's examine the lasing process.

A simple diagram of a ruby laser appears in Fig. 2. The heart of that device is a rod of synthetic ruby whose ends are finely ground and polished so they are optically flat and are exactly parallel to one another. Both ends of the rod are

silvered to reflect light back into it, but the reflecting surface at one end is not a perfect reflector—it allows perhaps ten percent of the light generated within the rod to escape. That light is the laser beam.

The rod is surrounded by a spirally-wrapped xenon flash tube similar to those used in electronic flash-units. The light produced by that tube will excite the atoms in the ruby rod. Because of that, that type of laser is known as an optically pumped laser. (As we shall see, there are other types of excitation commonly used.) The cooling equipment is present to remove the heat generated by the lasing device. Lasers are extremely inefficient—only one or two percent of the power they consume is transformed into usable laser light; the rest is given off as ordinary light and lots of heat. That isn't really too bad though—an ordinary incandescent bulb is only about two percent efficient, and the light it produces can't begin to compare with that from a laser.

When the flash tube discharges, the photons it emits enter the ruby rod through its sides and excite the material's chromium atoms, which absorb green and blue light. (Those atoms are what give the ruby its reddish color; you may remember from physics that whatever light a material doesn't reflect or transmit, it absorbs.) When those excited atoms decay from their excited state they give off photons, which trigger other excited atoms to release photons, and so on. The whole process in a ruby laser takes place in about 300 microseconds, and an intense burst of ruby-red light is produced.

We now have lots of light, but we still don't have a laser. That's where the reflective end surfaces of the rod come in. Most of the red light generated within the rod escapes through the sides, but some of it is reflected back into the rod, and that gives rise to the stimulated emission of more red light (hence the "amplification" in the word "laser").

A portion of the light is not reflected, however, but escapes from the rod through the end that is only partially silvered. That

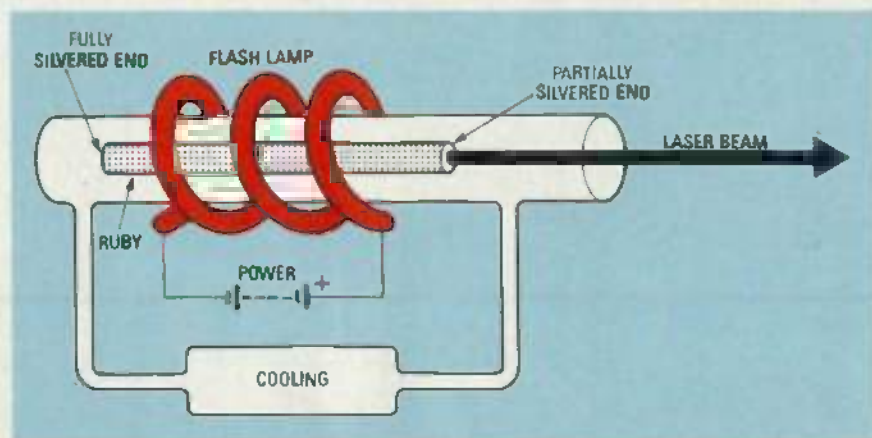

FIG. 2—IN THIS OPTICALLY-PUMPED LASER the light produced by a xenon flash lamp is used to excite the atoms in a ruby rod.

is the laser beam. It is monochromatic because the photons that trigger stimulated emission give rise only to photons like themselves. It is also coherent—all the light waves are in phase. That, too, is a result of the process of stimulated emission; the phase of the photons generated is identical to that of the stimulating photon. The rest of the light reflected by the rod's mirrored ends bounces back to interact with more chromium atoms and produce more photons.

Figures 3-a and 3-b, respectively, represent coherent and incoherent (random phase) light. As is the case with any wave phenomenon—we're now considering photons as waves rather than as particles—out-of-phase waves tend to cancel each other. Because all the waves of a laser beam are in phase, it is much more intense and powerful than a beam of ordinary incoherent light.

Finally, all of the photons in a laser beam travel parallel to one another. That is the result of the orientation of the reflecting surfaces at the ends of the lasing element. The beam of even an inexpensive laser has a divergence of only about one-twentieth of a degree, which means that the energy it carries is not diffused appreciably over distance.

There are many, many types of lasers, and their characteristics and modes of operation tend to overlap. The following examples are just a small cross section of what has been developed in the past 25 years.

Crystal lasers

This is the category to which the original ruby laser belongs. Those lasers are optically pumped and have a relatively low-power output, in the milliwatt range. The most common type is the neodymium-YAG (for Yttrium-Aluminum-Garnet) laser, which emits light in the near-infrared. YAG lasers can be operated continuously because the material from which they're made conducts heat, which would otherwise destroy the laser rod, relatively well.

Another member of the crystal-laser family is the neodymium-glass laser. It is less expensive to produce than the YAG type (glass is cheaper than garnet, even the synthetic kind), but it must be pulsed, or operated on a one-shot basis. It cannot sustain continuous operation because of glass's poor heat conductivity.

Gas lasers

There are more gas lasers than there are any other type. Over 5000 types of laser activity in gases are known. Gas lasers are not usually optically pumped, but are energized by passing an electric current at a potential of several thousand volts through the gas, which is contained in a tube with polished and silvered faces similar to the ends of the ruby rod described earlier. As



FIG. 3—IN LASER LIGHT, all of the waves are in phase; thus they are said to be coherent (a). In normal light, the waves have no phase relationship (b).

the current flows through the gas, the electrons transfer some of their energy to it, bringing it to a state where the stimulated emission of photons can occur. Because of the way they're constructed, gas lasers can be cooled more efficiently than crystal types, and lend themselves better to continuous operation.

The most widely used gas laser is the helium-argon laser, which can be built for a modest sum by almost any experimenter. It is able to produce no more than 50 milliwatts, but its tight beam of red light, about a millimeter across, makes it ideal for laboratory and experimental use.

Argon and krypton lasers can produce a wide range of colors, but are still relatively low in power. It is not feasible, for example, to construct an argon laser more powerful than 100 watts. Argon lasers with their green light are frequently used in medical applications.

The infrared carbon-dioxide laser is more of a heavyweight. It can have an output as high as several hundred kilowatts. Moderate-sized lasers of that sort are widely used in industry.

Liquid lasers

Organic dyes dissolved in organic compounds such as alcohol can be made to lase, too. Organic lasers are unusual in that one laser can produce a wide range of colors. That spectrum can be optically tuned, and a very precise selection of light of a single color can be made. That capability makes the dye laser a very valuable laboratory tool.

Semiconductor lasers

Semiconductor lasers (Fig. 4) are members of the LED family. They differ from ordinary LED's in that they consume considerably more current and the edges of the semiconductor die are polished to form interior reflecting surfaces. Because of their extremely small size—about as big as a grain of salt—and the difficulty of removing the heat they generate, those lasers do not have a very high output. Still, there are many applications to which they are well suited, among them fiber-optic communications and compact-disc players.

Laser applications

In the 25 years since they came into existence, lasers have proven themselves invaluable in a diverse range of fields. Here are a few of them:

Industry: The high temperatures produced by focused laser beams make them excellent tools for welding, cutting, and

drilling. A pinpoint of coherent light can cut or bore much more cleanly than its mechanical equivalent, with much less waste. (An informal, and entirely unofficial, system for rating the strength of lasers measures their power in terms of "Gillettes"—the number of razor blades that a beam of laser light can successfully punch through.)

Photographs taken by laser light can be used to determine stress regions and faults



FIG. 4—THIS SEMICONDUCTOR LASER is so tiny that it can fit in the eye of an ordinary sewing needle. Photo courtesy of ATT Bell Laboratories.

in materials, simplifying and improving quality control procedures in critical applications. Lasers are also used in industry for non-contact monitoring of a wide variety of systems. See Fig. 5.

Medicine: Lasers find applications in numerous areas of medicine, among them dermatology, gynecology, and many areas of surgery. The finely focused beam of a laser can operate in areas (such as the inside of the eye) inaccessible to the traditional scalpel.

Science: Lasers have helped scientists both to refine existing knowledge and to learn more about our universe. Using lasers, it has been possible to determine



FIG. 5—LASERS HAVE many applications in industry. Here's a device that uses a laser to monitor the performance of an ultrasonic wire bonder, which is used in electronics production.

the speed of light (186,282,398 miles/second; 299,792,458 kilometers/second) with an accuracy hitherto unknown, and other units of measures have also benefited. A laser beam follows what must be the world's straightest line, a boon for surveyors and the like. Lasers in the laboratory have also allowed the development of new techniques to perform tasks that were previously impossible. Nuclear fusion reactions making possible the generation of enormous quantities of inexpensive electricity from plain seawater will probably be initiated and sustained by lasers.

Communications: Right now fiber-optic communications links using semiconductor lasers are in limited use, but their potential for carrying vast quantities of information makes it certain that as new installations are made, they will become much more common. In space, where laser light cannot be attenuated by air, it may carry communications and data from satellite to satellite, or even to earth. Lasers also are the heart, of course, of the laser printers; those devices, with their high-quality outputs, are now becoming popular in computer circles.

Entertainment: Laser-light shows are popular at rock concerts, and lasers are also used to record and read the information contained on CD's and most videodiscs. Holography, practical only with laser light, makes possible 3-D photography without a camera or special viewing device, and has given birth to a new art form. One day we may enjoy holographic movies, although holographic television at this point seems rather far-fetched because of the limited resolution of even the most sophisticated video systems. The applications of holography, of course, are not limited to the world of entertainment. Holographic techniques are also used in devices like scanners for UPC (Universal Product Code) readers in stores, and in the restoration of artwork.

War: Like dynamite, lasers can be put to both peaceful and destructive uses. Currently in the headlines is the "Star Wars" technology that will take the science of war into the peace of space. Lasers are also used in the navigation systems of missiles and in targeting devices.

New uses for the unique qualities of laser light are constantly being conceived. Among some of the more unusual and esoteric areas being explored are dental holography, gene manipulation, acupuncture, laser-based optical computers, and the use of lasers to transmit power from solar-energy-gathering satellites. Future applications of the laser may only be limited by the scope of human imagination.

It doesn't take much to see that the invention of the laser is one of the most significant things to come out of the laboratory in this century. **R-E**

BUILD THIS

HELIUM — NEON LASER

Build this simple helium-neon laser and start
having fun with photons!

ROBERT GROSSBLATT and ROBERT IANNINI

BACK IN THE HEYDAY OF SCIENCE FICTION'S era of purple prose, tales of bug-eyed monsters, death rays, and the like filled many a pulp magazine. Of course, we knew then that it was all just fantasy; you could no more have a "death ray" than you could travel faster than sound or put a man on the moon.

While those bug-eyed monsters (or BEM's, for short) have yet to pay us a visit (to the best of our knowledge), much of yesterday's science fiction is today's science fact. We even have a death ray, of sorts. Of course, we are referring to the laser, which can be a powerful weapon in the hands of those who wish to use it as such.

But the laser is also a great tool for science and industry. In just 25 years the laser has gone from far-fetched notion, to scientific reality, to common noun. Hardly a day goes by where some part of our lives is not affected by lasers. Today, the laser has joined the transistor as a hallmark of modern electronics.

What's a laser?

The word *laser* is an acronym for Light Amplification by Stimulated Emission of Radiation. But for most of us, that provides a poor explanation of what a laser is and how it works. To find a better explanation, we have to leave electronics for a while, drop into the world of physics, and talk a little bit about the nature of

light. You can't understand laser light until you have some familiarity with the properties of light in general.

There are three ways in which laser light differs from ordinary light, and each of those differences contributes to the special characteristics of a laser. Let's begin by looking at some of the characteristics of ordinary light.

Ordinary light has a relatively wide bandwidth. That means that a spectrographic analysis would reveal that regular light is made up of many different wavelengths. Just about everybody has seen, or done, the experiment in which a beam of white light is directed through a prism and split into different colors. The ordinary light we see as white, therefore, is actually made up of different color elements—it's *polychromatic*. Figure 1 shows the composition of visible light, and the relative sensitivity of the human eye to various wavelengths.

Ordinary light is also *temporally incoherent*. By that we mean that the various components of the light do not share any time relationship; they are all randomly out-of-phase with respect to each other. Thus, if you were able to look at the waveform of a beam of ordinary light, you would see something that looks like Fig. 2. The irregularity and random appearance of that waveform is caused by the presence of waveforms of differing frequencies in the light, and the ways in



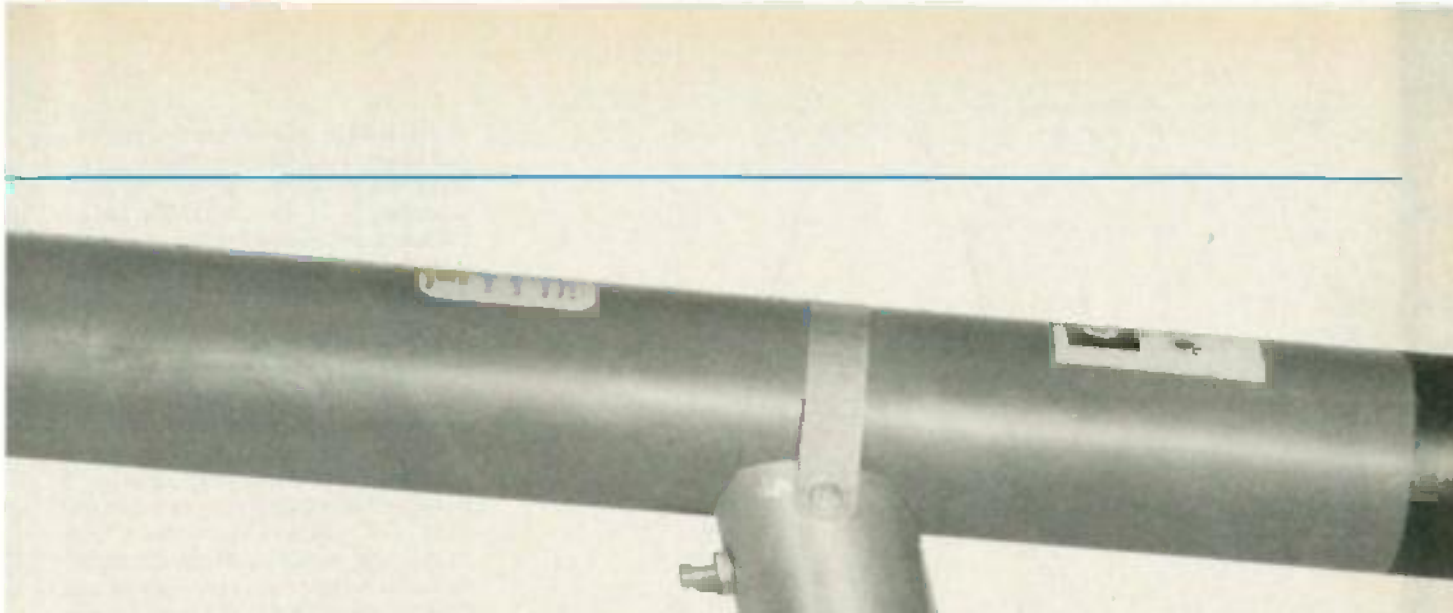

which those waveforms interact with each others. Because of that interaction, at some points the waveforms all add (constructive interference); at some points they all subtract from one another (destructive interference), and at most points a combination of the two effects occurs. The result is an irregular, random-appearing waveform as shown.

Finally, ordinary light is also *spatially incoherent*. If you were to analyze the waveform of Fig. 2 over a period of time you would see that it is constantly changing. That's because the component waveforms are constantly changing their positions with respect to each other, causing the interference effects to vary.

The best way to put the differences between ordinary and laser light in perspective is to compare light to sound. Ordinary light, because of all the things we just talked about, can best be compared to noise. The waveforms at any moment in time are not only randomly spaced, but there's an unpredictable mix of frequencies as well.

Now, if regular light is like noise, then laser light can only be thought of as the purest sound imaginable. For openers, laser light is highly monochromatic—a spectrographic analysis would show that it is composed of light of only one wavelength. And where regular light is temporally incoherent, a laser is temporally coherent—all of the light waveforms are in phase with each other. That is one of the reasons why a laser puts out light of such pure color. Being monochromatic helps, of course, but being temporally coherent as well means that there's almost a complete absence of what would be called distortion in a sound wave.

As you might have already guessed, laser light is also spatially coherent. If you looked at the waveforms over a period of time, there would be absolutely no shifting or movement. Considering the absence of interference effects, that is exactly what you would expect to happen.

Taken together, all of those factors are what make laser light so intense, and so directional.

Since laser light is just about interference free, there's almost no scattering of the light. The beam divergence is very small—in the milliradian range. A laser beam is really a beam of light! Being coherent also means that there's a much smaller loss in energy over distance than there is with regular light. Obviously, since laser light is so different from regular light, it can't be produced the same way. And in order for us to understand how it's produced, let's see how regular light is produced.

Electromagnetic waves in general, and light in particular, is produced when an atom gives off energy. Now, an atom either takes on energy (absorption), or gives off energy (emission), by having its electrons move from one energy level to another. Once energy has been supplied to the system, and absorbed by the atom, emission can occur in one of two ways—it can happen spontaneously, or it can be stimulated.

Spontaneous emission is the result of natural atomic decay. The electrons randomly drop in energy level and produce the kind of waveforms shown in Fig. 2. When you power up a light bulb, for example, the atoms in the filament absorb energy and release it as a combination of heat and ordinary, incoherent light.

Stimulated emission is a completely different process. The idea is to keep the atoms from releasing their absorbed energy in a random manner. In order to do that, you have to create a state of affairs called a "population inversion." In simple terms, that means that there have to be

more atoms present that have absorbed energy than there are atoms that have already released energy. That is usually brought about by forcing enough energy into the system to create at least three atomic-energy levels. The most excited atoms will emit energy and drop down to the next lowest energy level. That means there will be more atoms at the intermediate level than there are at the lowest level—that's the population inversion we mentioned.

As photons of energy are released, they will cause other atoms to emit energy in the form of photons. Those photons will trigger the production of other photons. And if the emission is bounced back and forth between two mirrors the production of photons will continue to build in phase and the result will be, you guessed it, a beam of laser light with a waveform that looks like that shown in Fig. 3.

Making a laser

Now, understanding the basic theory and putting it into practice are, as we all know, two completely different things. Creating the population inversion you need to produce a laser beam is really an iffy, ticklish business. Everything has to be just so or nothing will happen. The mirrors have to be of a certain type to produce the in-phase coherent energy needed for a laser. And enough energy of the right type has to be forced into the system to make the whole thing work.

The kind of energy you have to pump into the system depends on the type of material you're trying to make lase. Semiconductor and gas lasers are pumped up with electrical energy while crystalline lasers, such as those made from ruby rods or YAG (Yttrium-Aluminum-Garnet) are usually pumped up optically with xenon flash tubes or arc lamps.

The laser we're building here is a gas

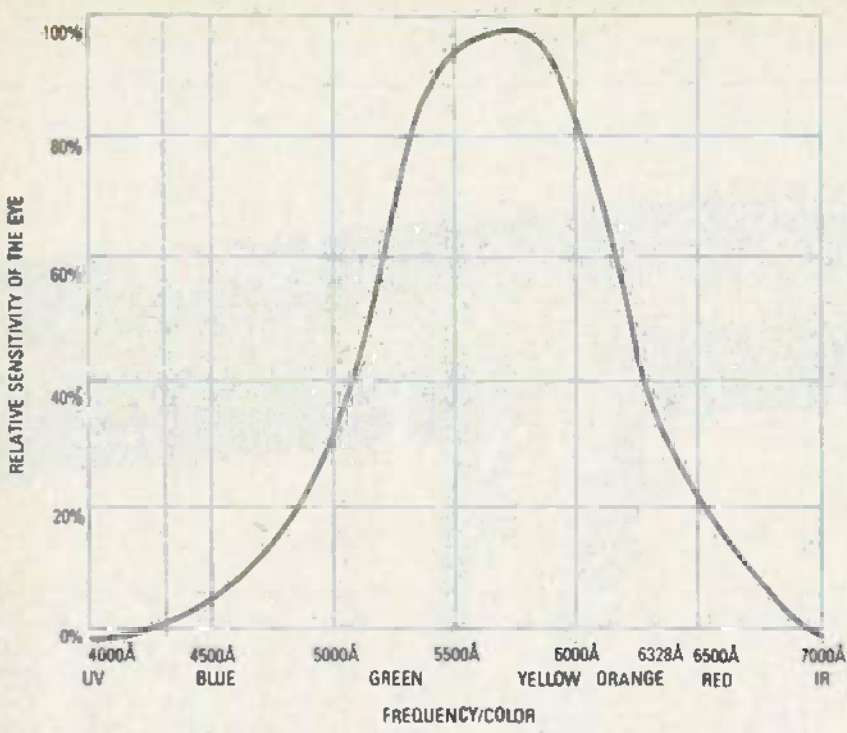

FIG. 1—THE VISIBLE SPECTRUM, and how the human eye responds to it. The wavelength of the light emitted by our helium-neon laser is 6328 Angstroms.

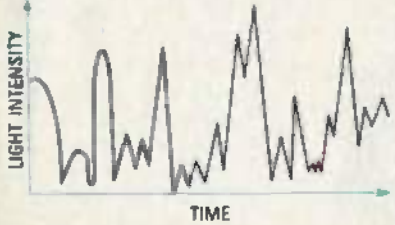

FIG. 2—THIS RANDOM-APPEARING waveform is that of ordinary light. The waveform is made up of all of the various frequencies that make up such light.

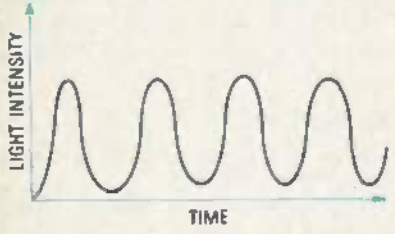

FIG. 3—LASER LIGHT is made up of light of just one frequency. It is the purest type of light possible.

laser—more specifically a helium-neon laser. The frequency of the light is 6328 Angstroms and the laser puts out about 1 milliwatt with a beam divergence of 1.3 milliradians. Now, 1 milliwatt may not sound like a lot of to you, but that's because you're still thinking in terms of regular light. Remember that the laser produces a highly directional beam of coherent, monochromatic light. The laser we're talking about here generates a beam that can be spotted on a wall more than two miles away!

Helium-neon lasers are extremely inefficient and, in order to make them work,

the mechanical setup of the laser tube has to be just about perfect. It has to be properly sealed and contain the correct gas mixture. Also, the mirrors have to be perfectly aligned dielectric ones so enough reflection takes place at the proper frequency to cause the device to lase. Those mirrors must be highly reflective, within a couple of decimal places of 100%; by contrast, the silver mirrors we use every day have a reflectance factor of only 95%.

Making a helium-neon laser tube is a project that is beyond the means of most of us as it requires a fair amount of skill and equipment. Among other things, you need to have the skills and equipment required to create a precise mixture of gases, and you need to be adept at glass blowing. All of that is not impossible, of course, but in most cases it's a task that is best left to someone else; we recommend that you purchase rather than build a tube. (One source for laser tubes is mentioned in the Parts List.)

Once you have a working laser tube, actually making it produce a beam is surprisingly simple. The only electronic assembly needed is a power supply that will deliver the right voltage to make the tube fire. Figure 4 is the schematic of a power supply that can be used to trigger the laser. If it looks familiar, that's because its front end is essentially the same one used in the construction of the infrared viewer that appeared in the August 1985 issue of *Radio-Electronics*.

The power supply is a switcher with Q1, Q2, and their related components forming an oscillator that switches a square-wave through the primary windings of T1,

a high voltage step-up transformer. That part of the circuit takes the battery voltage and produces about 400 volts AC at the secondary of T1. Diodes D3-D6 and capacitors C2-C5 form a voltage multiplier that takes the 400 volts from T1 and boosts it to the 1600-volts DC needed to ignite the laser tube.

The high-voltage pulse needed to ignite the tube comes from an 800-volt tap on the voltage multiplier. Resistors R3 and R4 divide that voltage to provide the 400 volts needed to charge up C9, the dump capacitor. When the SCR fires, the charge on C9 is dumped into the primary of the trigger coil, T2. Capacitor C11 charges up and, since it's in parallel with the laser tube, when the voltage builds enough to excite the gas, ignition takes place and current flows through the tube. That causes a voltage drop across R10, which turns on Q4 and turns off Q3.

As soon as the laser tube ignites, therefore, the ignition circuitry is turned off. That saves battery power because the laser tube can sustain firing at a lower voltage. The relaxation oscillator made up of Q3 and Q4, and their related components is only needed to control the firing of the SCR. Once the tube starts to lase, the voltage drop across R10 keeps the ignition circuitry turned off. If the tube stops lasing, the R9-R10 junction will drop to ground again and Q4 will turn off and unclamp Q3. The SCR will start firing again and, we hope, re-ignite the tube.

Construction

Before we actually start building the circuit, there's one very important thing you *must* keep in mind:

CAUTION! The power supply can produce as much as 10,000 volts at about 5 milliamps. That is enough juice to do a lot of damage. If you're not careful you can give yourself a severe shock. Remember that the capacitors take a while to discharge completely. You can get a real jolt even if the circuit has been turned off for five or ten minutes. Treat the circuit with respect and make sure to discharge the capacitors if you want to do some work on the circuit.

Now that that's out of the way, you can build the power supply on perfboard or use the PC board that's provided in our PC Service section, elsewhere in this magazine. If you use perfboard, remember to keep the leads as short as possible because there's a lot of high-frequency AC running around part of the circuit. Whichever method you use, make sure to keep any metal objects and your fingers away from the output section located around T2 and R11. Those are the points of the circuit where the highest voltages can be found. One short second of carelessness on your part and you're going to get zapped. If you're lucky, all it will do is hurt a lot.

The only other components in the cir-

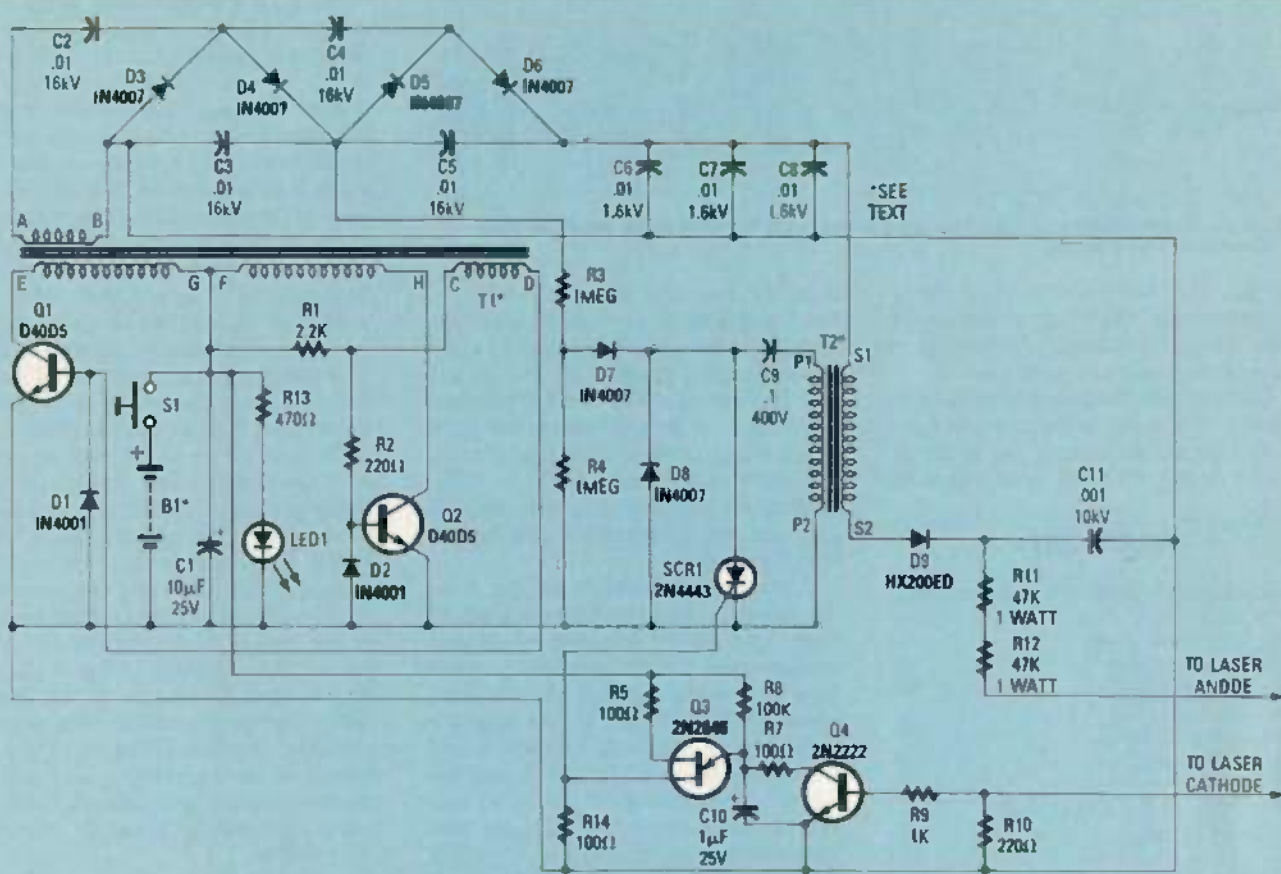

FIG. 4—THIS POWER SUPPLY is all you need to drive a laser tube like the one available from the supplier mentioned in the Parts List.

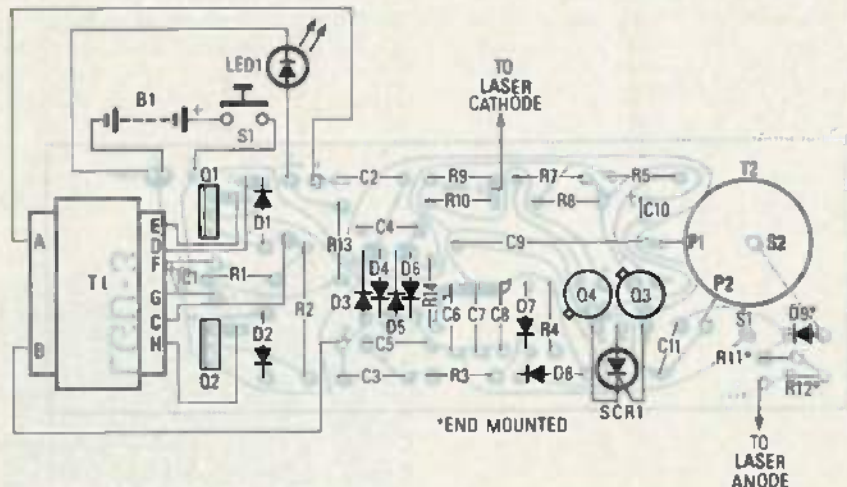

FIG. 5—IF YOU CHOOSE to use the PC board provided in our PC Service section, use this parts-placement diagram.

uit that require special attention are the switching transistors, Q1 and Q2. The maximum current draw from the batteries is about 750 mA, so those transistors will be handling a lot of juice and getting hot. The PC-board layout shown in Fig. 5 is designed so that the transistors can be placed in such a way that their tabs can be stuck against the laminations of T1. If you are using perforated construction board, be sure that your layout allows for that, too. Use some heat-sink compound to get good thermal contact, and using small

heat sinks wouldn't be a bad idea. After you've identified the components and found their position on the board, solder them in using a minimum of solder. Once you've done that, use some high-voltage putty, paraffin, or varnish to cover the traces (or wires if you're using perf-board) that connect to all the components on the secondary side of T2 and the laser tube. That part of the circuit has the highest voltages and it's likely that arcing will take place if all the bare metal isn't covered. You may find it necessary to use the

same material on the component side of the board as well.

When you finish the board, check for bridges, opens, bad solder joints, and so on. If everything seems OK, you're ready to test the power supply. Take the two leads that normally would go to the laser tube and tape them down so that they're 1/4-inch apart. Connect 10 volts to the power supply. You should see arcing across the laser-tube leads at a rate of about once a second or so; the circuit should be drawing approximately 250 mA. If the spark becomes continuous, the current draw should jump to about 750 mA—the full operating current of the laser tube. If you measure the voltage across the output of the supply, you should see an open circuit voltage of about 2500. Once the laser tube is connected, the voltage will be in the neighborhood of 1500.

If you've gotten this far without any brain damage, you're ready to connect the tube to the supply.

CAUTION! The laser tube is an expensive, delicate piece of equipment. In order to connect it to the circuit you'll be soldering leads to the metal collars at either end of the tube. Use a minimum of solder and apply heat for a minimum amount of time. Don't ever forget that the tube has a high vacuum inside and you can damage more than the tube if you destroy the integrity of

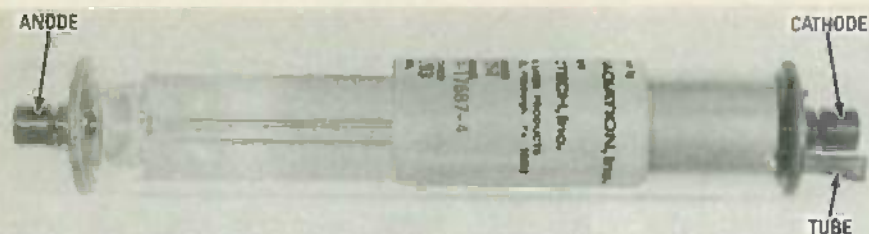

FIG. 6—A HELIUM-NEON laser tube. The cathode end can be identified by the small tube used to fill the laser tube with gas.

the seal. Use a low-power iron and a lot of common sense when you solder to the tube. Tin the wires ahead of time to keep the soldering time to a minimum.

The laser tube has an anode and a cathode end. The anode is the clear glass end of the tube and the cathode can be identified by finding the small metal tube used

to fill the laser tube with gas. See Fig. 6. Once you have the ends of the laser tube identified, solder the lead from R12 to the anode, keeping that lead as short as you can. The voltage at R12 is about 1100 volts when the tube fires, so that is the point where arcing or some other type of parasitic power loss is most likely to occur. Keeping the lead as short as possible will go a long way toward eliminating any potential problems.

Connect the cathode of the tube through an ammeter to R10 and apply 10 volts to the supply. The tube should start sputtering as it tries to ignite. As you raise the voltage slowly, ignition will take place and the tube will fire. If you raise the supply voltage to 12 volts, you should find the tube drawing about 5 mA and the supply will be putting out about 750 mA. The operating current of the laser tube should be kept in the range of 4.5 to 5.5 mA. Less than that and the tube won't operate reliably; more than that and you'll cut down its operating lifetime. You can trim the values of R11 and R12 to get the operating current into the safe range. Just make sure you keep the total resistance of R11 and R12 at about 100,000 ohms.

The current through the tube is going to vary a lot as the battery voltage changes. If you use nickel-cadmium cells, remember that the operating voltage is going to be 1.2 in each cell for most of the lifetime of each charge. Freshly charged nickel-cadmium cells, however, can have a voltage as high as 1.5. Admittedly that doesn't last very long, but we'll mention it because adjusting the laser tube's operating current with freshly charged batteries could cause you to choose artificially high values for R11 and R12. So before you start trimming the resistors, make sure the batteries are at 1.2 volts per cell.

Since the operating current is tied to the supply voltage, it's natural to think about voltage regulation. Well, there is nothing wrong with regulating the input voltage, but there are a few things to keep in mind. If you use 12 nickel-cadmium cells, you'll have a supply voltage of 14.4 and you'll be drawing as much as 750 mA from that supply. A three-terminal regulator like the 7812 would seem to be an ideal choice, but asking it to supply 750 mA is really asking a lot unless you use a 7812C, which can handle 1 amp with a good heat sink. An LM317 can be set up to put out 12 volts and it can supply 750 mA.

The biggest problem with using an IC voltage-regulator is the voltage loss that's inherent in those devices. In order to supply 12 volts, a regulator needs an input voltage of about 14.5 volts. Now that's just about the maximum you can get from the batteries. And if your particular tube wants a little bit more than 12 volts, or some of the power-supply components are a little bit lossy, you're in a lot of trouble.

So, you ask, what's the bottom line. Well, after all's said and done, unless you want to do an awful lot of circuit design, the best thing to do is let the power supply look directly at the batteries. It's not the best solution in the world, but it's probably the best thing in this situation.

The case for the laser can be as simple or as fancy as you like. Perhaps the simplest and most functional approach would be to use some lengths of standard PVC tubing. But if you do that, or completely enclose the circuit in any way, you could run into an overheating problem because of the amount of heat produced by the power supply. Because of that, it's a good idea to limit the on-time to less than a minute; keeping it under 30 seconds is even better. Further, giving the supply a 5-second or so rest between uses will increase its lifetime tremendously. Also, the better you heatsink Q1 and Q2, the better off you'll be.

Having fun

The output of the laser tube is about 1 milliwatt (or 0.4 milliwatt if the lower-powered tube offered by the supplier mentioned in the Parts List is used) and, at that power, it can't do any damage. If you had thoughts of burning your way through steel, forget it. Lasers that can do that are worlds away from the one we're building. However, that doesn't mean you can treat the light from this laser with no respect whatsoever.

CAUTION! Even a 1-milliwatt laser can be hazardous if you look directly at the beam. While we assume that anyone considering building a laser would know enough about those devices to never, never even consider doing something so foolhardy, the very nature of laser might make it very easy for accidents to happen. The beam is highly directional and very intense; to compound matters, the reflected beam is just as dangerous as the emitted beam. It's a simple matter to have the beam bounce off some shiny object and reflect back to you. You can wear safety glasses, but even if you do, be careful where and how you use the laser.

While you can use this laser, which throws an intense red beam, for such things as target spotting, perhaps its greatest use is as an introduction to the world of lasers in general. Watching the tube fire is truly fascinating and the more you experiment with it, the more you'll learn.

R-E

PARTS LIST

All resistors $\frac{1}{4}$ watt, 10% unless noted

- R1—2200 ohms
- R2—220 ohms, 1 watt
- R3, R4—1 megohm
- R5, R7—100 ohms
- R6—not used
- R8—100,000 ohms
- R9—1000 ohms
- R10—220 ohms
- R11, R12—47,000 ohms, 1 watt
- R13—470 ohms

Capacitors

- C1—10 μ F, 25 volts, electrolytic
- C2—C8—0.01 μ F, 1.6 kV, ceramic disc
- C9—0.1 μ F, 400 volts, paper dielectric
- C10—1 μ F, 50 volts, electrolytic
- C11—0.001 μ F, 10 kV, ceramic

Semiconductors

- D1, D2—1N4001
- D3—D8—1N4007
- D9—HX200ED, 20 kV diode
- LED1—Red LED
- Q1, Q2—D40D5, NPN power transistor
- Q3—2N2646—UJT transistor
- Q4—PN2222 NPN transistor
- SCR1—2N4443 SCR

Other components

- T1—12 to 400 volts, 10 kHz switching transformer
- T2—10-kV trigger transformer, 400-volt primary
- B1—14.4 volts, 12 nickel-cadmium cells, or equivalent
- S1—SPST switch, momentary pushbutton, normally open

Miscellaneous: PC board, helium-neon laser tube, PVC tubing for case, battery holders, wire, solder, etc.

Note: The following are available from Information Unlimited, PO Box 716, Amherst, NH 03031: PC board, \$4.50; switching transformer (T1), \$14.50; trigger transformer (T2), \$11.50; 1-milliwatt laser tube, \$149.50; 0.4-milliwatt laser tube, \$99.50; high-voltage diode (D9), \$3.50; high-voltage capacitor (C11), \$3.00.

TV SIGNAL DESCRAMBLING

Learn all about the techniques used by the pay-TV and cable companies to keep unauthorized viewers from pirating their signals.

WILLIAM SHEETS and RUDOLF F. GRAF

THANKS, IN PART, TO THE EXPLOSIVE growth of the video marketplace, it is rare these days to find a home that does not have access to some form of "pay-TV." By pay-TV we are, of course, referring to some type of premium programming that is provided to the viewer at a cost. Pay-TV can take many forms. It can be delivered via cable, satellite, multi-point distribution system (terrestrial microwave), or over-the-air subscription TV, and pay-TV can be charged for on a fixed-fee or per-program basis.

Obviously, for such a system to succeed, there needs to be some means to collect the charges for the premium channels or individual programs, and to prevent unauthorized reception by non-paying viewers. The most popular way of doing that is scrambling—encoding the signal so that it is unwatchable and/or inaudible to nonsubscribers. If a signal is properly scrambled, there is no way to adjust the television receiver so that a usable signal can be seen or heard.

In order to receive the signal, a device called a decoder or a descrambler must be used; that device is generally located between the antenna (or cable output) and the television receiver.

There are many different scrambling and descrambling techniques. Some scrambling schemes are basically very simple and provide only minimal security. Others are very sophisticated, and expensive. Thus, while they provide a high level of security, they are not currently practical for home-TV use. However, that may not always be the case. The recent development of low-cost, mass-produced digital-

TV IC's may make highly sophisticated, secure scrambling economically feasible for home use in the not-too-distant future.

In this series of articles we are going to discuss several scrambling-descrambling systems. All of those systems are either currently in use or possible in theory. Both system operation and circuitry will be described. Also, we will describe several experimental decoders, for those who wish to gain hands-on knowledge of the technologies involved (see text box), and we'll describe a device to scramble an existing video program. You may find the scrambling circuit useful for such things as protecting private information on your own videotapes from either unauthorized viewing or copying.

Incidentally, these articles are not intended to aid anyone with the theft of signal. In most instances, the theft of signal from a cable company, over-the-air pay-TV company, etc., is a crime, punishable by fines, and in some cases jail. Even if it were not, in many cases it would be more economical simply to subscribe and pay the fee. Decoders are expensive to buy and time consuming to build. And if, after you've spent the time and/or money for an illegal decoder, you find you don't like the programming, you are stuck with the equipment.

The video signal

In order to understand how scrambling works, you need some knowledge of the structure of a normal (not scrambled) video signal. Figure 1-a shows a simplified NTSC signal; in the U.S. and Canada, that is the composite-video signal that is

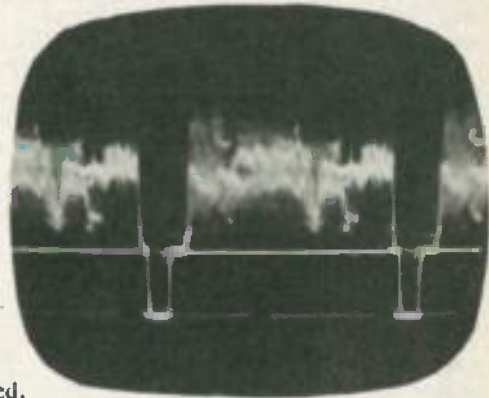

Over the next few months, Radio-Electronics will be presenting a series of articles describing the techniques used by pay-TV and cable companies to scramble their signals. While specific circuits for specific scrambling systems will be discussed, they are presented for informational and experimental purposes only. Therefore, parts lists, parts suppliers, and additional technical support will not be available for those circuits.

transmitted by your local TV station. In that signal, the video information appears between high-amplitude pulses. The effects of those pulses are not readily apparent on the screen, but they play an important role in the creation of the TV image.

The pulses are actually made up of several components. The widest part is called the horizontal blanking pulse. The purpose of the blanking pulse is to eliminate the visible effect of the bright vertical-retrace lines. It does that by "turning off" the CRT during retrace. Piggy-backed on the blanking pulse is the horizontal-sync pulse; its purpose is to synchronize the TV's horizontal sweep circuitry to the video signal.

Right after the horizontal-sync pulse's trailing edge, but before the blanking-pulse's trailing edge (that region is called the "back porch") is a signal consisting of

eight cycles of a 3.58 MHz sine wave. That signal is the color-sync (burst) signal; it is absent if the transmitted program is black and white. It is used to synchronize the color circuitry in the TV receiver and to turn on the color circuitry for color programs. In its absence (B/W program), the color circuitry in the TV receiver shuts down; that prevents colored noise and streaks from interfering with a black-and-white program.

There are 15,734 horizontal-sync pulses transmitted per second corresponding to each of the 525 lines of 59.94 fields transmitted per second. Each field consists of 262½ lines (interlaced scanning), and two fields make a frame. Alternate lines are scanned on each field. For simplicity, we will round off those numbers to 15,750—horizontal and 30—vertical frames per second. Note that the vertical pulses occur at a 60-Hz rate, but that alternate pulses are slightly different, due to the interlacing.

For our purposes, the main point to remember is that those horizontal and vertical pulses, and the color-burst signal, are used for timing and synchronization necessary to reconstruct the TV picture. If any of those pulses are absent, distorted, or altered, it becomes difficult or impossible to synchronize the TV picture. It will roll, tear, and the colors will be incorrect, rendering the picture unwatchable. Naturally, the video level must not be so great as to exceed the horizontal-sine pulse level, otherwise the level-sensitive sync circuits will be "confused" and the TV picture will not synchronize properly.

Audio information is frequency modulated on a 4.5-MHz signal that is added to the composite-video signal; the audio may also be modulated on a subcarrier, as is often done in scrambling systems (more on that in a moment). The audio signal is like a standard FM-broadcast signal, except the deviation is limited to ±25 kHz instead of the ±75 kHz used in FM broadcasting. The audio circuitry in a TV receiver is much like the corresponding circuitry in an FM broadcast receiver.

The color signal is a bit more complex to understand, but basically it is a 3.58-MHz (actually, 3.579545-MHz) signal that is both amplitude and phase modulated. The amplitude of that signal determines the saturation of a color, (whether it is, for example, white, light pink, rose, or red) and the phase determines the hue (whether it is red, orange, yellow, etc.). Note that the amplitude of the composite color signal is used to determine the difference from white, not the intensity, of a particular color. In that way, a color signal with zero level would produce a white raster making for compatibility between color and black-and-white reception on the same TV receiver.

Of course, we have only touched upon the basics of the video signal. Since a

comprehensive treatment of the subject would take much more room than we have available, we suggest you consult a good reference on the topic. You are sure to find several at your local library or technical book store.

Scrambling the picture

As you may have guessed from the foregoing, by altering any of the key components that we've discussed, a picture can be rendered unwatchable. If the alteration is done in such a way that a circuit at the receiving end can counteract such alteration, you have the basis for a scrambling system.

Further, there are still more ways in which a signal can be scrambled. For instance, the video information between the sync pulses may be modified, the scanning sequence can be altered, or various scrambling techniques can be integrated in a time varying way to provide different scrambling by minute, second, or even frame.

Several simple scrambling schemes are generally in wide use today on cable and pay-TV systems. One of the simplest in use is video inversion. In that method, the video information is sent with reversed polarity. The TV may or may not sync on it (depending whether the sync pulses are inverted also). If the set can synchronize the signal, it appears as a negative picture—dark areas are light, and highlights are dark. Colors are reversed, and appear as complementary to those in the original scene. If you do not mind watching blue faces, brown skies, and red grass, then the picture might be watchable.

Usually nothing is done to the sound, although it may be modulated onto an subcarrier, and the main sound carrier may have what is called "barker audio" on it (more on that in a moment).

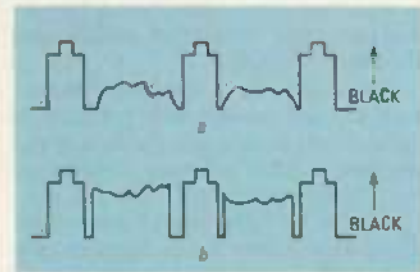

FIG. 1—A NORMAL NTSC video signal is shown in a. In one of the simplest scrambling methods, the polarity of the video information, which is located between the horizontal blanking pulses, is inverted, as shown in b.

Inverted video is easily unscrambled by merely re-inverting the video polarity in a video amplifier. That can easily be done in the TV set. The only precaution is that it must be done at a suitable point in the video system. For example, if the sync pulses are not inverted, it must be done after sync takeoff. Some sets use separate detectors for sound/sync takeoff. Figure

1-a shows what a video signal with inverted video, but normal sync pulses, looks like.

A more sophisticated method is to invert the video at several intervals during the frame, or every several frames, or during positions of scan lines. That results in a picture with a very annoying flicker or a superimposed pattern, which would be unwatchable unless you don't mind severe eyestrain or a headache. Figure 2 shows what a video signal that has been scrambled in that way looks like. Decod-



FIG. 2—IN SOME SCRAMBLING SYSTEMS the polarity of the video alternates every frame or every few frames.

ing that signal requires an arrangement where the video polarity can be instantaneously changed in synchronization with the scrambling signal. A block diagram of an appropriate decoding system is shown in Fig. 3. The information required by the decoder to sync with the scrambled signal can be transmitted on the sound carrier, sent with the picture itself, or obtained from the sync section of the TV set.

If alternate frames are inverted, the eye would tend to add the adjacent frames due to persistence of vision. That would show up as either a weak positive or negative image, or ideally, a blank raster. However, the video inversion method and its more sophisticated versions are not very "secure" in the sense that descrambling is easily done. Video inversion is best used along with a more complex method that also acts on the sync pulses.

Scrambling the sync

There are many ways to alter the sync pulses. One method that is currently popular is called sine wave scrambling. In that method a 15.75-kHz sine wave is added to the video signal. If the negative peak of the sine wave corresponds to the positive peak of the sync pulse (see Fig 4), that suppresses the sync signal below the peak video level. That "confuses" the sync separator circuits in the TV set and they cease to function properly.

The resulting picture tears and rolls, and has a vertical dark band. Colors are lost or out of sync, since the TV set cannot tell where the sync pulse is. Some video signals that have mostly very light areas (highlights) may synchronize properly for a moment, but most will roll, tear, or distort. The picture is generally unstable and cannot be watched.

Unscrambling is done by taking the scrambled signal and mixing it with a sine wave of proper phase and amplitude to cancel the added sine wave. The sine wave

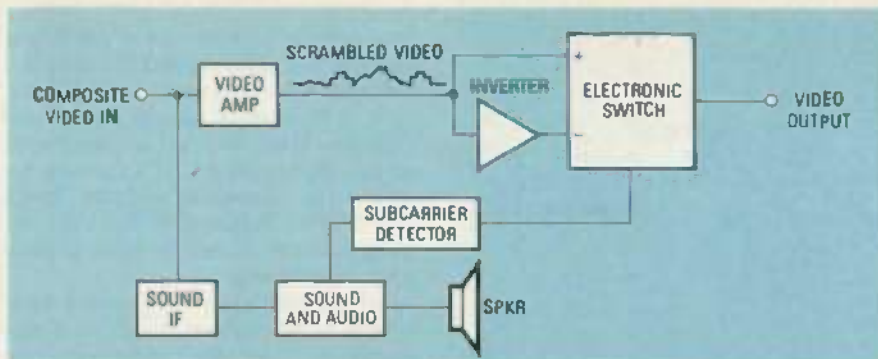

FIG. 3—THIS BLOCK DIAGRAM shows a circuit that can be used to descramble a signal in which the polarity of the video information is randomly switched.

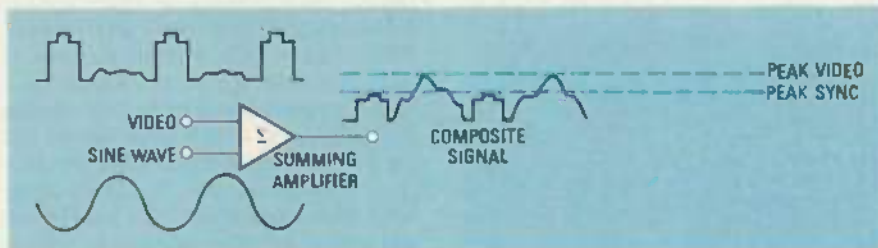

FIG. 4—IN SINEWAVE SCRAMBLING the video information is summed with a sine wave. The result is that the normal relationship between the peak sync and the peak video is altered.

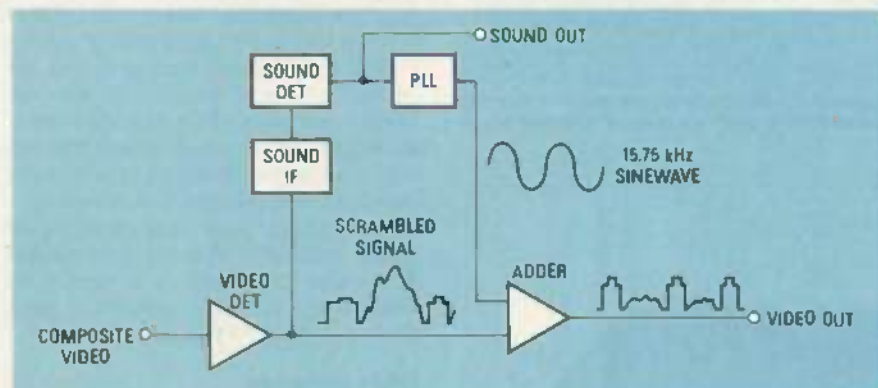

FIG. 5—IN A SINEWAVE DESCRAMBLER, a 15.75-kHz sine wave is summed with the scrambled signal to yield a normal video signal.

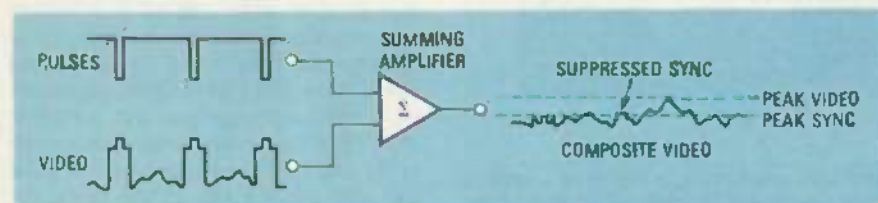

FIG. 6—IN GATED-SYNC SCRAMBLING, a negative pulse train is summed with the composite video to yield a video signal in which the amplitude of the horizontal sync pulses is greatly attenuated. That makes it impossible for a TV set to lock onto the signal.

is usually obtained from a PLL that is locked to a 15.75 KHz signal encoded on the audio signal. That operates very much like a PLL used for stereo FM pilot-carrier regeneration. In fact, the circuitry is very similar and FM stereo IC's can be used to good advantage in a descrambler circuit. A block diagram of an appropriate descrambler circuit is shown in Fig. 5.

Figure 6 shows another method of suppressing the sync. Called gated-sync scrambling, that method is similar to sine-wave scrambling in that it operates by altering the relationship of the amplitudes

of the sync pulses and the video signal. That is done by summing a negative pulse train with the composite video signal. The result is a composite video signal in which the sync pulses appear to be missing. As a result, the sync circuitry, which generally picks out the most positive signal levels and assumes they are sync pulses, is rendered inoperative and the picture tears and rolls.

To descramble a gated-sync signal, a pulse train of proper amplitude and phase is summed with the altered composite video signal. A block diagram of a de-

scrambler that does that is shown in Fig. 7. The pulse train is generated in the descrambler and is usually locked to the signal from the the decoder PLL circuit via the same technique that's used in a sine wave decoder. In fact, the gated-sync method of scrambling is very similar in theory to the sine wave method, and it is possible to design one descrambler that could be made to decode both of those types of scrambling.

Audio scrambling

A word about audio scrambling: The audio carrier is located 4.5 MHz from the picture carrier. It is a distinct frequency component of the TV signal and can be received on an FM receiver tuned to the appropriate frequency. The signal is identical to standard (broadcast) FM, except that the deviation is limited to ± 25 kHz.

The TV-audio signal can be modulated with subcarriers. Normally a TV receiver has a quadrature or discriminator type detector, with an RC filter on the audio output. As to the IF bandwidth, a rule of thumb in FM receivers is that it is twice the deviation plus the highest modulation frequency. Since TV audio normally goes up to about 10-15 kHz, the bandwidth of the audio IF would be about 2×25 kHz, plus 10 to 15 kHz, or about 60-65 kHz. In most TV receivers, the audio-IF bandwidth is about 100 kHz.

If the 4.5-MHz carrier deviation is reduced somewhat, subcarriers can be put into the audio channel up to about 100 kHz or so. They can serve as subcarriers for decoding signals, or even other audio channels. An example of that is the (L-R) audio channel in an FM stereo system, whereby the differences between the left and right channels are encoded on a 38-kHz subcarrier.

In many scrambling schemes, the program audio is stripped away and placed on an audio subcarrier that is some multiple of the horizontal scan frequency. The most common and practical audio subcarrier frequency is 31.5 kHz; the 15.75-kHz horizontal-scan signal is used as the pilot carrier. Those frequencies are close enough to the 19-kHz pilot frequency and 38-kHz subcarrier frequency used in FM stereo to allow the use of mass-produced FM-stereo IC's in TV audio decoders.

If the audio is stripped away in that manner, a viewer without a decoder will receive no sound and a scrambled picture. In many scrambling systems, rather than being empty, the main audio channel can be used as a "barker channel" for advertising for the pay-TV service, music, or anything at all. A block diagram of a circuit that can be used to encode an audio signal in the above manner is shown in Fig. 8.

Note that stripping away the program audio and placing it on a subcarrier is not really scrambling. It is merely relocating

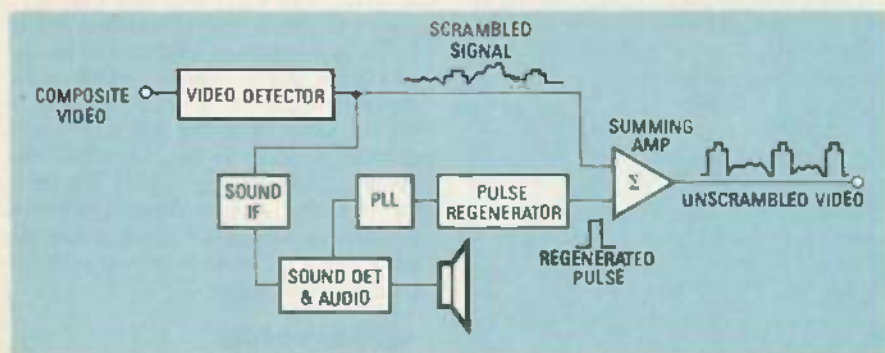

FIG. 7—A GATED-SYNC DESCRAMBLER is very similar to one used to descramble sinewave-encoded video. In fact, it is possible to design a single decoder to descramble both systems.

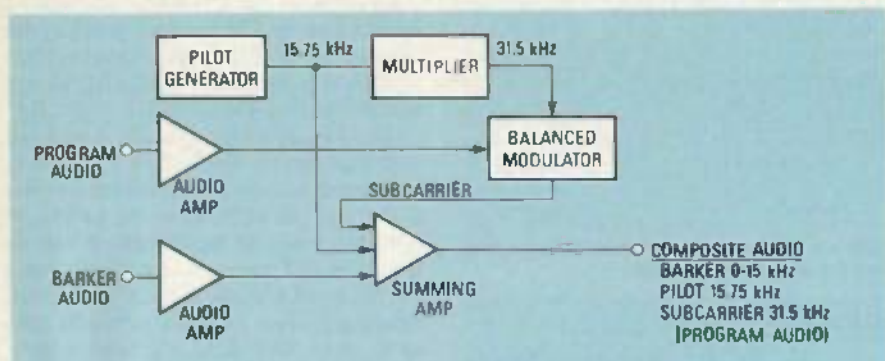
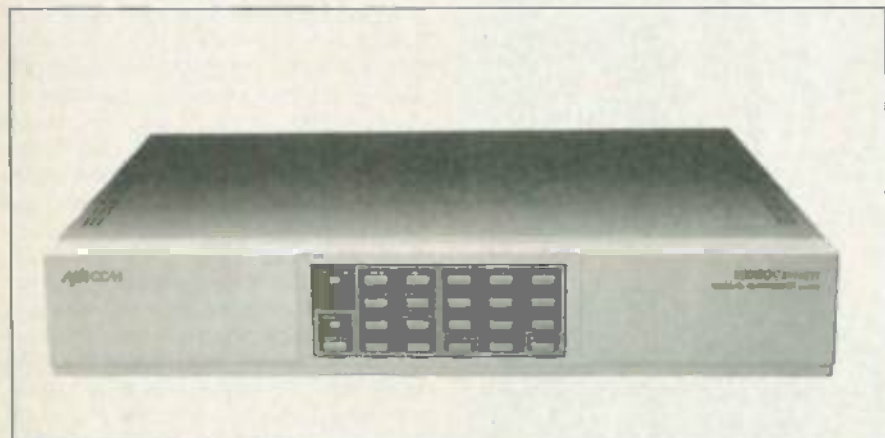

FIG. 8—IN MANY SCRAMBLING SYSTEMS, the program audio is stripped away and put on a 31.5-kHz subcarrier. Where that's done, usually the normal audio channel is used as a "barker" channel, which contains advertising, music, etc.



SCRAMBLING FROM THE SKIES. This M/A-COM Videocipher descrambler is the key to unlocking HBO's (and other's) satellite programming. In a future installment we'll be looking at the Videocipher system.

the audio program in such a way that it can not be received on a standard TV set. True audio scrambling would involve altering the audio waveform. If that were done, the signal might be receivable on a standard TV set, but it would be unintelligible under any circumstances. True scrambling can be done using any one of a number of techniques, including frequency inversion and digitizing. However, care must be taken to ensure that the encryption technique does not restrict the useable audio bandwidth.

Cable-TV scrambling

The box-type descrambler commonly

used in CATV systems generally contains an RF converter to convert all cable channels to one fixed channel, usually Channel 3 or 4. By doing that, the descrambler circuits can be designed to deal with but a single channel.

In the case of sinewave or gated-sync descramblers, some actually detect the video signal, extract necessary decoding signals from it, and use those signals to act upon the channel 3 or 4 IF signals. By using a variable-gain IF amplifier for channel 3 or 4, the decoding signals can modulate the IF gain, reestablishing proper sync-signal level and cancelling the sinewave modulation, or reestablishing

sync-pulse level in the case of gated-sync systems. The encoding and decoding signals may also be supplied in CATV systems at frequencies outside the receiver channels. Many different encoding techniques can be used in CATV systems, but gated sync, sinewave, and the Zenith SSAVI (Sync Suppression And Video Inversion) seem to be the most popular schemes currently.

Another method used on some cable systems is the deliberate insertion of keyed carriers in the video channel used for premium TV shows. An RF carrier can cause severe crosshatching. Keying the carrier causes an annoying flicker, and the resultant picture looks like a severe case of TVI caused by a CB or amateur station. In order to provide service to a subscriber, a high-Q trap is inserted in the transmission line between the CATV signal tap-off and the TV set. That method, while inexpensive, is easy to defeat. A high-Q cavity notch filter can be made out of a coffee can and several feet of 1/8-inch copper tubing. Those materials can be used to construct a helical resonator; tuning the resonator is merely a matter of adjusting its cavity for a notch at the interfering frequency. Also, a high-Q stub transmission line section can be used to achieve the same purpose. We have known cases where even a few feet of aluminum foil wrapped around the outside of a length of 300-ohm twin lead (the aluminum foil position is adjusted for a null) did a fairly good job of rendering the picture watchable. However, note that that is not true scrambling; it is merely the addition of deliberate, controlled interference to the CATV signal.

Odds and ends

There are several ways we could modify the systems that we've discussed thus far to make them more difficult to decode by non-authorized viewers. For instance, in the sinewave scrambling method, rather than using a 15.75-kHz signal, the scrambling sinewave could have a frequency of 31.5. If that were done, every other cycle of the sinewave would cancel a sync pulse and the picture would be vertically streaked twice instead of once.

Similarly, the gated-sync system could be made more difficult to decode by substituting a more complex pulse waveform for the one we illustrated.

Next time

Thus far, the scrambling techniques we've discussed are relatively simple. Consider, however a system in which the method of scrambling varies with time, or one in which digital techniques are used to alter the sequence in which the video information is transmitted, or both. Thanks to today's low-cost digital IC's such sophisticated scrambling techniques are now possible and practical. We'll look at some of those techniques next time. R-E



Versatile Bench Top Power Supply

*Here's a high-performance power supply
to help get your designs off of the drawing board and on to a PC board!*

GREG SWAIN AND FRANCO UBAUDI*

EVERYONE WHO WORKS WITH ELECTRONICS needs a power supply, but a commercially-produced variable-voltage current-limited power supply can take quite a chunk out of your pocketbook. So we decided to find a better way. Our power supply provides any voltage between 3 and 30 volts, at any maximum current you desire less than 1000 mA. In addition, our supply provides short-circuit protection, load switching, and switchable voltage/current metering. Further, all parts are readily obtainable and inexpensive, and the supply is easy to build and calibrate.

One feature that really sets our design apart is that it's capable of providing a full amp of power over most of its range of output voltage. Many comparable power supplies can provide one amp of current, but only over a restricted range of output voltage.

Output voltage is selected by means of a range switch with two positions: 3-15 and 15-30 volts. A potentiometer varies voltage continuously throughout the selected range. Similarly, current limiting is selected by a switch providing ranges of 150-400 and 400-1000 ma, and by a potentiometer that allows current to be varied continuously over the selected range. Actually, both current and voltage ranges overlap slightly to ensure that there are no gaps in output.

*Adapted with permission of *Electronics Australia*

The graph in Fig. 1 illustrates the high performance you can obtain from our power supply. As you can see, maximum load current (one amp) is maintained up to 27 volts, after which the load curve falls away due to transformer losses. Other specifications include load regulation that is better than 0.2% from zero to full load, and output ripple that is less than 2-mv rms.

Design considerations

Initially we considered using an LM317 three-terminal variable-voltage regulator as the basis for our supply, but we soon ran into difficulties. Despite various ap-

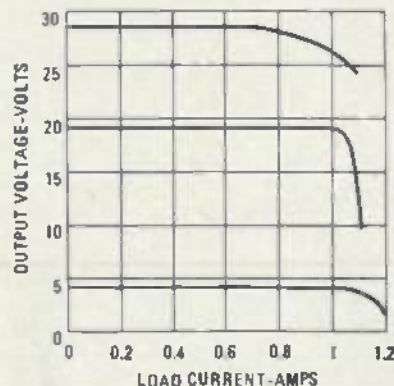

FIG. 1—POWER SUPPLY CAN SUPPLY ONE amp of current all the way to 27 volts, where output drops to about 0.75 amp.

proaches, we were unable to come up with a cost-effective circuit that would deliver one amp over the entire voltage range. The problem was thermal limiting in the LM317 with a high input voltage and a low output voltage. Another drawback was that an additional op amp was required to provide current sensing for the current-limiting circuitry, and that would have increased both cost and complexity of the circuit.

So we rejected the LM317 and adopted the LM723. It requires a current-boasting transistor, but it has built-in current limiting. The guts of the 723 are shown in Fig. 2. It consists of a series-pass transistor, an error amplifier and a voltage reference. The error amplifier compares a portion of the output voltage with the internal reference voltage and continually regulates the base current that is applied to the series-pass transistor. That's what provides regulated output.

The 723's built-in series-pass transistor can deliver a maximum of 150 mA of current, so, in order to obtain more current, an external power transistor is required.

One particularly useful characteristic of the 723 is its built-in current-limiting circuitry. When output current reaches a preset value, the current-limit transistor turns on and that reduces the base drive to the series-pass transistor. The output voltage is thereby reduced.

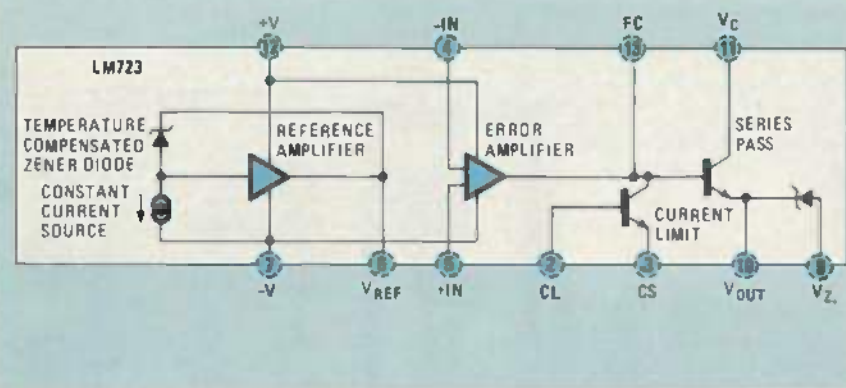

FIG. 2—THE LM723 REGULATOR has most of the circuitry necessary for a complete current-limited power supply built right in.

Circuit details

The schematic of the complete power supply is shown in Fig. 3. A tapped transformer drives a diode bridge (D1–D4) and two 2500- μ F filter capacitors (C1 and C2). That provides a no-load voltage of 37 or 47 volts, depending upon the position of switch S2-a. The unregulated DC is then fed to a pre-regulator stage composed of Q1 and D5. Those components protect IC1 (the 723) from an over-voltage condition; the 723 can't handle more than 40 volts.

The LED (LED1) and its 2.2K current-limiting resistor (R1) provide on/off indication. The current through the LED varies slightly according to the transformer tap selected, but that's of no real consequence.

The series-pass transistor in IC1 drives voltage-follower Q2, which provides cur-

rent amplification. That transistor can handle lots of power. It has a maximum collector current of 15 amps and a maximum V_{CE} of 70V, both of which are more than adequate for our supply.

Heat dissipation could have been a problem when drawing high current at low voltage. We solved that problem by switching the secondary winding of the transformer. For outputs greater than 15 volts, S2-a selects the 30-volt tap on the transformer, and for outputs less than 15 volts, S2-a selects the 24-volt tap.

Voltage regulation

Now let's examine in detail how the voltage-regulator section works. The error amplifier in the 723 is connected as a non-inverting amplifier with variable gain. The input to that amplifier is fixed at about 2.8 volts by R3 and R4, which are

fed by the 723's internal reference voltage. Capacitor C3 is included to reduce output noise.

On the 0–15V range, switch S2-b is closed, so feedback resistance—the resistance between the output of the supply and the inverting input of the error amplifier—can be varied between 100 and 5000 ohms. That corresponds to an amplifier gain ranging from 1.1 to 6.1, and that corresponds to an output voltage ranging from 3.1 to 17.1 volts. With switch S2-b open, the gain of the amplifier is adjustable from 5.8 to 10.8, and that corresponds to an output voltage ranging from 16.2 to 30.2 volts.

The current-limiting circuit depends on the position of S3. That switch causes load current from the emitter of Q2 to flow through either R14 or R15. The resulting voltage is applied to a voltage divider network composed of R12 and R13. The voltage developed at the junction of those two resistors depends on the setting of front-panel control R13, CURRENT LIMIT. That voltage is then applied to the current-limiting transistor in the 723.

In the interests of economy, we elected to use a single meter and to switch between measuring voltage and current. It would be nice to have a separate meter for each, but cost is prohibitive. Meters are expensive, and a larger case, which is also more expensive, would be necessary to provide the necessary front panel area.

Our metering circuit is straightforward. When measuring voltage, the parallel combination of a R16 and R17 provides an effective resistance of 30K. That resistance is in series with the one-mA moving-coil meter, so it can measure a maximum of 30 volts full scale. When measuring current, the meter is shunted by the 0.5 ohm resistance provided by the parallel combination of R5 and R6. Trimmer potentiometer R7 is used to adjust the meter for accurate readings.

There's not much else to the circuit. Capacitor C6 prevents switching transients from being delivered to the output, and D6 protects the power supply from an accidentally-applied reverse voltage—from a charged capacitor, for example. Capacitor C5 ensures stability of the supply under all conditions.

Construction

Except for the front-panel switches, potentiometers, etc., and the power transformer, all components are mounted on a PC board that measures about 4 1/4 x 4 3/4 (inches). A foil pattern for the board is shown in "PC Service."

No special procedure need be followed when assembling the PC board, although the job will be much easier if the lower-profile components are installed first. Refer to the parts layout in Fig. 4 to install all components; be careful to install IC1, the diodes, the transistors, and the elec-

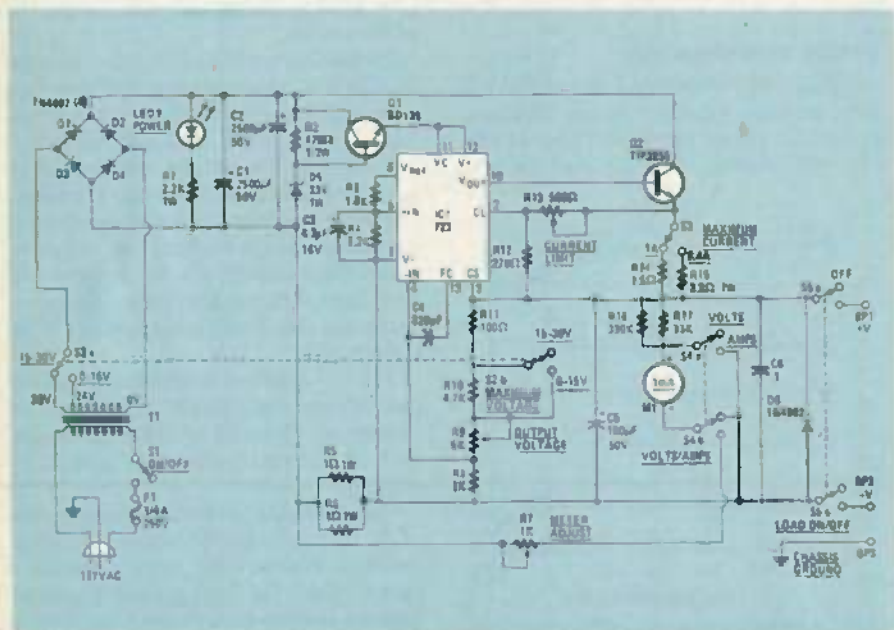

FIG. 3—SCHEMATIC DIAGRAM OF OUR POWER SUPPLY shows how the LM723 can be put to good use with little more than a current-amplifying transistor (Q2).

trolytic capacitors in the correct orientation. Also, mount transistors Q1 and Q2 without trimming their legs; the full length will be necessary if you use the heat sink arrangement shown in Fig. 5.

The power supply is housed in an attractive plastic instrument case that measures about 7 1/4 x 6 1/4 x 2 1/4 (inches). If you purchase the kit from the source mentioned in the parts list, you'll receive special front and rear panels.

The layout of the front panel is shown in

PARTS LIST

All resistors 1/4-watt, 5% unless otherwise noted.

- R1—2200 ohms, 1/2 watt
- R2—470 ohms, 1/2 watt
- R3—1800 ohms
- R4—1200 ohms
- R5, R6—1 ohms, 1 watt
- R7—1000 ohms, trimmer potentiometer
- R8—1000 ohms
- R9—5000 ohms, panel-mount potentiometer
- R10—4700 ohms
- R11—100 ohms
- R12—270 ohms
- R13—500 ohms, panel-mount potentiometer
- R14—1.5 ohms, 5 watts
- R15—3.9 ohms, 1 watt
- R16—330,000 ohms
- R17—33,000 ohms

Capacitors

- C1, C2—2500 μ F, 50 volts, electrolytic
- C3—4.7 μ F, 16 volts, electrolytic
- C4—820 pf, ceramic disc
- C5—100 μ F, 50 volts, electrolytic
- C6—0.1 μ F, ceramic disc

Semiconductors

- IC1—LM723 voltage regulator
- D1—D4, D6—1N4002 rectifier
- D5—1N5257B, 33 volts, 1 watt, Zener diode

- Q1—BD139 or ECG373
- Q2—TIP3055

Other components

- F1—1/4-amp, 250-volt fuse
- M1—0-1 mA panel meter
- S1—SPST power switch
- S2, S4—DPDT switch
- S3—SPDT
- S5—DPST
- T1—117 VAC primary, 0-24-30 volt secondary, 1 amp (Aitronic A6672)

Miscellaneous

Line cord, heatsink, mica insulators, silicone grease, PC board, case, binding posts, knobs, solder, wire, etc.

Note: A complete kit of parts, including case, is available for \$49.95 from Imtronics Industries, Ltd., 11930 31st Court, St. Petersburg, FL 33702. Florida residents must add appropriate sales tax.

Fig. 6. Note that, if you use a different meter than the one specified in the Parts List, you'll have to alter the drilling dimensions accordingly. The kit includes *Scorchal* artwork that you can affix to the front panel and then spray with a hard-

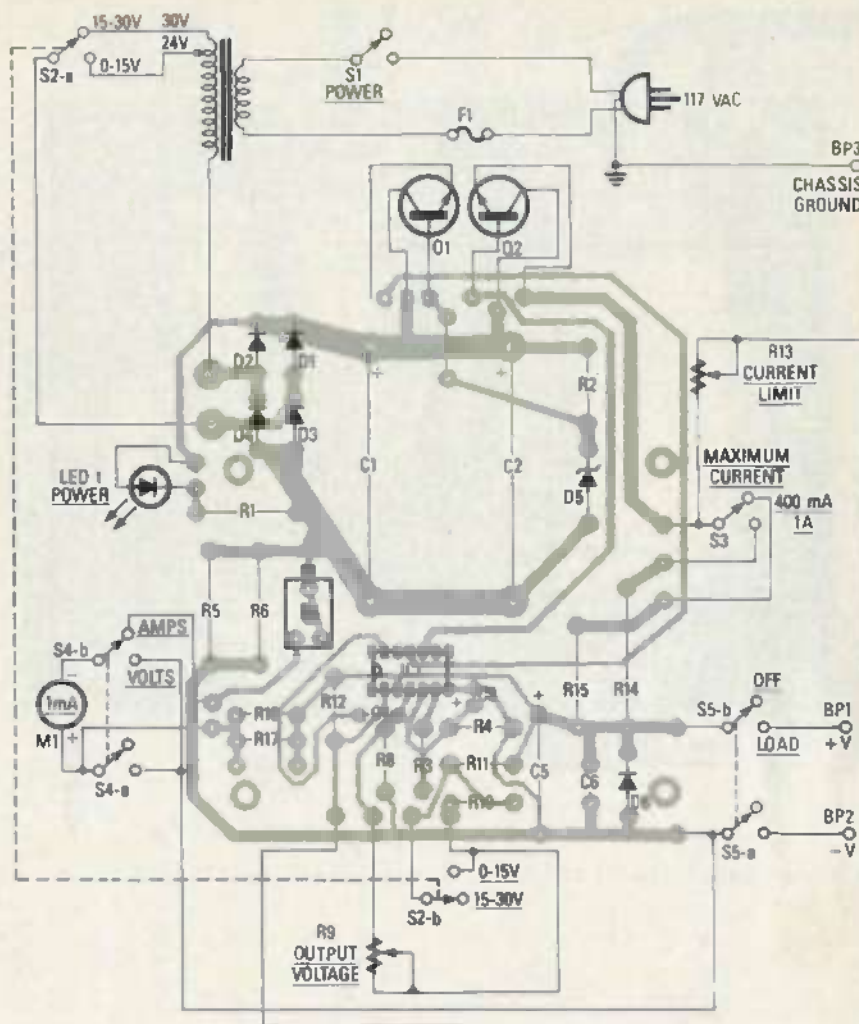

FIG. 4—ON- AND OFF-BOARD COMPONENTS are mounted and wired as shown here.

setting clear lacquer to protect the artwork, which can then be used as a template.

You'll also have to drill holes in the rear panel for the fuse holder, the power cord, and the heatsink. But, don't drill the heatsink holes yet.

Secure the PC board to four internal mounting posts using self-tapping screws, and bolt the power transformer to the case using machine screws and nuts. Include a solder lug under the nut nearest the rear panel.

Use medium-duty hookup wire (16 gauge) for all wiring that carries the full supply current, and light-duty hookup wire for the potentiometer, the meter, and the LED.

Install the rear panel and then mark the positions of the holes for the power transistors. Drill those holes, and then you can use the rear panel as a template for drilling the heatsink mounting holes. The heatsink may have to be trimmed to fit the rear panel. Both transistors must be insulated from the rear panel using mica washers and insulating bushings. Smear heatsink grease on all mating surfaces,

including the rear of the heatsink, and then bolt the assembly together using machine screws and nuts as shown in Fig. 7. Finally, use an ohmmeter to make sure that there is no conductivity between the metal tabs of the transistors, and the rear panel, or the heatsink.

Anchor the 117 VAC power cable to the rear panel with a cable clamp. Solder the "hot" 117 VAC lead to the fuseholder, the neutral wire to the power transformer, and the ground-wire to the solder lug beneath the transformer. In addition, separate ground leads should be run to both the rear and the front panels.

We recommend that you use heat-shrink tubing over all 117 VAC connections to the fuseholder, the transformer, and the power switch. That will prevent you from being shocked while doing the testing and calibration discussed below. Use wire with thick insulation for the 117 VAC circuit, and do not use a miniature metallic switch for power switch S1.

Shown in Fig. 8 is a meter scale you can use to replace the scale that comes with the meter. Being careful not to bend the meter's needle, gently pry the plastic

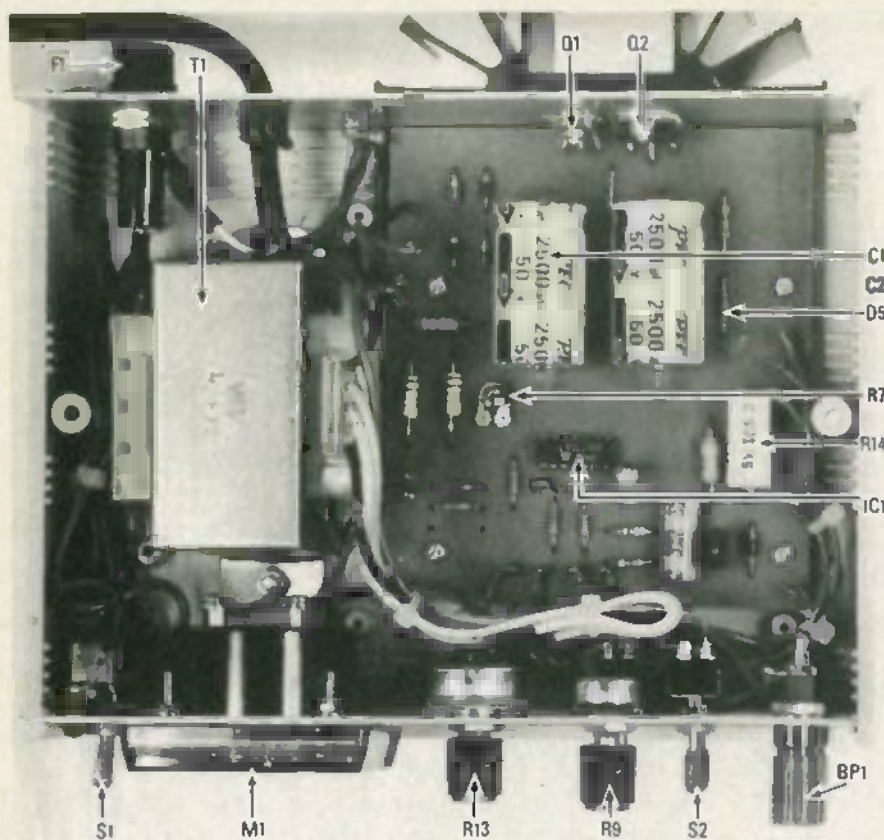

FIG. 5—INTERNAL VIEW OF THE POWER SUPPLY reveals its neat, clean, design.

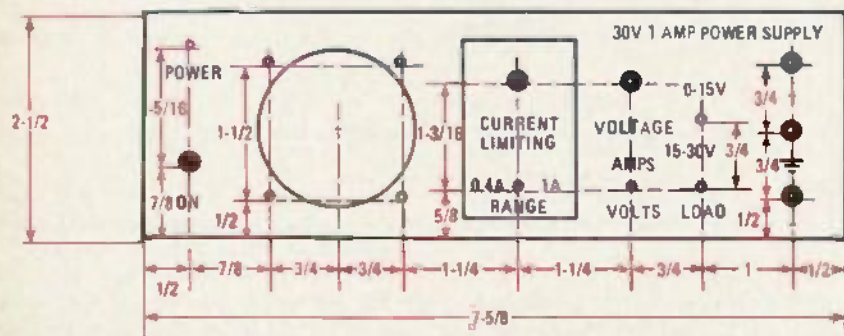

FIG. 6—DRILL THE FRONT PANEL OF THE POWER SUPPLY according to the dimensions shown here.

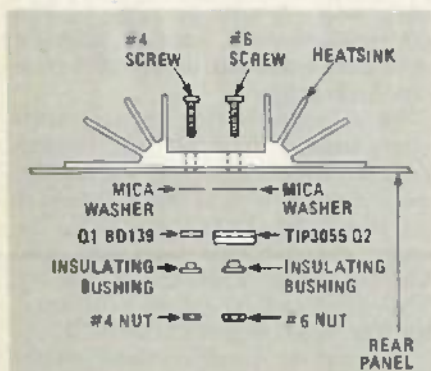

FIG. 7—ATTACH Q1 AND Q2 to the rear panel and the heatsink as shown here. Use heatsink grease on all mating surfaces.



FIG. 8—ENLARGE OR REDUCE THIS METER SCALE to fit the meter you use, and then glue our scale over yours.

valued resistor there to increase the accuracy of the voltage displayed by the meter, if necessary. Just use Ohm's law to calculate the appropriate value.

Assuming all is well, open the load switch, select the 0-15 volt range, and then turn the OUTPUT-VOLTAGE potentiometer fully counter-clockwise. Now set the CURRENT-LIMIT control to the middle of its rotational range, the CURRENT-LIMIT switch to the one amp range, and the VOLTS/AMPS switch to amps. Now connect a one-amp ammeter directly across the output binding posts and close the load switch.

Your meter should indicate a current of about half an amp, although the supply's meter may show something different now. Adjust the CURRENT-LIMIT control so that the multimeter reads 1A, and then adjust trimmer resistor R7 so that the supply's meter reads the same.

Finally, vary the CURRENT-LIMIT control and verify that the meter reading corresponds closely to that on the multimeter throughout its range.

Applications

Why is adjustable current limiting useful? First, it protects the power supply in case its output is inadvertently short-circuited by improper circuitry. Second, it helps prevent that circuitry from being damaged by excessive current due to a fault condition.

Why is a separate LOAD switch useful? It allows you to remove load voltage without turning the supply off. The latter can cause switching transients that might damage the power supply, the circuit under test, or both.

So, when testing out an untried circuit, turn the LOAD switch off, and the voltage and current controls all the way down. Connect the supply to your circuit, turn the LOAD switch on, and gradually increase output voltage to the required voltage. Next set the meter to measure current and turn the CURRENT LIMIT control up slowly while monitoring the meter. If the needle of the meter seems to jump at all throw the LOAD switch quickly. But if the needle moves smoothly as you rotate the control, most likely the circuit has no severe power-related problems. In other words, you're not likely to fry anything! So now you're ready to start the real work—testing and troubleshooting your circuit. But that's another article. R-E

cover off the meter and glue an enlarged copy of our scale over the present one.

Testing and calibration

Connect a voltmeter across the output binding posts, turn the supply on and close the LOAD switch. If all is well, the POWER LED will light up and you will be able to vary the output voltage from three to 30 volts using the RANGE switch and the OUTPUT VOLTAGE CONTROL.

Verify that the voltage reading on the supply's meter and on your meter are identical. Note that we left room on the PC board for an additional trimmer resistor that, if used, would parallel R16 and R17. You can install an additional high-

BUILD THIS

Click and Pop Filter for your STEREO

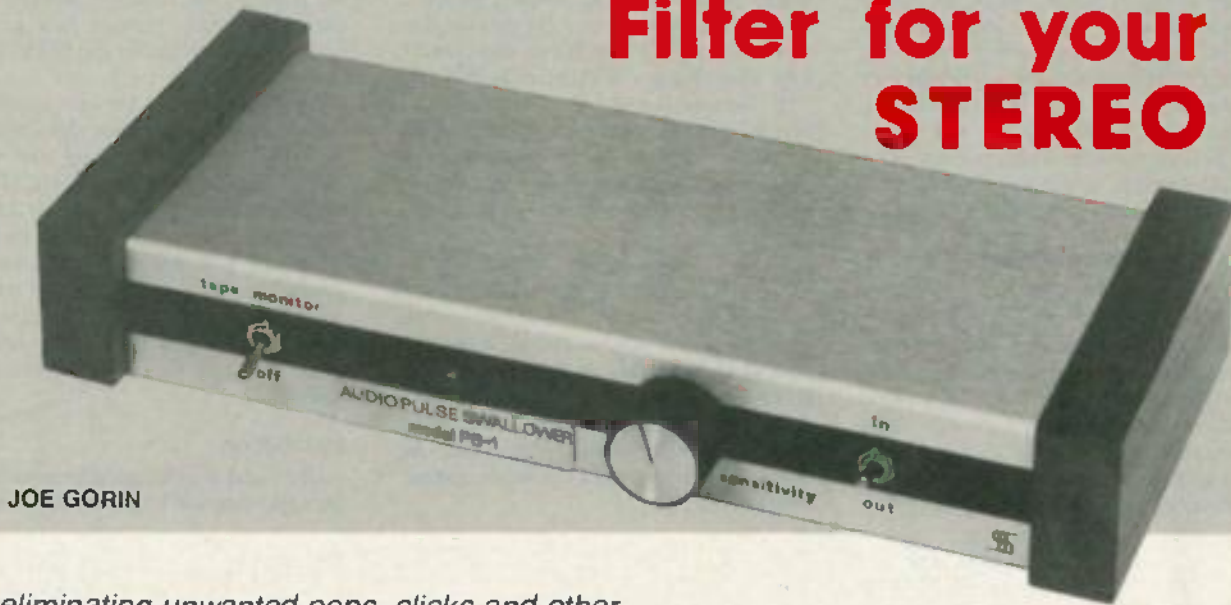

By eliminating unwanted pops, clicks and other surface noise, this inexpensive scratch filter brings you to new heights of audio realism!

Part 2 THIS MONTH, WE'LL show you how to build our click and pop filter. But before we get to that, let's finish up the discussion that we began last time about how the detector circuit works.

Resistors R27-R30 take a statistical sample of variations in level; that sample is detected by IC5-a, which stores short-term peaks on C13 and long-term peaks on C14. The latter is also part of a circuit (including C15 and C16) that prevents transients—either scratches or music—from changing the comparator's threshold too quickly.

Front-panel SENSITIVITY control R45 varies the gain of IC5-b, whose output sets the comparator's threshold higher when the signal warrants it. For example, signals with much high-frequency content—cymbal crashes, for instance—can cause false triggering. But, in general, very large transients tend to be scratches; a large transient will turn on D8 to slow down threshold changing. Diode D10 allows C16 to discharge rapidly if the transient disappears rapidly, as can happen between wide, two-edged scratches (which are quite common).

When the signal exceeds the threshold, the output of IC6-a goes low and shorts to $-V_{CC}$. And that, finally, is what causes the deleter to delete! The deletion is done by "flipping" the analog switches (electronically, of course) to perform the actions described above.

When the transient ends, IC6-a's output floats high, and C20 delays the return from deletion mode by charging slowly through R41. Capacitor C21 functions as a pulse-stretcher; it charges even more slowly than C20, and that allows LED1 to remain lit long enough to be visible, even if the deletion time was short.

Power supply

The power supply, shown in Fig. 8, is important in this circuit, especially during a deletion, because the gain of the deleter is so high. Our primary design goals were low ripple and freedom from interference by magnetic fields. Low ripple is achieved by filtering the critical negative supply

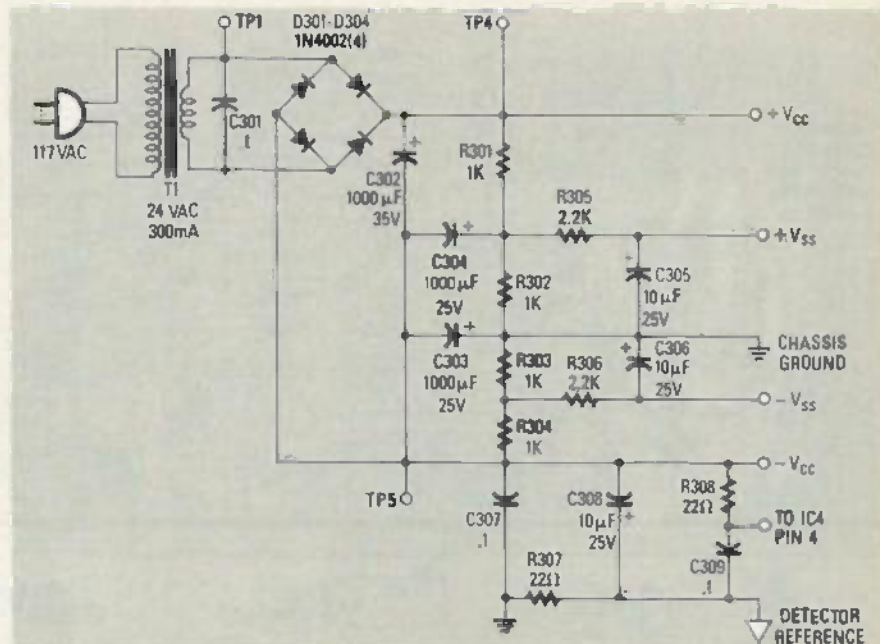

FIG. 8—THE SCRATCH FILTER'S POWER SUPPLY IS SHOWN HERE. Parts are numbered beginning at 300; all components except T1 mount on the PC board. Note the separate detector reference that is derived through R307.

with respect to ground using capacitors C302-C304. Actually, it is the ground that is filtered, not the supply; but the result is the same, except that at low frequencies the ground impedance isn't low.

Magnetic fields are minimized by using a wall-plug transformer and by placing the deleter at the opposite end of the board from the supply. What we get is an inexpensive supply that performs as well as the exotic center-tapped toroidal-transformer supplies often used in high-performance audio equipment. By the way, the $\pm V_{SS}$ supplies are provided to operate the 4016 analog switches, which can't tolerate the ± 15 volts used to power the op-amps.

Input and output circuits

The signal into our Scratch Filter should come after your amplifier's phono preamp via the TAPE OUT jacks that are normally used to connect a tape recorder. Most signal processors (such as graphic equalizers) replace those TAPE OUT jacks by connecting the processor's input jacks in parallel with a new TAPE OUT jack. In our case, we chose to locate the TAPE OUT

jack, and the TAPE MONITOR switch after our processor, so that you can tape record albums with the full benefit of our Scratch Filter.

Construction

Due to the critical nature of the deleter's layout-matching requirements, a PC board is necessary to get good performance from this Filter. If you want to etch your own board, a foil pattern is shown in "PC Service;" you can also purchase a board from the source mentioned in the Parts List. Refer to the component-placement diagram in Fig. 9 and the chassis photo in Fig. 10 during the following discussion.

Begin construction by inserting the resistors. You can bend the leads of most resistors as necessary, but the following resistors in the deleter circuit should be bent as shown in the photo: R114, R222, R215, R216.

Next insert the capacitors, followed by the diodes, and then the transistors. Be careful to get the polarity of those components correct.

Next you can install the IC's. As mentioned above, you must cut off pin 5 of IC4. If you use a metal-can version of that IC, the tab is by pin 8. Be sure to insert that IC—and all the others—correctly. Connect short lengths of wire for the panel-mounted components to the appropriate pads on the board. Carefully check over your work, remove flux from the board, and then install the board in your enclosure.

The chassis used for our prototype is built from a thin piece of aluminum bent in a "U" shape. We used two stained pieces of wood for endpanels. The endpanels are attractive, and they keep the aluminum from scratching the surface of whatever you set the Filter on. The printed-circuit board should be mounted close to the sheet metal so that the circuitry will be shielded from electromagnetic fields that may be radiated from nearby equipment.

Installation

The Scratch Filter must be connected in the tape-monitor loop of your amplifier.

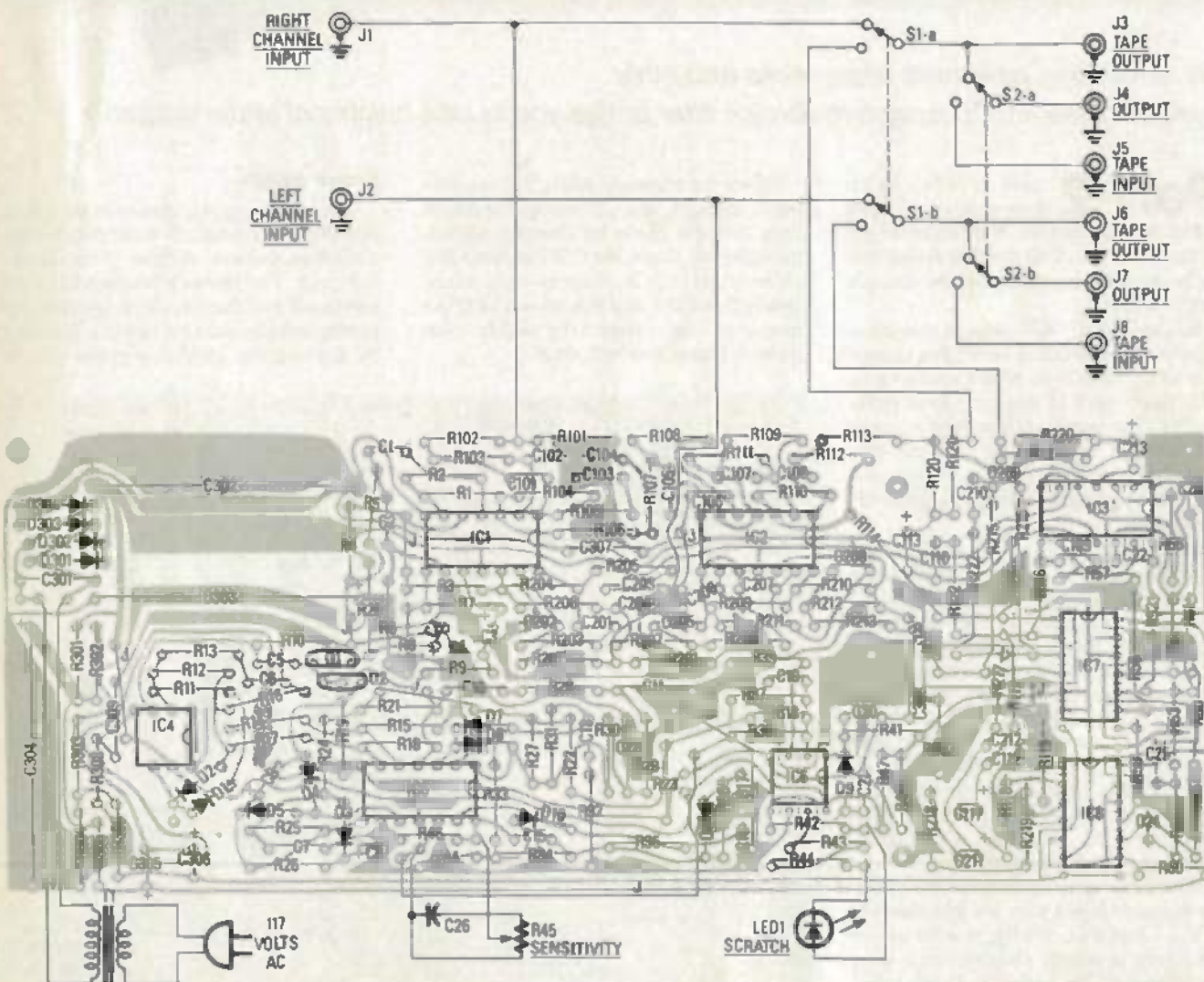

FIG. 9—STUFF THE PC BOARD and wire the front-panel components as shown here. Resistors R114, R222, R215, R216 must be bent as shown in Fig. 10.

PARTS LIST

All resistors 1/4-watt, 5% unless noted.
 R1-R4, R11, R12, R26, R54, R102, R103, R118, R202, R203, R218—22,000 ohms
 R5, R107, R207—2400 ohms
 R6—7500 ohms
 R7, R24—4700 ohms
 R8, R9, R14, R43, R44, R50, R51, R114, R115, R214, R215, R301-R304—1000 ohms
 R10, R34, R35—150,000 ohms
 R13—150 ohms
 R15—1200 ohms
 R16, R39, R56, R104, R204, R305, R306—2200 ohms
 R17, R18, R25, R29, R30, R37, R38—10,000 ohms
 R19—4.7 megohms
 R20, R57, R59, R121, R221—560 ohms
 R21—470 ohms
 R22, R106, R206—1800 ohms
 R23—68,000 ohms
 R27, R60—180,000 ohms
 R28—3300 ohms
 R31—330,000 ohms
 R32—220 ohms
 R33—15,000 ohms
 R36—470,000 ohms
 R40, R49, R62-R100, R123-R200, R223-R300—not used
 R41, R46—39,000 ohms
 R42—22 megohms
 R45—100,000 ohms, linear potentiometer
 R47, R101, R201—100,000 ohms
 R48, R61, R122, R222—270,000 ohms
 R52, R116, R216—36,000 ohms

R53, R58, R111, R117, R211, R217—6200 ohms
 R55, R119, R219—91,000 ohms
 R105, R205—100 ohms
 R108, R208—2700 ohms
 R109, R209—3000 ohms
 R110, R210—12,000 ohms
 R112, R120, R212, R220—33,000 ohms
 R113, R213—8200 ohms
 R307, R308—22 ohms
Capacitors
 C1, C15, C16—0.0033 μ F, 10%, polyester film
 C2, C5, C20, C22, C107-C109, C207-C209—0.001 μ F, 10%, polyester film
 C3, C4, C8, C24, C111, C113, C211, C213, C305, C306, C308—10 μ F, 25 volts, aluminum electrolytic
 C6, C7, C14, C18, C103, C203—0.033 μ F, 10%, polyester film
 C9—3.3 μ F, 35 volts, aluminum electrolytic
 C10-C12, C301—0.1 μ F, 10%, polyester film
 C13, C17, C23, C25, C26, C110, C112, C210, C212—0.01 μ F, 10%, polyester film
 C19, C21—680 pF, 10%, ceramic disc
 C27—see text
 C28-C100, C114-C200, C214-C300—not used
 C101, C201—330 pF, 10%, ceramic disc
 C102, C106, C202, C206—220 pF, 10%, ceramic disc
 C104, C204—0.0047 μ F, 10%, polyester film

C105, C205—0.022 μ F, 10%, polyester film
 C302—1000 μ F, 35 volts, aluminum electrolytic
 C303, C304—1000 μ F, 25 volts, aluminum electrolytic
 C307, C309—0.1 μ F, ceramic disc
Semiconductors
 IC1-IC3, IC5—RC4136, quad op-amp
 IC4—LM301A, op-amp
 IC6—LM393, op-amp
 IC7, IC8—4016, quad analog switch
 Q1, Q2—2N3904, NPN transistor
 D1-D10—1N4148, switching diode
 D301-D304—1N4002, power diode
 LED1—standard LED
Other components
 J1-J8—RCA Phono Jacks
 S1, S2—DPDT toggle Switch

Note—The following parts are available from Symmetric Sound Systems, Inc., 856 Lynn Rose Ct., Santa Rosa, CA 95404, (707) 546-3895: Complete Kit (No. PS-1) \$79.95; PC Board (No. PS-1PC) \$12.00; All semiconductors (No. PS-1SC) \$13.00; All resistors and capacitors (No. PS-1RC) \$16.00; Transformer (No. PS-1XF) \$7.50; Chassis, endpanels, switches, hardware, jacks and instructions (No. PS-1ETC) \$42.50. Free UPS shipping in U.S. with check; MasterCard and Visa orders must add shipping. PS-1SC, PS-1RC and PS-1ETC will not be available after January 31, 1987. California residents must add appropriate sales tax.

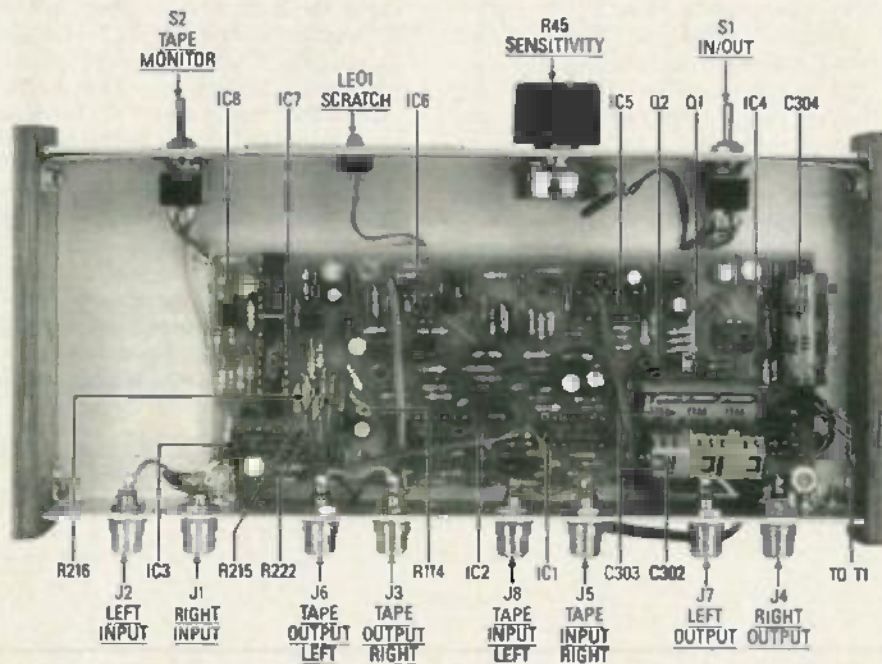

FIG. 10—THE CHASSIS IS BENT from a thin piece of aluminum; small wood blocks are attached to the ends with angle brackets.

In other words, the Scratch Filter's inputs must be connected to your amplifier's TAPE OUT jacks, and the Scratch Filter's

outputs must be connected to your amplifier's TAPE IN jacks. Your amplifier's TAPE MONITOR switch must then be thrown to

the ON or TAPE position.

That wiring scheme routes all signals from your amp's preamp output through the Scratch Filter, and then back to your amplifier. A tape recorder, or any other equipment that used to be connected to your amplifier's jacks should now be connected to the corresponding jacks on the Scratch Filter.

Operation

You can use the IN/OUT switch to switch the Scratch Filter in and out of your audio loop for testing and evaluating. Once you hear the dramatic improvement the Filter provides, you'll probably leave it "in circuit" permanently. The TAPE MONITOR switch on the Filter works just as the one on your amplifier used to.

Initially the SENSITIVITY control should be set to the middle of its range. Due to the wide dynamic range of the ALC circuit you may never need to change the setting of that control. However, for very scratchy records, you may want to turn up the sensitivity. You risk making deletions audible, but by careful adjustment, you can achieve a good balance between scratch noise and deletion errors.

Conclusions

There are many ways to improve the *continued on page 90*

WORKING WITH VOLTAGE COMPARATORS

Voltage-comparators and window-comparators are extremely versatile circuits. Here are some practical circuits that you can put to use.

RAY MARSTON

WE'RE SURE THAT YOU CAN THINK OF many applications for a voltage comparator: a circuit that abruptly changes its output state when an input voltage crosses a certain reference value. Voltage comparators have plenty of practical applications apart from the obvious ones of over- and under-voltage switches. The number of applications becomes especially apparent when you realize that the voltage can be representing resistance, temperature, light-level, and more.

Voltage comparators can readily be made to activate relays (or alarms, or other circuits) when load currents (or temperatures, light levels, etc.) go outside of—or come within—preset limits. We'll look at some practical circuits in the next few pages.

Basic voltage comparator circuits

The easiest way to make a voltage comparator is to use an op-amp such as the CA3140; two basic configurations are shown in Fig. 1. The 3140 op-amp has a typical open-loop, low-frequency voltage gain of about 100 dB, so its output can be shifted from the high to the low state (or vice versa) by shifting the input voltage a mere 100 μ V (microvolts) or so above or below the reference voltage value. The CA3140 can be powered from either a single-ended or split power supply and it provides an output that typically swings to within a couple of volts of its positive rail or to within a few millivolts of its negative (or zero) supply rail. Unlike many other

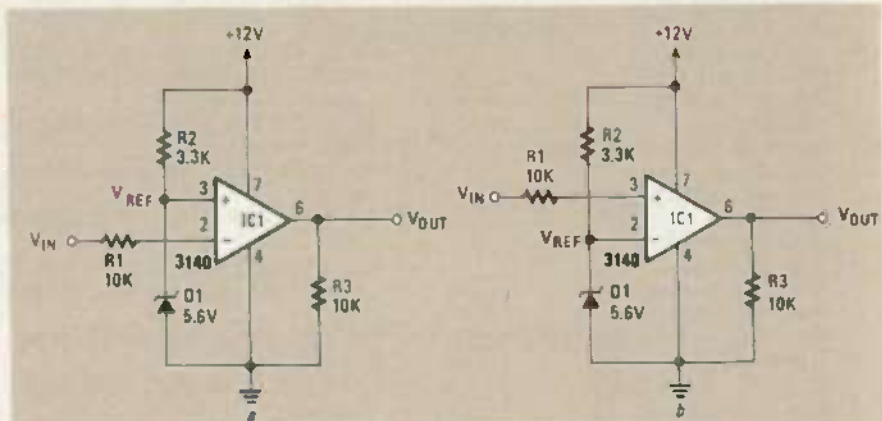

FIG. 1—BASIC VOLTAGE-COMPARATOR CIRCUITS.

op-amps, the 3140 can accept input voltages all the way down to the negative rail value.

The operation of the circuit in Fig. 1-a is very simple: A fixed reference-voltage (V_{REF}) is generated via the combination of $R2$ and Zener diode $D1$. It is applied directly to pin 3, the non-inverting input terminal of the op-amp. The input or test voltage V_{IN} is applied to the inverting input terminal (pin 2) via current-limiting resistor $R1$. When V_{IN} is below V_{REF} the op-amp output is driven high (to positive saturation), but when V_{IN} is above V_{REF} the output is driven low (to negative saturation). That response is shown graphically in Fig. 2-a.

By simply interchanging the connections to pins 2 and 3, the action of the circuit can be reversed; the op-amp output

is normally low, but goes high when V_{IN} exceeds V_{REF} . That circuit is shown in Fig. 1-b, and its response is shown graphically in Fig. 2-b.

There are a few points worth noting about the basic single-supply voltage-comparator circuits in Fig. 1. The first point is that the reference voltage can be given any value from zero up to within 2 volts of the positive supply-rail. Thus, either circuit can be made to trigger at any desired value between those limits by simply interposing a potentiometer between a fixed voltage-reference source and the " V_{REF} " pin of the op-amp.

The second point to note is that the voltage-input pin of the op-amp must be constrained to the range from zero volts up to within 2 volts below the positive supply-rail value. Thus, if you want the

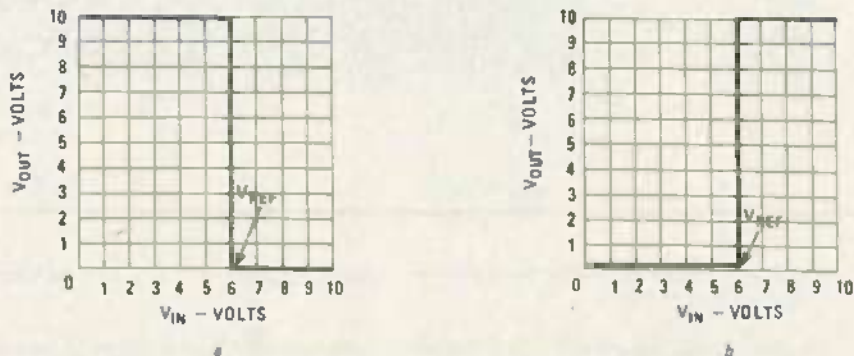

FIG. 2—THE ACTION OF THE VOLTAGE comparators shown in Fig. 1 is shown graphically here.

circuit to trigger at some high value of input voltage, you will have to feed the input voltage to a simple voltage divider before the op-amp input.

The final point to note about the basic voltage-comparator circuits is that they give a non-regenerative switching action, so that the op-amp is driven into the linear (non-saturated) mode when the input voltage is within a few tens of microvolts of V_{REF} . Under that circumstance, the op-amp output generates lots of spurious noise and that output will vary with slowly varying input signals. In some applications, that may be unacceptable. The problem can be overcome by using positive feedback, so that a regenerative switching action is obtained. The feedback signal introduces a degree of hysteresis in the voltage switching levels; the degree of hysteresis is directly proportional to the amount of feedback.

Special voltage-comparator circuits

Figures 3 to 7 show how the three points mentioned above can be put to practical use to make various types of "special"

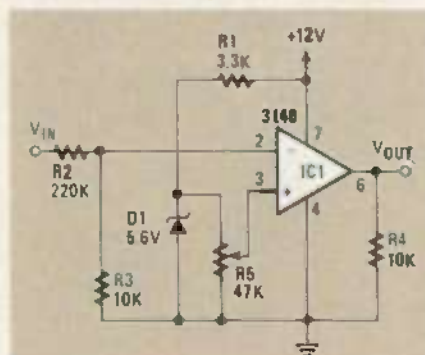

FIG. 5—A VOLTAGE DIVIDER allows us to use the voltage comparator to give high-value, variable-voltage triggering. This circuit does not offer regenerative switching.

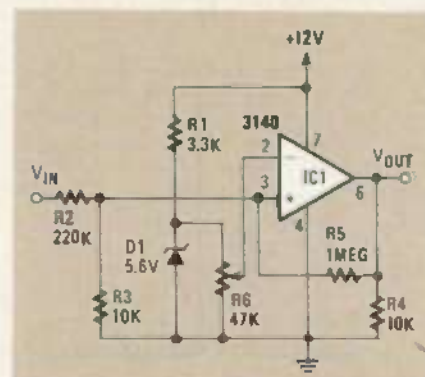

FIG. 6—THIS CIRCUIT, like that in Fig. 5, gives us high-value, variable-voltage switching. It offers regenerative switching.

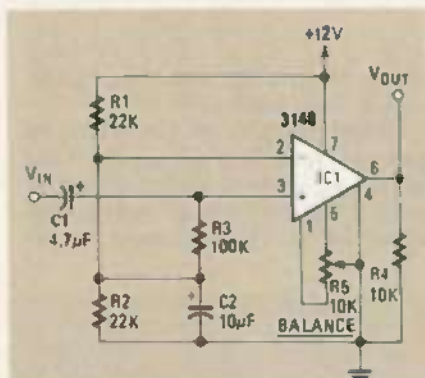

FIG. 7—THIS SINEWAVE-TO-SQUAREWAVE converter needs an input of under 100 mV to provide a 10-volt P-P squarewave output. The circuit can be used to about 15 kHz.

voltage-comparator circuits; plenty of other variations are possible. For example, Figs. 3 and 4 show how the basic comparator circuits can be modified so that the switching voltage can be varied by using a potentiometer (R5) to set the desired reference or trigger voltage at any value in the range 0–5.6 volts and to give regenerative (noiseless, snap-action) switching by feeding part of the op-amp output back to the non-inverting terminal

via R3. Note that in Fig. 4, the circuit's input terminal is terminated via R6 to ensure controlled hysteresis.

Figures 5 and 6 show examples of how the circuits can be modified to give high-value, variable-voltage (0–150 volt) triggering by interposing a simple voltage divider (R2 and R3) between the input signal and the input of the op-amp: The circuit in Fig. 5 gives non-regenerative switching, while that in Fig. 6 gives regenerative switching.

Figure 7 shows how the comparator can be used as a sensitive audio converter that converts sinewaves to squarewaves. It can operate from input-signal amplitudes as low as 10 mV peak-to-peak at 1 kHz and can produce decent squarewave outputs from sinewave inputs with frequencies up to about 15 kHz. The converter's input impedance is 100K. The operation of the circuit is rather simple: The voltage divider made up of R1 and R2, and capacitor C2 apply a decoupled reference voltage to pin 2 of the op-amp and an almost identical voltage is applied to signal-input pin 3 via isolating resistor R3. When a sinewave is fed to pin 3 via C1, it swings pin 3 about the pin-2 reference level, causing the op-amp output to transition at the "zero voltage difference" cross-over points of the input waveform and produce a squarewave output. Potentiometer R5 is used to bias the op-amp so that its output is just pulled low with zero input signal applied (so that the circuit operates with maximum sensitivity and stability). Because of the gain-bandwidth product characteristics of the op-amp, circuit sensitivity decreases as input frequency increases.

Window comparators

The voltage-comparator circuits that we have looked at so far give an output transition when the inputs go above or below a single reference-voltage value. It's a fairly simple matter to interconnect a pair of voltage comparators so that an output transition is obtained when the inputs fall between, or go outside of, a pair of reference-voltage levels. Figure 8-a shows the basic configuration, which is known as a window comparator.

The action of the circuit is such that the output of the upper op-amp goes high when V_{IN} exceeds the 6-volt V_U (upper limit) reference value, and the output of the lower op-amp goes high when V_{IN} falls below the 4-volt V_L (lower limit) reference value. By feeding the outputs of the two op-amps to R4 the D1-D2 diode OR gate, we get the situation where the final output is low when V_{IN} is within the limits set by V_U and V_L , but goes high when the input is outside those limits.

By taking the output via a simple inver-

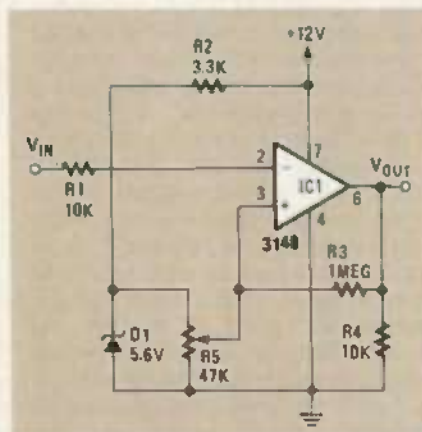

FIG. 3—THIS UNDER-VOLTAGE SWITCH lets you vary the V_{REF} trip point and offers regenerative feedback.

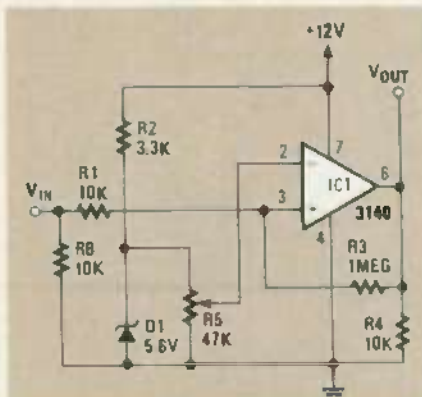

FIG. 4—THIS OVER-VOLTAGE SWITCH also offers regenerative feedback and adjustment of V_{REF} .

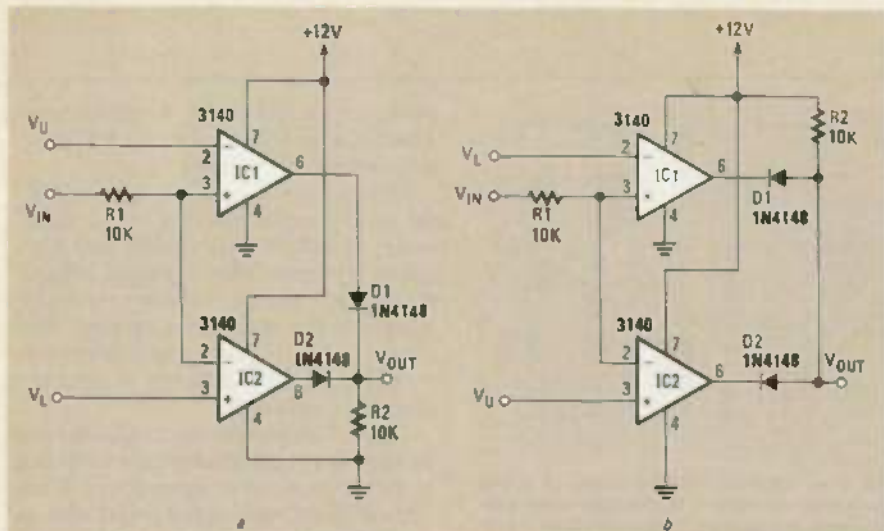

FIG. 8—TWO WINDOW COMPARATORS. When V_{IN} is outside the window determined by V_U and V_L , the output of the circuit in *a* goes high while the output of the circuit in *b* goes low.

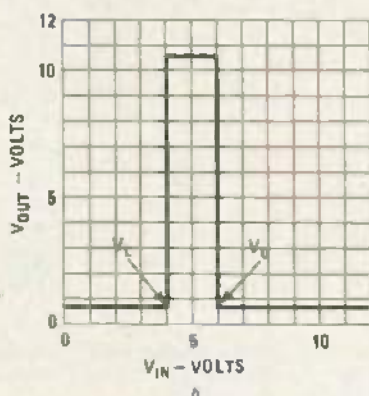
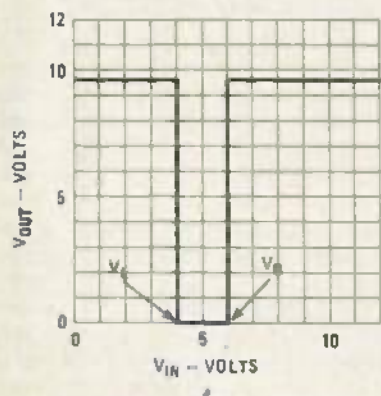

FIG. 9—THE ACTION OF THE WINDOW COMPARATORS shown in Fig. 8-a and 8-b are shown here in *a* and *b* respectively.

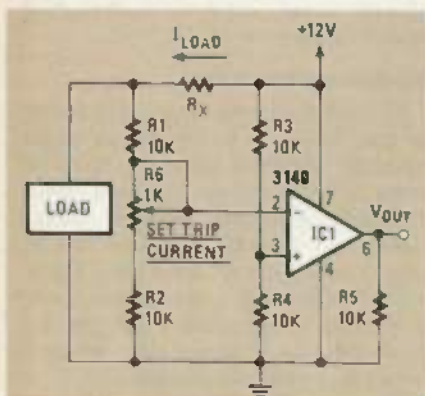

FIG. 10—OVER-CURRENT SWITCH. The output goes high when the load current exceeds a value determined by the setting of R_6 . By reversing the connections to pins 2 and 3 of IC_1 , the output will go low to signal the over-current condition.

circuits shown in Fig. 8 are shown graphically in Figs. 9-a and 9-b.

Window comparators can readily be made to activate from any parameter that can be turned into an analog voltage, in the same way as a "normal" voltage comparator can. Let's look at some examples.

ter stage, the action of the circuit in Fig. 8-a can be reversed so that its output goes high only when the input voltage is within the "window" limits. Alternatively, the required action can be obtained by transposing the two reference voltages and taking the output via a diode AND gate, as shown in Fig. 8-b. The actions of the two

Analog-activated comparators

Figure 10 shows how a comparator circuit can be made to function as an over-current switch that gives a high output when the load current exceeds a certain value—which you can choose via potentiometer R_6 . The value of R_X is chosen so that it drops roughly 100 millivolts at the required trip point. Thus, a fixed reference voltage of 1/2 the supply voltage is fed to pin 3 of the op-amp via the voltage divider made up of R_3 and R_4 . A similar but current-dependent voltage is fed to pin 2 via R_X , R_1 , R_6 , and R_2 . In effect, those two sets of components are configured as a Wheatstone bridge—with one side feeding pin 3 and the other side feeding pin 2—and the op-amp is used as a bridge-balance detector. Consequently, the trip points of the circuit are not significantly influenced by supply-voltage variations but are highly sensitive to load-current variations.

By simply transposing the connections to pins 2 and 3, the action of the circuit in Fig. 10 can be reversed so that it functions as an under-current switch: The circuit can then be used as a lamp- or load-failure indicator in cars, test gear, etc.

Figure 11 shows the circuit of a sensitive AC over-voltage switch that gives a high output when the input signal exceeds a peak value (6 mV to 111 mV) that is preset via potentiometer R_{12} . The AC input signal is applied to the non-inverting input of variable-gain amplifier IC_1 . Its gain can be varied from 45 to 850 via R_{12} . Note that the input of IC_1 is DC-grounded via R_1 - R_2 , so the op-amp responds only to the positive half-cycles of the input signal. Consequently, the output of IC_1 is an amplified, half-wave-rectified version of the input signal. That rectified signal is peak-detected via R_5 , D_1 , C_2 , R_6 , and R_7 , and is fed to the input of non-inverting voltage comparator IC_2 . The circuit's output is positive when the voltage across C_2 exceeds the value on the junction of R_8 - R_9 .

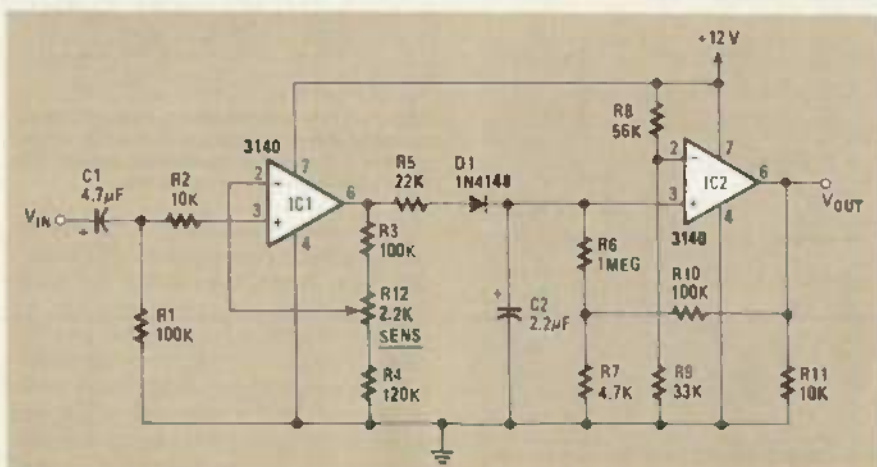

FIG. 11—AC OVER-VOLTAGE SWITCH can be triggered by input signals in the range of 6 mV to 111 mV peak.

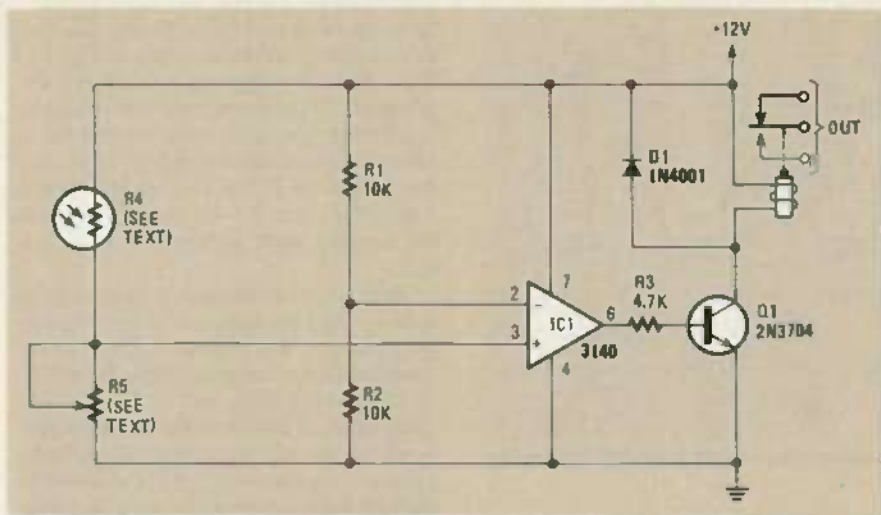

FIG. 12—THIS PRECISION OVER-TEMPERATURE SWITCH will control a relay.

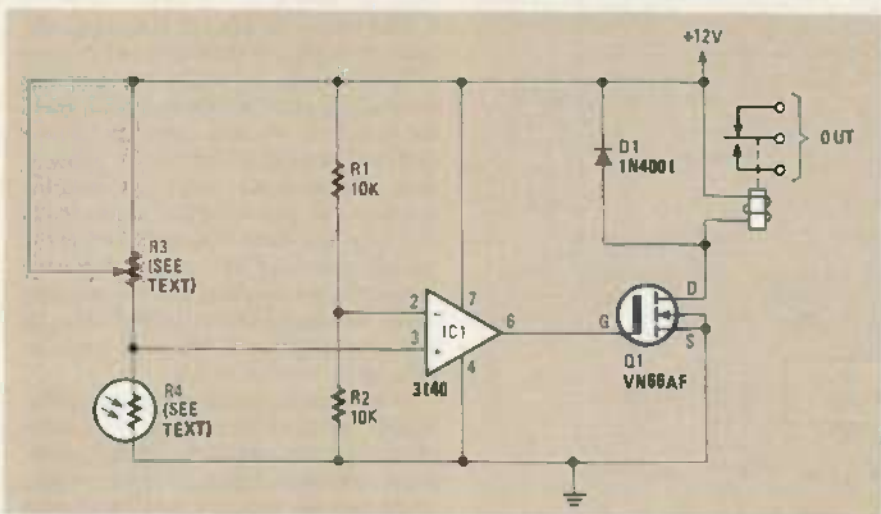

FIG. 13—THIS UNDER-TEMPERATURE SWITCH also will control a relay.

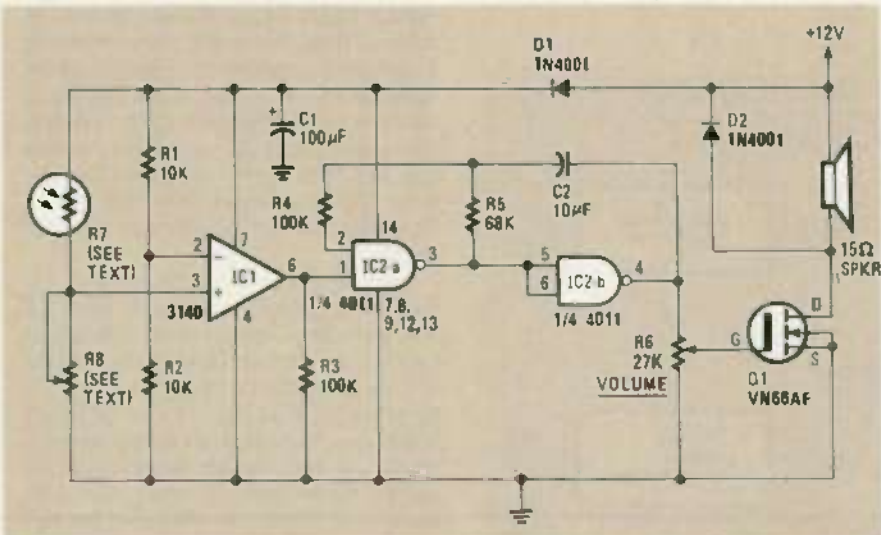

FIG. 14—LIGHT-OPERATED SWITCH. A monotone alarm will sound when the light detected by R7 rises above a value determined by the setting of R8.

Figures 12 to 15 show a variety of ways you can use comparator circuits as light- or temperature-activated switches. For light-sensitive circuits we use a cadmium-

sulfide photocell; for temperature-sensitive circuits we use an NTC (Negative-Temperature-Coefficient) thermistor as the sensing element. The sensing ele-

ment is used as one arm of a Wheatstone bridge and the op-amp is used as a simple bridge-balance detector. Thus, the trip point of each circuit is independent of supply-voltage variations. In all cases, the sensing element must have a resistance in the range 5K to 100K at the required trip point. The potentiometer is chosen to have the same resistance value as the sensing element at the required trip level.

The circuits shown in Figs. 12-15 also show a variety of ways we can use the output of the op-amp to activate a relay or to generate an acoustic alarm signal. Thus, the over-temperature switch in Fig. 12 has a transistor-driven relay output, while the under-temperature switch in Fig. 13 has a FET-driven relay output. Similarly, the light-operated switch circuit of Fig. 14 generates a monotone alarm output signal in a small speaker, while the dark-operated switch of Fig. 15 generates a low-power pulsed-tone signal in a small acoustic transducer.

Micro-power operation

All of the 3140-based comparator circuits that we have looked at so far are continuously powered; they draw continuous currents of about 4 mA per op-amp. So if you wanted to use a 9-volt battery as a power supply, you'd find it running down after a couple of days of continuous operation. As you can see, the circuits that we've shown you so far are not well suited to battery operation in portable applications. In practice, however, all of those circuits can easily be modified for long-life battery operation by using a micro-power "sampling" technique; the principle behind that technique can be explained very easily with a simple example, as follows.

The under-temperature switch shown in Fig. 13 monitors temperature continuously and draws about 5 mA of quiescent current (with the relay off). In reality, however, temperature is a slowly-varying parameter and thus does not need to be monitored continuously—it can be efficiently monitored by briefly inspecting or sampling it. We can sample it by connecting the supply power and looking at the op-amp output only once every second or so. If the sample periods are very brief (say 300 microseconds) relative to the sampling interval (1 second), the mean current consumption of the monitor can be reduced by a factor equal to the interval/period ratio (in this example, by a factor of 3300). Thus, by using the sampling technique, we can reduce the 5-mA consumption of circuit in Fig. 13 to a mean value of 1.6 μ A.

Figure 16 shows the basic circuit of a "micro-power" or sampling version of the under-temperature switch we saw in Fig. 13. It operates the relay when the temperature of the thermistor falls below a preset value but it draws a mean quiescent

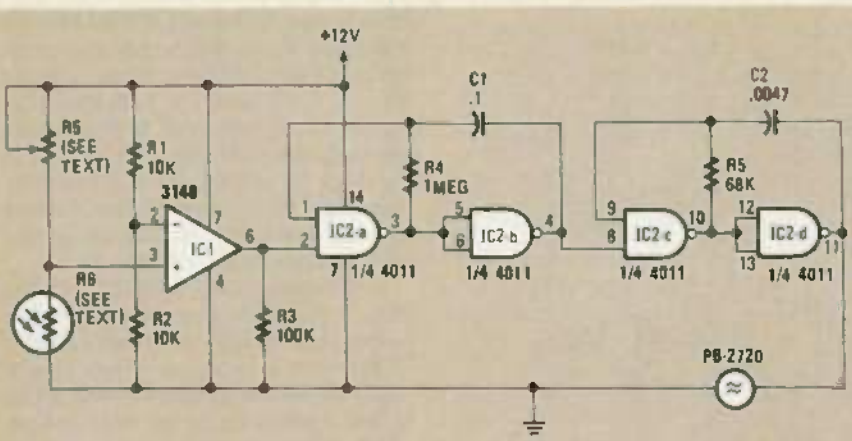

FIG. 15—ANOTHER LIGHT-OPERATED SWITCH. A pulsing tone will sound when the light detected by R6 falls below a value determined by the setting of R6.

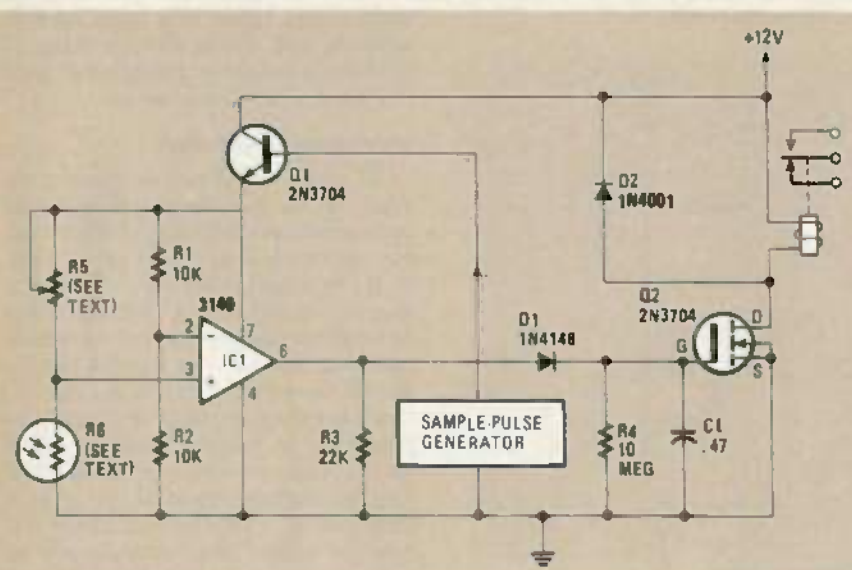

FIG. 16—MICRO-POWERED UNDER-TEMPERATURE SWITCH draws a quiescent current of only a few microamps.

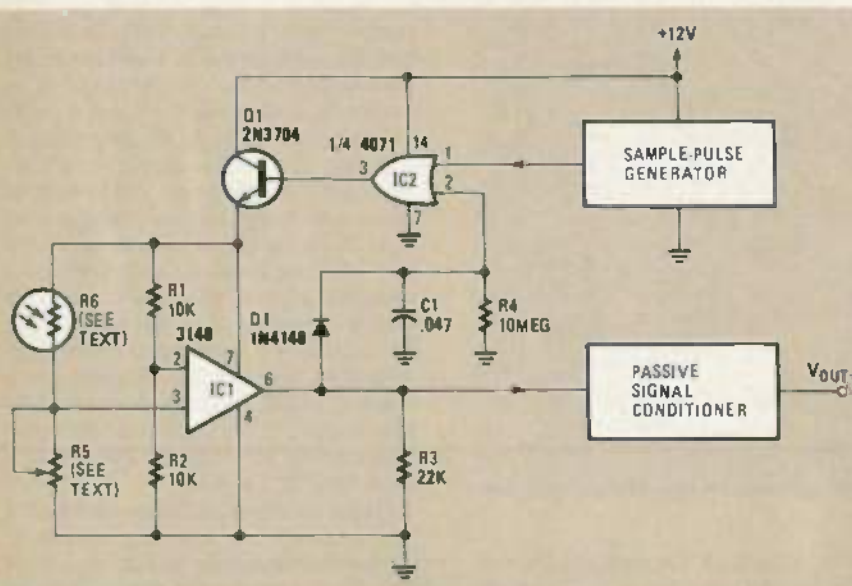

FIG. 17—THIS CODED-LIGHT-BEAM DETECTOR uses a modified version of the sampling technique to monitor for the presence of a coded light-signal.

current of only a few μA . The monitor network, made up of R5, R6, R1, R2, and IC1, is almost identical to that of Fig. 13. But instead of being continuously powered, it is powered via a 300-microsecond pulse just once every second via a sample-pulse generator and Q1. Note that the output of IC1 is led to temporary "memory" store R4-C1 via D1, and that the memory store operates the relay via Q2.

Thus, if the thermistor temperature is outside the trip level when the sample pulse arrives, the output of IC1 will remain low and no charge will be fed to C1, so Q2 and the relay will be off. On the other hand, if the thermistor temperature is within the trip level when the sample pulse arrives, the output of IC1 will switch high for the duration of the pulse and thus rapidly charge C1 up via D1 and drive the relay on via Q2.

The circuit in Fig. 16 illustrates the basic principles of the micro-power sampling technique. In reality the sampling interval and pulse width used (and, thus, the reduction in mean power consumption) will depend on the specific application. If, for example, you wish to monitor transient changes in light or sound levels and know that these transients have minimum durations of 100 ms, you may have to use a 50-ms sampling interval and (say) a 500 μs sample pulse. In that case the mean consumption of your circuit will be reduced by a factor of 100.

In some cases, you may have to slightly modify the operating principle of the sampling circuitry to obtain the desired micro-power operation. Figure 17, for example, shows how the principle may be adapted to make a coded-light-beam detector, in which the "code" light signal is modulated at 1 kHz for a minimum duration of 100 ms. Thus, the sample-pulse generator is designed to produce a minimum pulse width of 1.2 ms so that it can capture at least one full 1-kHz code cycle. Further, the sampling interval is set at 60 ms so that part of a tone burst will always be captured. The sampling circuitry thus gives a 50:1 reduction in monitor-current consumption.

Thus, in the circuit shown in Fig. 17, the sample generator repeatedly feeds 1.2 ms "inspection" pulses to the 3148 detector circuitry via one input of the OR gate and via Q1 to see if any trace of a coded signal exists: If no trace of a coded signal is detected, the output of the op-amp remains low and another sample pulse is applied 60 ms later. If a trace of a code signal is detected, the output of the op-amp switches high and the resulting pulse is "captured" and applied to the remaining input of the OR gate. That temporarily applies full power to the 3148 circuitry so that the code signal can be completely inspected via the passive signal conditioning circuitry. R-E

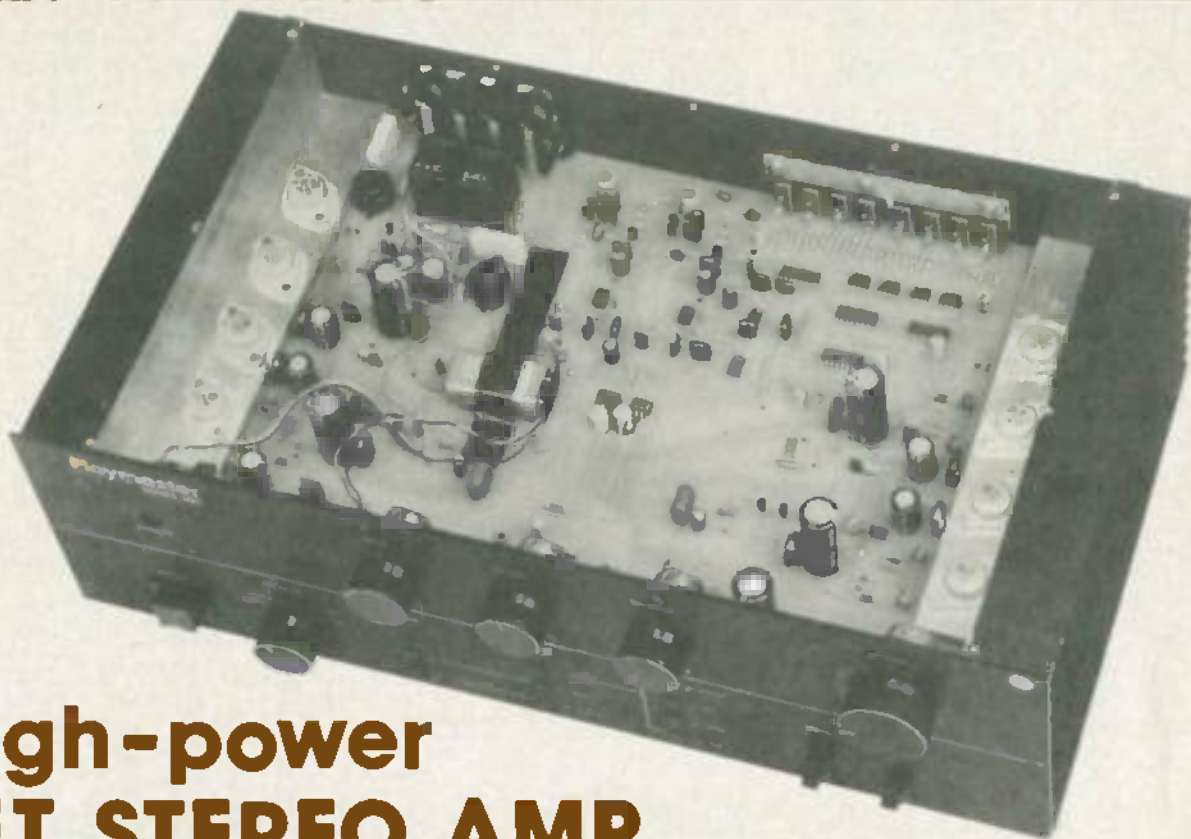

High-power FET STEREO AMP

Our amp's high-power output, low distortion, and easy construction make it a must for audiophiles who demand the very best!

LEO SIMPSON AND JOHN CLARKE*

IF YOU'VE BEEN WAITING FOR AN EXCUSE to junk your prehistoric stereo amplifier, your wait is over. Here's an amplifier that provides a conservatively-rated 95 watts (rms) per channel at eight ohms, with distortion that is less than 0.02%. Our amplifier can be built in a few evenings for under \$300, and it will provide you with years of listening enjoyment as well as the satisfaction of knowing that the very latest in audio technology is providing that enjoyment.

The amplifier has all the latest convenience features, such as dual-recorder tape dubbing, speaker switching, muting, and a battery backup so that the amplifier will "remember" its configuration and return to that configuration the next time it is powered up.

The amplifier has four inputs: PHONO, CD, TUNER, and AUXILIARY. The latter could be connected to a stereo TV tuner, a high-fidelity VCR, or another source. We also provide switching to monitor any one of the main inputs, or one of the two tape

inputs. In addition, switching and the appropriate signal routing are provided so that you can dub from either tape recorder to the other. The amp also has provisions for connecting two pairs of loudspeakers; either, neither, or both pairs may be used at any time. In addition, a headphone jack is provided that is always "hot."

The amplifier is rather large. Overall it measures about 19 × 11.5 × 6 (inches). The size of the heatsinks determines the height and depth; those specially-tooled aluminium extrusions are necessary to cope with the large amount of heat dissipated when the amplifier is working near maximum output. Normally the heatsinks are just warm to the touch. The 19-inch width was chosen so that the amplifier could be rack-mounted, if the builder so desired.

Design philosophy

The amplifier represents the latest in a series of amplifiers that have been developed over the last ten years. We took the best features of the previous designs and combined them with the latest technical advancements to produce a truly su-

perior amplifier. For the description that follows, see the block diagram of the amplifier that appears in Fig. 1. After discussing the overall operation of the circuit, we'll discuss each subsection in detail.

One paramount design goal was to eliminate the great amount of tedious hand-wiring of switches, controls, and jacks normally required by a project like this. We wanted to use a one-piece molded assembly for the input jacks so that it could be soldered to the PC board as a unit. That eliminates the need for shielded cabling, but creates a more severe problem: How could we provide appropriate switching for source selection, tape monitoring and dubbing from deck to deck?

We considered a mechanical switching solution, but there didn't seem to be any practical way of integrating mechanical switches neatly. So we considered using CMOS analog switches, since they are cheap and readily available in various configurations. However, analog switches are not without problems of their own. In an improper design, they can generate

*Adapted from material published by *Electronics Australia*

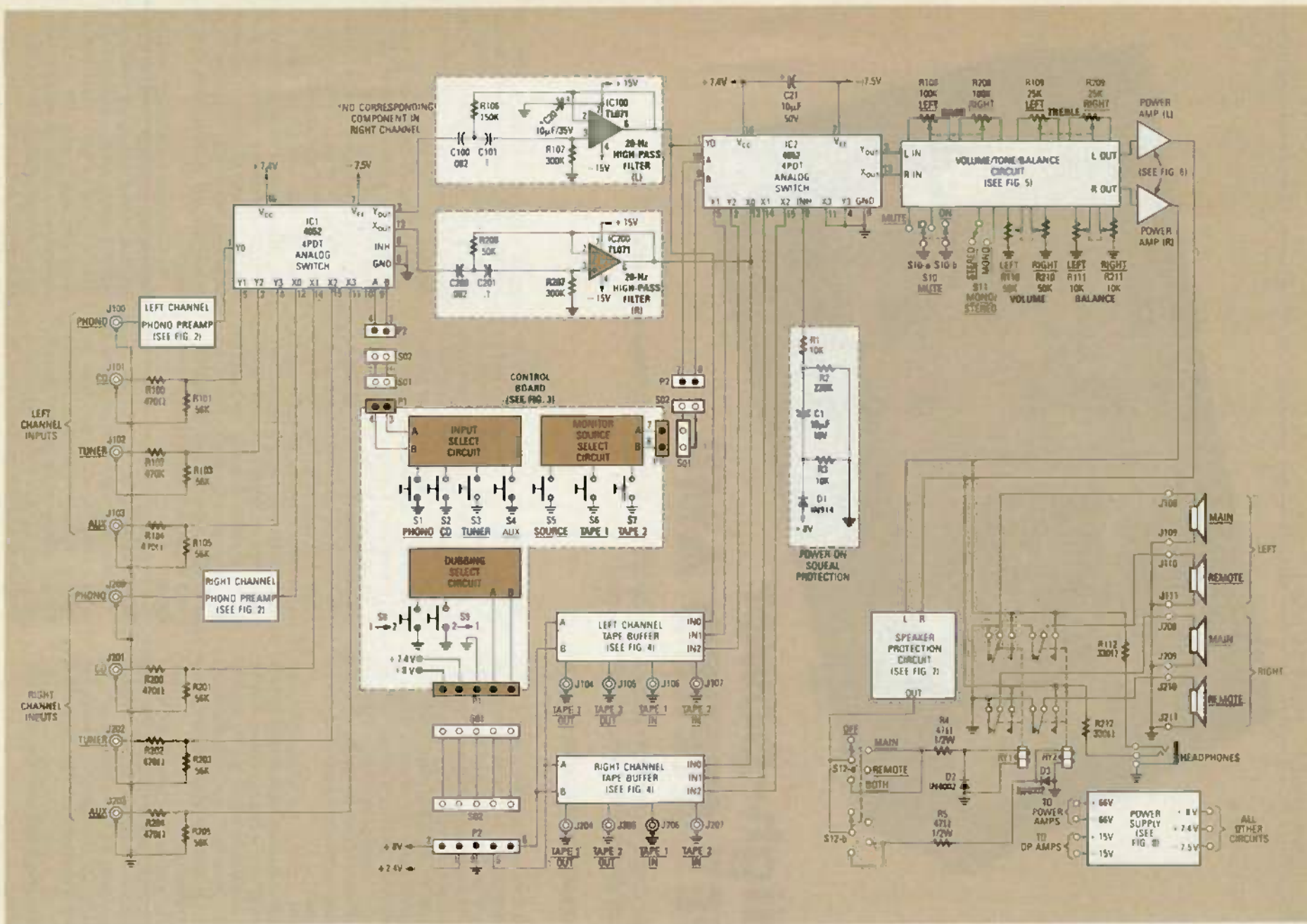

FIG. 1—OUR AMPLIFIER IS COMPOSED OF SEVERAL SUBSECTIONS, and the interconnections between them is shown here. The details of each subsection are shown in separate schematics.

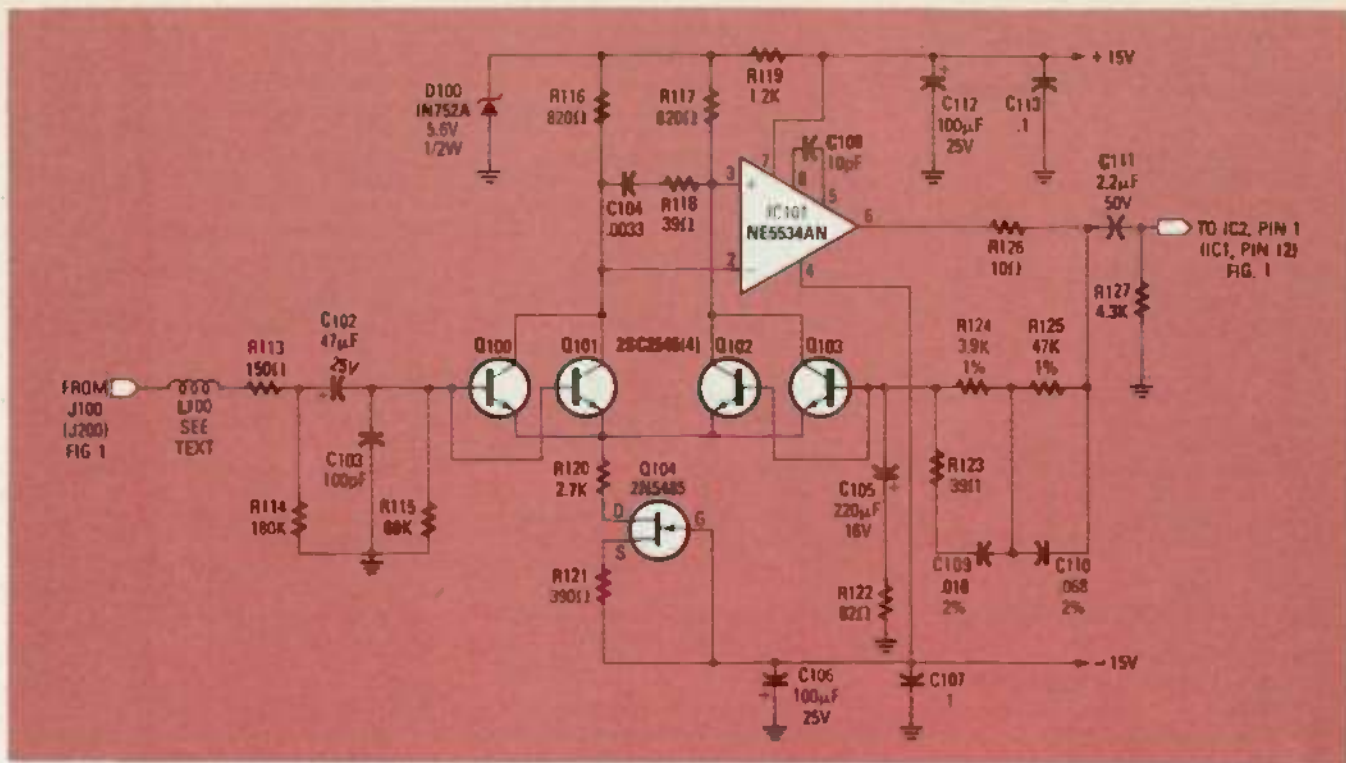

FIG. 2—THE RIAA PHONO PREAMPLIFIER IS COMPOSED OF A BIPOLAR DIFFERENTIAL AMPLIFIER AND AN OP-AMP. THE TRANSISTORS ARE SPECIAL LOW-NOISE TYPES.

distortion. In addition, some sort of memory system would be required so that the amplifier's configuration would be "remembered" when the amplifier was turned off.

We overcame the distortion problem by buffering the outputs of the switches with low-noise FET-input op-amps (TL071's). Since distortion is caused by the non-linear resistance of the CMOS gate, it follows that, if the current through the gate were minimized, distortion would likewise be minimized. We achieve minimum distortion by buffering the output of each CMOS gate with a high-input-impedance, unity-gain op-amp. Buffering requires a few extra op-amps and discrete components, but we believe that the results more than justify the expense.

As for the memory problem, we could have built in some RAM (Random Access Memory) and perhaps a microprocessor to control it, as some commercial Japanese designers have done, but that seemed like overkill. Instead, we chose to implement our memory with several CMOS gates and flip-flops, which are powered by a pair of Ni-Cd cells when the amplifier is off. The flip-flops, switches, and indicator lights mount on a separate PC board, the control board.

Several other analog switches are mounted on the main PC board. For example, IC1 is the electronic equivalent of a 4PDT mechanical switch: it performs the input-source selection. Depending on the state of its A and B inputs, one pair of signals presented to the X and Y inputs is passed through to the appropriate outputs.

For example, with both A and B low, the left- and right-channel outputs from the phono preamplifier would appear at the YOUT and XOUT terminals, respectively.

Whichever signals are chosen, they pass through the 20-Hz high-pass (rumble) filters composed of IC100, IC200, and the associated discrete components. Those filters provide a 12-dB/octave roll-off below the corner frequency. (Due to filtering networks in the phono preamplifier, phonograph signals are rolled off a total of 18-dB/octave.) The op-amp rumble filters also provide high-impedance buffering that reduces loading on the analog switches. That loading could cause distortion.

By the way, for the sake of clarity, all left-channel components are numbered from 100-299; right-channel components are numbered from 200-299; and components common to both channels are numbered from 1-99.

Another analog switch, IC2, routes one of the main inputs or one of the tape recorder inputs through to the Volume/Tone/Balance circuit. The network attached to the INHIBIT input (pin 6) of IC2 forces that IC to turn on slowly, and that helps minimize power-on squeal through the headphones.

After passing through IC2, the stereo signals are processed by the Volume/Tone/Balance circuit, which also contains the MUTE switch and the STEREO/MONO switch. The signals are next presented to the power amplifiers and then to the speaker protection circuit and relays RY1 and RY2.

We had a problem with loudspeaker switching. We didn't want heavy wires running between the front-panel selector switch and the speaker output terminals. In addition, switches capable of handling the 10 amps or so of current the amplifier can develop at full power are expensive and not readily available. We solved the problem by letting a couple of relays do the switching. That solution allows us to use a small rotary switch to control just the coils of the relays. Further, that makes it easy to implement circuitry to provide power-on muting as well as to protect the speakers from an output-transistor failure.

The power supply is mounted beneath the main circuit board. Since the power supply is mounted so close to the main circuit board, we had to use a power transformer with a very low external hum field. Low hum is achieved by using a toroidal transformer that has the additional benefit of small size. Other special features of the power supply include 16,000 μ F of capacitance on each of the 66-volt supplies, and a special, isolated +7.4-volt source for the CMOS switching components and their battery back-up.

With that background in mind, let's start over. Let's go back to the input of the circuit and examine each stage in detail.

The RIAA preamplifier

The complete schematic of the left-channel preamp is shown in Fig. 2. The right channel is identical, here and in other figures, unless a notice appears in a figure stating otherwise. We use special

PARTS LIST

All resistors 1/4-watt. 5% unless otherwise stated.

R1, R3—10,000 ohms
 R2—220,000 ohms
 R4, R5—47 ohms, 1/2 watt
 R6—R9, R11—R14, R16, R18—100,000 ohms
 R10, R15, R17, R19, R100, R102, R104, R158, R163, R200, R202, R204, R258, R263—470 ohms
 R20, R21, R22, R23—22,000 ohms, 1/2 watt
 R24, R25, R101, R103, R105, R201, R203, R205—56,000 ohms
 R26, R129, R121, R229, R231, R132, R232, R134, R234—270,000 ohms
 R27, R128, R130, R144, R228, R230, R244—2200 ohms
 R28, R159—R162, R259—R262—220 ohms
 R29—130 ohms
 R30, R31, R136, R151, R236, R251—1000 ohms
 R32—1500 ohms
 R33—R99, R165—R199, R2285—R299—unused
 R106, R206—150,000 ohms
 R107, R207—300,000 ohms
 R108, R208—100,000 ohms, potentiometer
 R109, R209—25,000 ohms, linear potentiometer
 R110, R210—50,000 ohms, logarithmic potentiometer
 R111, R211—10,000 ohms, linear potentiometer
 R112, R212—330 ohms
 R113, R213—150 ohms
 R114, R214—180,000 ohms
 R115, R215—68,000 ohms
 R116, R117, R216, R217—820 ohms
 R118, R123, R218, R223—39 ohms
 R119, R219—1200 ohms
 R120, R220—2700 ohms
 R121, R221—390 ohms
 R122, R222—82 ohms
 R124, R224—3900 ohms, 1%, metal film
 R125, R225—47,000 ohms, 1%, metal film
 R126, R226—10 ohms
 R127, R227—4300 ohms
 R133, R135, R149, R150, R233, R235, R249, R250—4700 ohms
 R137, R138, R143, R145, R146, R148, R155, R237, R238, R243, R245, R246, R248, R255—22,000 ohms
 R139, R140, R239, R240—3900 ohms
 R141, R147, R241, R247—680 ohms
 R142, R232—68 ohms
 R152, R252—12,000 ohms, 1 watt
 R153, R154, R157, R253, R254, R257—100 ohms
 R156, R256—500 ohms, trimmer
 R164, R264—6.8 ohms, 1 watt
Capacitors
 C1, C14—C22, C116, C120—10 μ F, 50 volts, electrolytic
 C2, C3—0.047 μ F, polyester
 C4, C5—47 μ F, 50 volts, non-polarized
 C6—100 μ F, 16 volts, electrolytic
 C7—0.01 μ F, 250 volts, polyester
 C8—C11—8000 μ F, 75 volts, electrolytic
 C12, C13—1000 μ F, 25 volts, electrolytic
 C23—C99, C144—C199, C214, C225, C226, C244—C299—unused
 C100, C200—0.082 μ F, polyester
 C101, C107, C113, C142, C201, C207, C213, C242—0.1 μ F, polyester
 C102, C202—47 μ F, 25 volts, electrolytic
 C103, C203—100 pF, ceramic
 C104, C204—0.0033 μ F, polyester
 C105, C205—220 μ F, 16 volts, electrolytic
 C106, C112, C206, C212—100 μ F, 25 volts, electrolytic
 C108, C208—10 pF, ceramic
 C109, C209—0.018 μ F, 2%, polyester
 C110, C210—0.068 μ F, 2%, polyester
 C111, C211—2.2 μ F, 50 volts, non-polarized
 C112, C212—100 μ F, 25 volts, electrolytic
 C114—10 μ F, 25 volts, electrolytic
 C115, C215—10 μ F, 50 volts, non-polarized
 C117, C217—0.056 μ F, polyester
 C118—2200 μ F, 16 volts, electrolytic
 C119, C127, C219, C227—18 pF, ceramic
 C121, C221—50 μ F, 16 volts, non-polarized
 C122, C222—0.01 μ F, polyester
 C123, C124, C223, C224—0.0047 μ F, polyester
 C128, C228—6.8 μ F, 16 volts, non-polarized
 C129, C229—1 μ F, 100 volts, non-polarized
 C130, C230—330 pF, ceramic
 C131, C231—0.015 μ F, 250 volts, polyester
 C132, C232—47 μ F, 25 volts
 C133, C233—15 pF, ceramic
 C134, C136, C234, C238—100 μ F, 100 volts, electrolytic
 C135, C136, C139, C140, C235, C236, C239, C240—0.22 μ F, polyester
 C137, C141, C237, C241—22 μ F, 100 volts, electrolytic
 C143, C243—0.15 μ F, 250 volts, dual-di-electric (Phillips type PKT-P)
Semiconductors
 IC1, IC2—4052 4PDT analog switch
 IC3—IC6—4011 CMOS NAND gate
 IC7—74C14 CMOS hex Schmitt trigger
 IC8—4013 CMOS dual D flip-flop
 IC9—7815 15-volt positive regulator
 IC10—7805 5-volt positive regulator
 IC11—7915 15-volt negative regulator
 IC12—IC99, IC105—IC199, IC205—IC299—unused
 IC100, IC102, IC103, IC200, IC202, IC203—TL071 low-noise op-amp
 IC101, IC201—NE5534AN bipolar op-amp
 IC104, IC204—4053 CMOS triple SPDT analog switch
 BR1—400-volt, 10-amp bridge rectifier
 D1, D4—D17, D23, D101—D105, D201—D205—1N914
 D2, D3, D18—D22, D108, D109, D208, D209—1N4002
 D24—D99, D110—D199, D210—D299—unused
 D100, D200—1N752A, 5.6-volt, 1/2-watt Zener diode
 D106, D107, D206, D207—1N4739A, 9.1 volt, 1-watt Zener diode
 LED1—LED9—Standard red LED
 Q1, Q3, Q4—BC547
 Q2—BC557
 Q5—BC327
 Q6—Q99, Q115—Q199, Q215—Q299—unused
 Q100—Q103, Q200—Q203—2SC2545
 Q104, Q204—2N5485
 Q105—Q107, Q205—Q207—BC556
 Q108, Q208—BF470
 Q109, Q110, Q209, Q210—BF469
 Q111, Q112, Q211, Q212—2SK134
 Q113, Q114, Q213, Q214—2SJ49
Other components
 B1, B2—Size AA Ni-Cd battery
 F1, F2—Fuse, 250 volts, 5 amps
 J1—Stereo headphone jack
 J100—J103, J200—J203, J104—J107, J204—J207—RCA Phono jack
 J108—J111, J208—J211—speaker connectors
 L100, L200—see text
 L101, L201—6.8 μ H
 P1, P2—9-pin SIP plug, 0.1" centers
 RY1, RY2—DPDT relay
 S1—S9—SPST normally open, momentary contact
 S10—DPST toggle
 S11—SPST toggle
 S12—2P4T rotary
 S13—SPST toggle switch, 250 volts AC
 T1—117 VAC primary, dual secondaries: 90 VCT and 30 VCT
Miscellaneous: Battery holder for B1 and B2, PC-mount fuse clips, Ferrite beads, 11-mm \times 25-mm coil forms
Note: The following components are available from Dick Smith Electronics, Inc., P.O. Box 8021, Redwood City, CA 94063; 800-332-5373 (orders) 415-368-8844 (Inquiries). Complete kit of all parts (No. K-3516) including PC boards, heatsinks, screened front and rear panels, and transformer T1, \$299 plus \$10 shipping. Separate components: set of two PC boards (No. KH-0106), \$49.00; 2SC2545 transistor (No. KZ-1683), \$0.39 each; 2SK134 transistor (No. Z-1815), \$4.50; 2SJ49 transistor (No. Z-1816), \$4.50; transformer T1 (No. KM-2000), \$57.00; case including panels and heatsinks (No. KH-2700), \$115. All component orders must add \$1.50 for handling plus 5% of total price. California residents must add 6.5% sales tax. Orders outside U.S. must include U.S. funds and add 15% of total price for shipping.

ultra-low-noise transistors made by Hitachi (part number 2SC2545) to form a differential amplifier that drives an operational amplifier. Doing that allows the

noise performance to be defined by the transistors rather than by the op amp and you can get better performance from discrete devices than from IC's.

The 2SC2545's are NPN types with very low intrinsic base resistance. We have found the 2SC2545 transistor superior in that respect to all others that we have

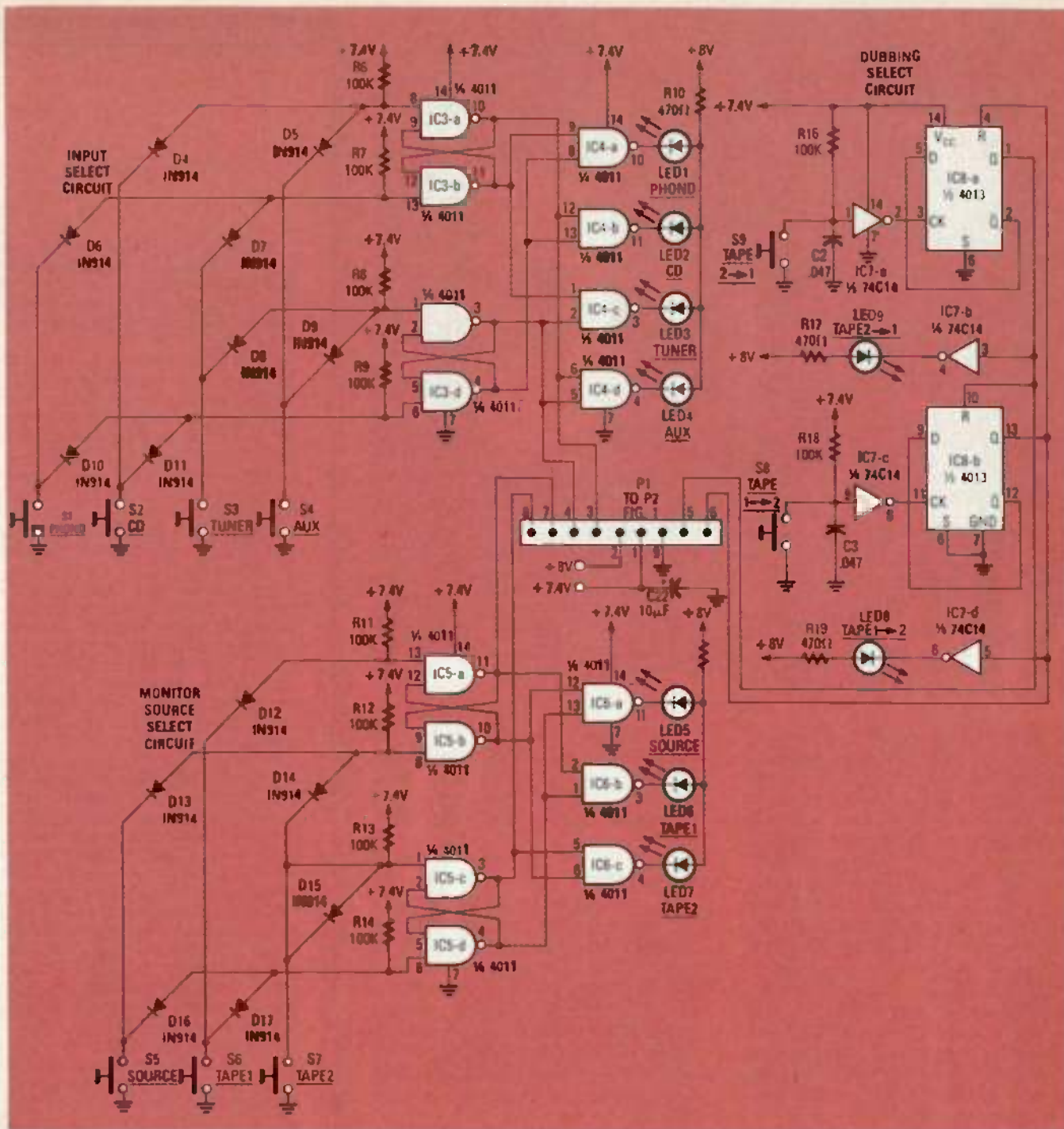

FIG. 3—THE CONTROL BOARD CIRCUITRY is shown here. Each section of the circuit is composed of several momentary switches that drive several flip-flops.

tested. To render residual noise in the phono preamp as low as possible, we use two transistors connected in parallel in each leg of the differential stage. That halves the intrinsic base resistance and improves noise performance a great deal.

Quiescent current through the differential pair is set at about 1.7 mA to optimize the signal-to-noise ratio for typical moving-magnet phono cartridges. That current is set by FET Q5, which functions as a constant-current source and ensures good common-mode performance, good PSRR (Power Supply Rejection Ratio), as

well as optimum gain. In general, the better the PSRR, the less likely an amplifier will respond to variations in the power supply, including large ripple signals (hum), or to harmonics of the input signal, which increase harmonic distortion. Resistor R120 (2700 ohms) is connected in series with the drain of Q5 to protect transistors Q100-Q103 should Q5 fail. A failure of that sort is unlikely, but a resistor is cheap insurance.

We use a Signetics NE5534A op-amp for output drive; its high-performance capabilities include: low-noise, high slow-

rate, and the ability to drive a 600-ohm load. That last capability is important for the circuit since it enables us to use a relatively-low-impedance negative-feedback network. The low-impedance network keeps circuit-generated noise to a minimum.

RIAA equalization is determined by the values of the components in the negative-feedback loop of the preamplifier (R124, R125, C109, C110). To ensure that there is minimum deviation from the ideal RIAA characteristic curve, those components should have tolerances of 1% or 2%,

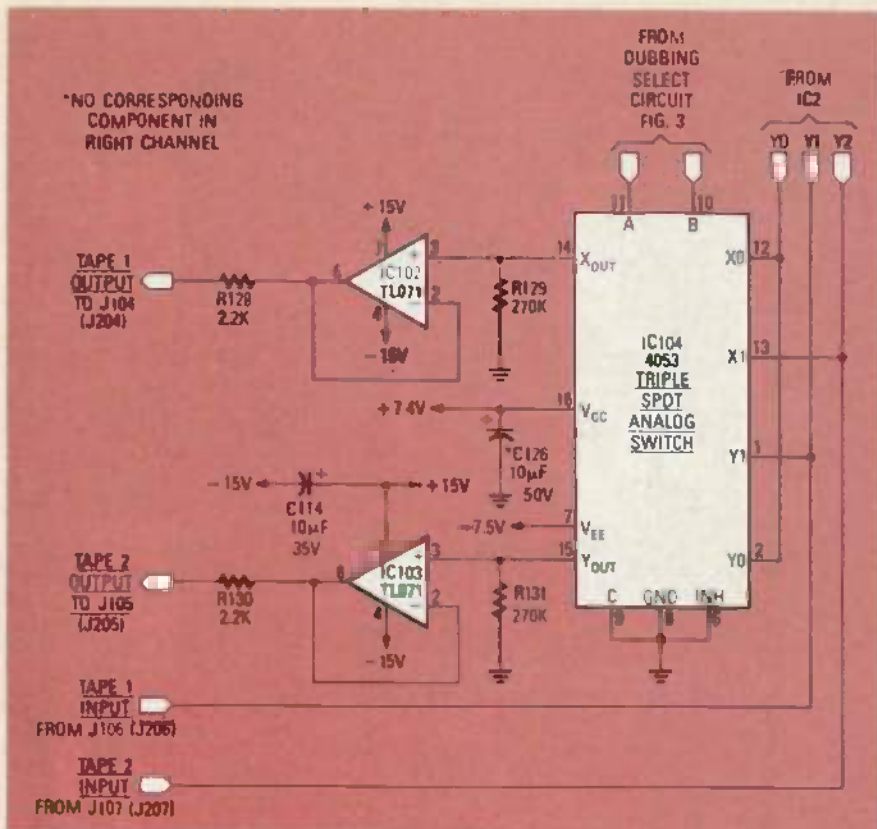

FIG. 4—THE TAPE BUFFER CIRCUITRY is shown here; it allows dubbing from either recorder to the other.

That keeps deviation within ± 0.5 dB.

Since the NE5534A is not internally compensated, a 10 pF capacitor is connected between pins 5 and 8 to ensure stability at unity gain, which occurs at high frequencies. In addition, a 39-ohm resistor is inserted in the RIAA feedback loop to prevent gain from rolling off unnecessarily at very high frequencies. That also reduces the distortion that might otherwise occur at high frequencies due to loading of the op-amp by the network.

The hand-wound toroidal inductor (L100) in the preamp's input reduces sensitivity to stray RF signals. Capacitor C102 (47 μ F) provides a low-impedance shunt path (via the coil of the cartridge) for noise produced by R115, the 68K bias and input load resistor.

The output of the preamplifier is coupled via a network consisting of a C111, a 2.2 μ F non-polarized unit, and R127; those components form a low-pass filter that attenuates frequencies above 20 kHz. Next the signal is fed to IC1, the 4PDT analog switch that also handles the high-level inputs (CD, TUNER, and AUXILIARY). That switch is powered by +7.4-volt and -7.5-volt supplies. The maximum peak-to-peak signal that can be handled by the switches without distortion is defined by the values of the plus and minus supplies. In our case, the maximum is about 15 volts, but the switch should never see more than about 2.5 volts rms, or 7 volts peak-to-peak.

As we said, the input source fed through to the rumble filters depends on the state of the A and B inputs. Those inputs are controlled by the circuitry on the control board. Let's examine that circuitry next.

Control board

The control circuitry is shown in Fig. 3; let's look at the *Input Select Circuit* first. Switches S1-S4 drive the cross-coupled gates of IC4, which are configured as an S-R (Set-Reset) flip-flop. Suppose you press S1, PHONO. That will force one input each of IC3-b and IC3-d to go low, which will in turn force their outputs high. Those outputs are connected to the inputs of IC4-a, so its output will go low and LED1 will light up.

The outputs of IC3-a and IC3-c are low now; those outputs are connected to the A and B inputs of IC1. Since both inputs are low, the X0 and Y0 inputs—the outputs of the phono pre-amps—to the analog switch will be fed through to the outputs.

The other switches in that section of the Control Board (S2-S4) work in a similar manner, as do the switches in the *Monitor Source Select* section. The latched outputs of the latter section are cabled to the A and B inputs of IC2, another 4052 4PDT analog switch; it serves to route one of the source inputs (Phono, etc.) or one the tape recorder inputs through to the volume control circuitry.

continued on page 90

One of the most difficult tasks in building any construction project featured in **Radio-Electronics** is making the PC board using just the foil pattern provided with the article. Well, we're doing something about it.

We've moved all the foil patterns to this new section where they're printed by themselves, full sized, with nothing on the back side of the page. What that means for you is that the printed page can be used directly to produce PC boards!

Note: The patterns provided can be used directly only for *direct positive photoresist methods*.

In order to produce a board directly from the magazine page, remove the page and carefully inspect it under a strong light and/or on a light table. Look for breaks in the traces, bridges between traces, and in general, all the kinds of things you look for in the final etched board. You can clean up the published artwork the same way you clean up your own artwork. Drafting tape and graphic aids can fix incomplete traces and doughnuts, and you can use a hobby knife to get rid of bridges and dirt.

An optional step, once you're satisfied that the artwork is clean, is to take a little bit of mineral oil and carefully wipe it across the back of the artwork. That helps make the paper translucent. Don't get any on the front side of the paper (the side with the pattern) because you'll contaminate the sensitized surface of the copper blank. After the oil has "dried" a bit—patting with a paper towel will help speed up the process—place the pattern front side down on the sensitized copper blank, and make the exposure. You'll probably have to use a longer exposure time than you are probably used to.

We can't tell you exactly how long an exposure time you will need but, as a starting point, figure that there's a 50 percent increase in exposure time over lithographic film. But you'll have to experiment to find the best method for you. And once you find it, stick with it. Don't forget the "three C's" of making PC boards—care, cleanliness, and consistency.

Finally, we would like to hear how you make out using our method. Write and tell us of your successes, and failures, and what techniques work best for you. Address your letters to:

Radio-Electronics
Department PCB
500-B Bi-County Blvd.
Farmingdale, NY 11735

PC SERVICE

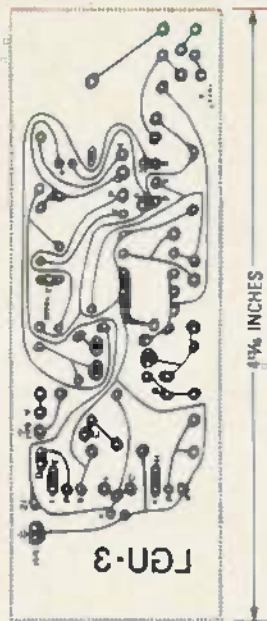

USE THIS board to build your laser.

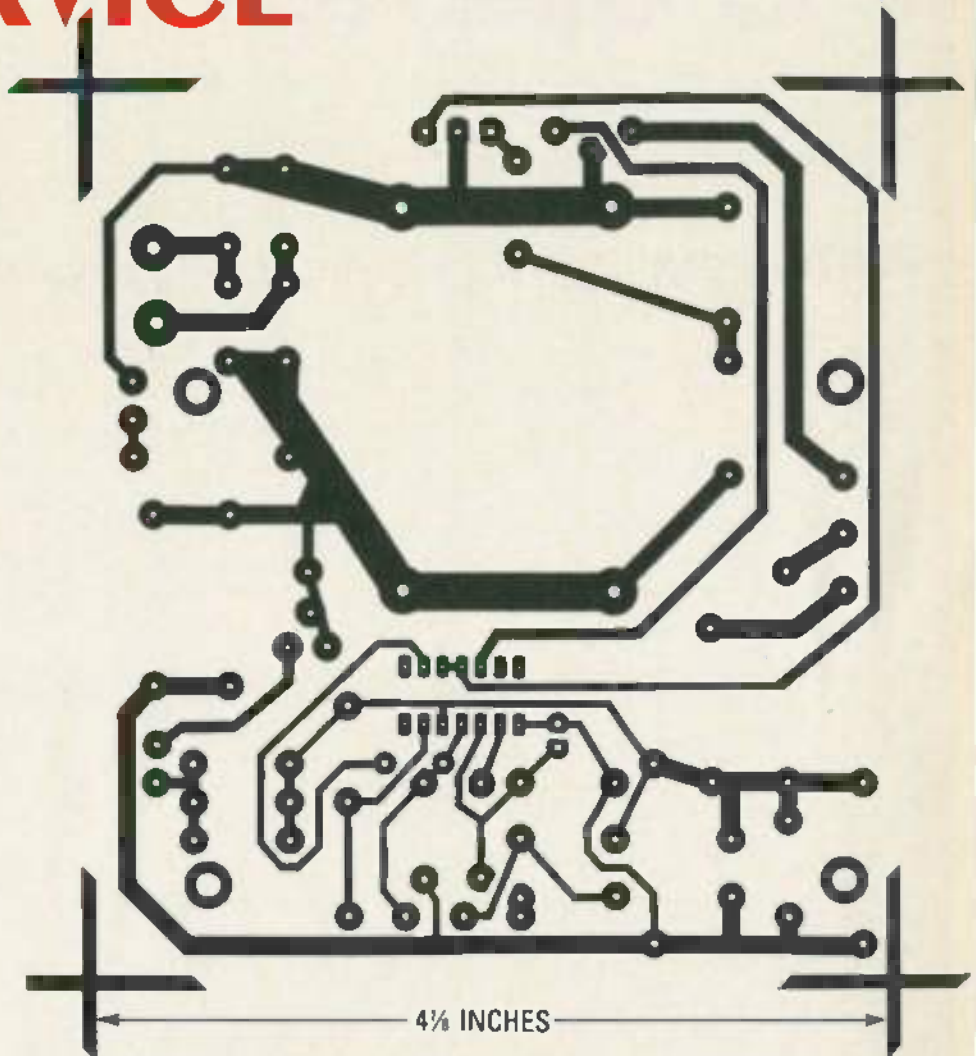

IF YOU WISH to etch your own board for the 30-volt power supply, use this pattern.

PC SERVICE

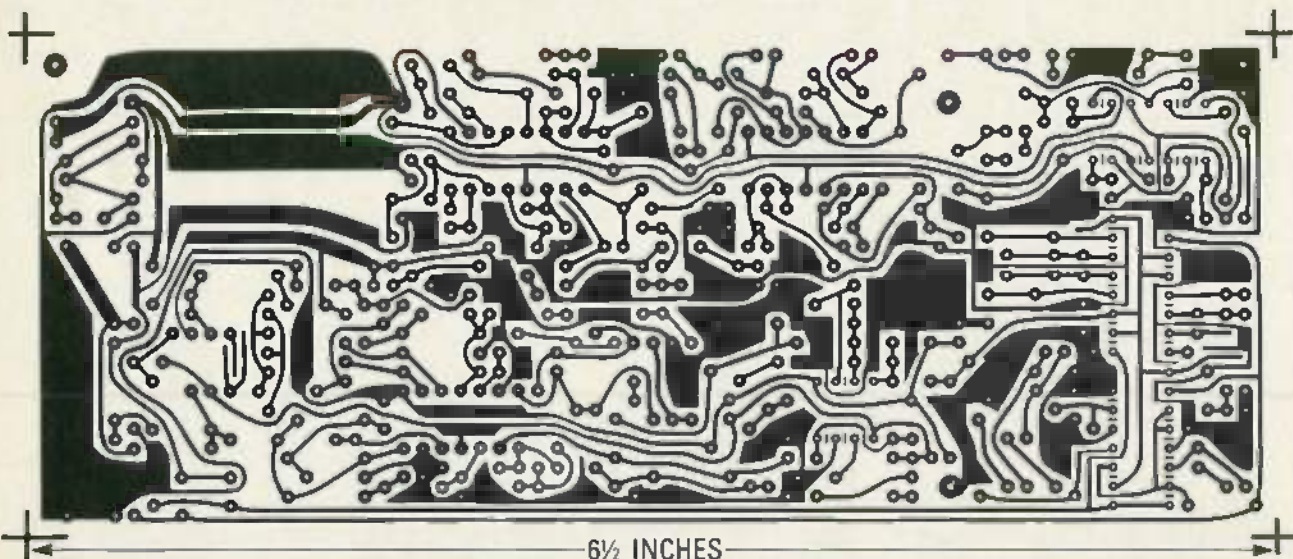

HERE'S THE FOIL PATTERN for our Click and Pop Filter.

DESIGNER'S NOTEBOOK

Precision rectifiers

WHEN YOU TALK ABOUT RECTIFIERS, THE first thing that comes to mind is power supplies, but rectifiers are also used in many other circuits. Converting AC to DC is necessary in many RF circuits, and most circuits that measure real-world quantities first have to rectify sensor voltages. But even though regular diodes and bridges are adequate for many rectifying jobs, sometimes a different approach is needed.

The rectifying circuit you build for a power supply will work perfectly well when you're eliminating batteries, but it will be completely useless for RF. The reason is simply that the input voltage is less than the voltage needed to turn a diode on. Even small-signal germanium diodes require about 0.3 volts to turn on. That may not seem like much, but, if you are working with signals in the millivolt range, you'll have to find another way to handle the problem.

Circuit designers have two standard methods of dealing with the situation. They can amplify the AC signal and then rectify it, or they can do both at once with a precision rectifier. All things considered, the latter method is a much better way to get the job done.

The one-step approach to building a precision rectifier requires some way of isolating the positive and negative halves of the incoming AC, but after that AC has been amplified to a usable level. The circuit shown in Fig. 1 is a straightforward way of combining both amplification and rectification.

I designed the circuit with a 741 op-amp since it is cheap and readily available. If the performance

specs of the 741 aren't to your liking, you can just as easily substitute any other op-amp. Higher input impedance, lower offset voltage, frequency limit, and slew rate are among the factors you should consider when choosing an op-amp. Examine the requirements of your application and choose an appropriate device.

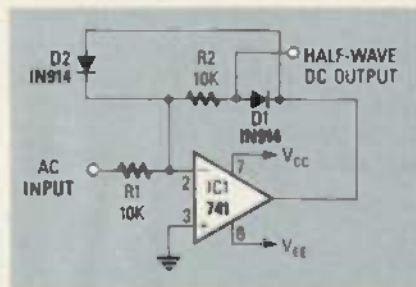

FIG. 1

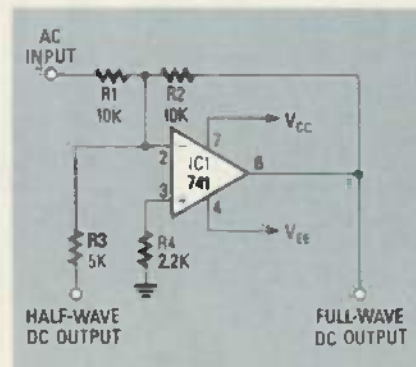

FIG. 2

How it works

The circuit's theory of operation is similar to that of a diodes-only rectifier. During the negative half of the AC cycle the output of the 741 forward biases D2 and current flows only through that diode. During the positive half of the input swing, however, D1 is forward-

biased, so current will flow through it and through R2. Therefore, DC will only show up across R2 during the positive part of the incoming AC cycle.

Because we're rectifying the voltage in the feedback loop of the op-amp and not at its input, the circuit will be able to handle very small AC signals. The inherent high gain of the op-amp allows us to rectify signals that are substantially below the voltage needed to forward-bias even small-signal germanium diodes.

The op-amp shown in Fig. 1 is set up as an inverting amplifier, so the output waveform will be 180° out of phase with the input. You could switch inputs on the op amp to turn it into a non-inverting amplifier, but the phase difference comes in handy if you want to build a precision full-wave rectifier.

A simple summing amplifier can be used to turn our circuit into a precision fullwave rectifier, but a bit of thought has to go into picking the summing resistors. As shown in Fig. 2, we're adding the original AC signal and twice the output of the halfwave rectifier discussed above.

If R1 and R3 (in Fig. 2) had the same resistance, the output of the halfwave rectifier and the negative half of the input AC would be equal in magnitude, but 180° out of phase. In other words, the net result would be a voltage of zero. We can solve that problem by mixing in twice the halfwave voltage.

If you decide to build the full-wave rectifier, it's a good idea to use a 747, which has two 741's in a single IC package. R-E



ROBERT GROSSBLATT
CIRCUITS EDITOR

STATE OF SOLID STATE



ROBERT F. SCOTT
SEMICONDUCTOR EDITOR

Single-chip sync/sweep circuit

A COMPLETE TELEVISION SYNC/SWEEP generator in a single IC package has been developed by RCA's Solid State Division. The CA3218E Vertical-Countdown Digital-Sync System is a significant advance over the sync and sweep circuits that have been recognized as industry standards for more than a decade. The IC is designed for operation in 525-line televisions, monitors, and video display equipment. The IC's unique vertical-countdown design uses a 10-stage counter and logic circuits to improve noise immunity and to permit elimination of the vertical-hold control.

The CA3218E also provides composite blanking and burst-gate output signals that can be summed in a simple external RC network to produce the "sandcastle" waveform signal needed for the operation of chroma and luminance circuits in color-TV receivers.

The device works with both standard and non-standard sync signals. An automatic mode-recognition circuit forces the IC to operate in the non-synchronous mode when the incoming composite video signal has a scanning rate other than the standard 60-Hz,

525-line format. The CA3218E might be used in a circuit like the one shown in Fig. 1.

How it works

The IC's internal master oscillator is controlled by an external RC network that is connected to pin 5. The oscillator runs at eight times the horizontal rate. The signal is divided several times and fed to other portions of the IC. For example, a divide-by-8 output goes to the horizontal amplifier output (pin 8). A phase-locking AFC circuit controls the precise frequency of the master oscillator.

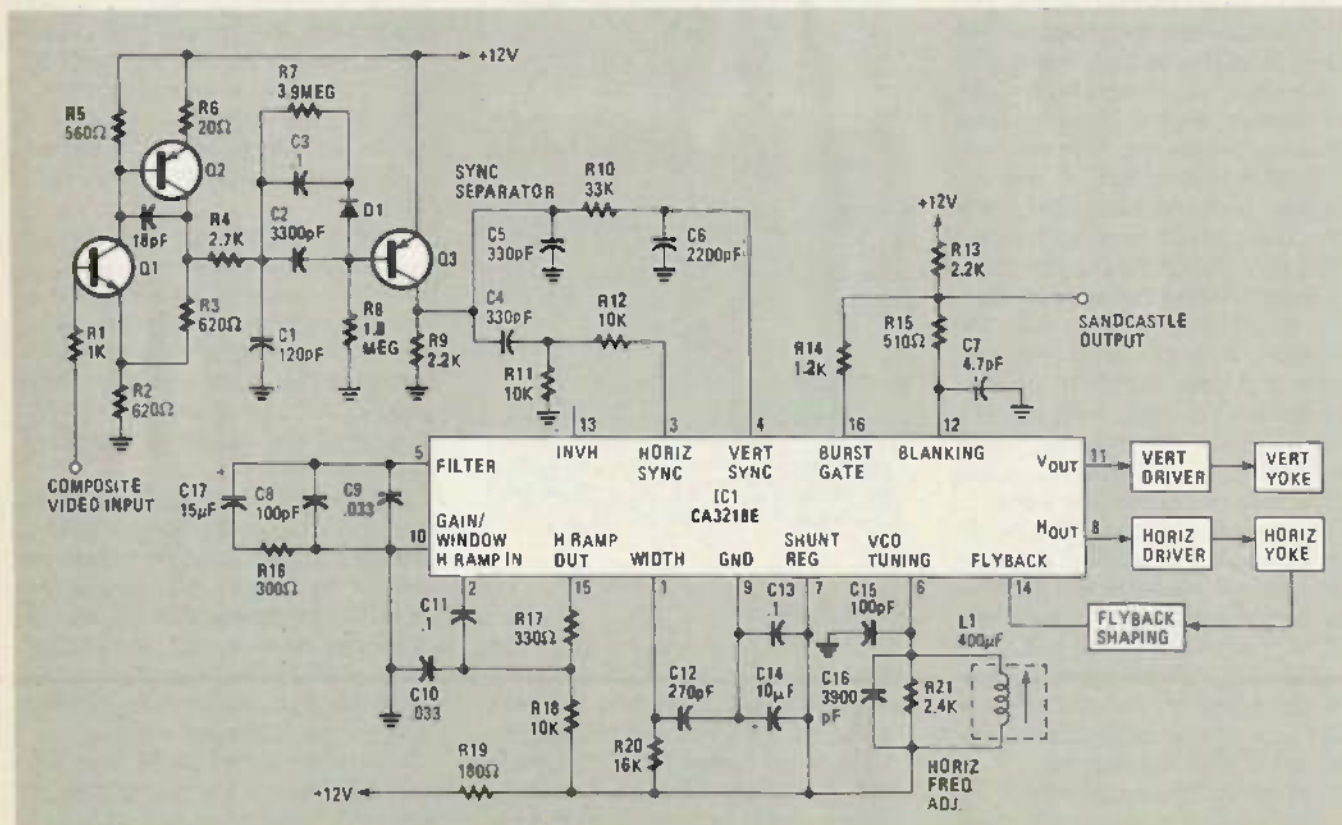

FIG. 1

The horizontal ramp signal input (pin 2) is derived from the flyback pulse that appears at pin 15. Then it's fed to a phase detector where it is compared to the horizontal sync fed in at pin 3. The phase detector generates a correction voltage that keeps the master oscillator phase-locked to the correct frequency.

Divide-by-2 and divide-by-4 outputs of the horizontal divider drive the 10-stage vertical counter. The digital countdown system and associated logic circuits provide good noise immunity and eliminate the need for a vertical-hold control.

The GAIN/WINDOW input (pin 10) is a logic input that controls the vertical-sync "window" during which the system looks for the occurrence of a vertical-sync pulse on the incoming signal.

Upon receipt of the 464th or the 512th clock pulse (according to whether pin 10 is low or high, respectively), the vertical-sync window is "opened." The end of the sync window is marked by the arrival of the 568th or the 592nd pulse, again according to whether pin 10 is high or low.

If the incoming vertical-sync pulse coincides regularly with the 525th clock pulse, vertical blanking and sweep signals are generated in the standard sync mode. If the incoming vertical sync does not coincide with the 525th clock pulse or if it is masked by noise, the 10-stage counter continues to supply an output at the 525th clock pulse. A three-bit counter counts the number of consecutive fields during which a sync pulse does not arrive simultaneously with the 525th clock pulse. If a sync pulse does not coincide with the 525th clock pulse for eight consecutive fields, the 3-bit counter activates a circuit that switches operation to non-standard sync.

When the circuit operates in the non-standard sync mode, the incoming vertical pulse initiates vertical sweep when the input pulse coincides with any clock pulse within the sync window except the 525th. If no vertical-sync pulse arrives during the window time, the system freewheels at a frequency determined by the 568th or 592nd clock pulse, depending on the state of pin 10.

The CA3218E generates a composite blanking signal and a burst-gate keying pulse at pins 12 and 16, respectively. Those signals can be summed in a simple external resistive network (R13, R14, and R15 in Fig. 1) to produce the "sandcastle" signal that is used to drive chroma/luminance IC's like RCA's CA3220E. The CA3218E also generates an inverted horizontal sync signal (at pin 13) that can be used to drive the CA3224E Automatic Picture Tube Bias IC.

The CA3218E costs \$2.00 each in 100-piece lots. For further information, and a copy of the data sheet (File No. 1637), write to RCA Solid State, P.O. Box 2900, Somerville, NJ 08876.

Power supply design aid

Ferranti Semiconductors has made available its Power Supply Design Pack that includes information on its Super E-Line, High-voltage Super E-Line, and MOSFET transistors. To receive the design pack, contact Ferranti Electric, Inc., 87 Modular Avenue, Commack, NY 11725.

Learn the IBM PC's secrets with the MICROPROFESSOR I/88



Students, engineers, or technicians—Now you can learn micro-processing and understand the technology which made the IBM PC famous.

- The MPF-I/88 features:
- extensive documentation
 - 16-bit central processor
 - full-size keyboard
 - special options

Three tutorial guides cover all capabilities. The ideal training tool! If the IBM PC or micro-processing are in your future, you owe yourself an MPF-I/88. Invest now!

Only \$349.95

Plus—

- Check this box for a FREE MPF-I/88 tutorial textbook when you order within 7 days. \$24.95 value

ETRONIX
Dept. RE 0686
5326 9th Ave. NE
Seattle, WA 98105-3617

For immediate action call TOLL FREE:
1-800-426-1044

Full money back guarantee.

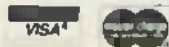

CIRCLE 178 ON FREE INFORMATION CARD

OK Test Equipment

OK
Electronics
Division

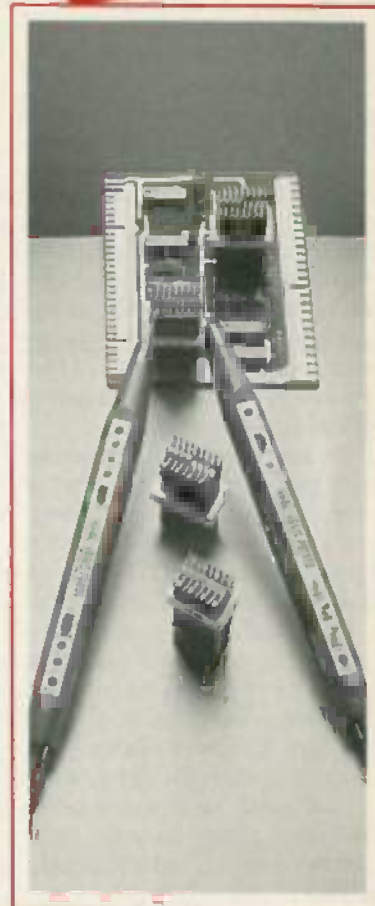

Probe & Pulser

The PRB-50 is a break through: high frequency response and multiple logic state indications at a very low price. Hi, Lo, Pulse, Open or Bad level indication with unambiguous LED displays are guaranteed to capture 80 MHz signals, 80 MHz is typical. Pulse memory latch, TTL or CMOS threshold switch and over/under voltage indication provide application flexibility. The PLS-500 pulser complements the logic probe, PRB-50. A single or continuous pulse is switch selectable. The SYNC OUT and EXT SYNC terminals allow triggering or triggered responses. PRB-50: DC to 80 MHz (80 MHz typical) • 10 nsec pulse response • Hi, Lo, Pulse indications • Automatic pulse stretching • Pulse latching memory • Switchable thresholds. PLS-500: Switchable 0.5 Hz/500 Hz rate • 2 usec pulse width • 1000 mA (1 amp) output • Automatic output voltage. Circuit powered. Detachable power cord.

AFFORDABLE EXCELLENCE

OK
Industries
Inc.

3455 Conner Street, Bronx, New York, 10475, U.S.A.
telex 125091 OK NYK telex 232395 OK NY UR.
Phone (212) 994-6600
Fax (212) 994-4755

CIRCLE 189 ON FREE INFORMATION CARD

JUNE 1986

73

ROBOTICS



MARK J. ROBILLARD,
ROBOTICS EDITOR

Pet robots?

WE'VE SPENT SEVERAL MONTHS DISCUSSING the hardware necessary to build robots. The most common applications for the type of robot we've been talking about include automatic assembly equipment and material transport. However, an entirely different type of application is emerging.

As anyone who has ever walked by a pet store can see, the pet industry in America is thriving. And the price for a well-bred dog can be astronomical. Why do people pay those prices? Companionship.

For example, a good dog is soft and furry, and he'll come to you when he is called. Left to himself, he'll fend for himself. Commanding him to speak yields a healthy bark. You can play fetch with him, and maybe he'll even bring the morning paper to you. Strangers will be sensed, "announced," and perhaps chased away.

To obtain those benefits all you have to do is provide a comfortable environment for your dog to live in. You must regulate the temperature, provide clean, fresh drinking water, and provide food. It doesn't hurt to clean your dog occasionally; otherwise you may find yourself caring for several dozen little pet insects as well.

What's all that got to do with robots? It appears, using technology that is available today, that it is possible to build a pet robot that can do most of the things we value our pet dog for. Of course there will be limitations. The robot won't be able to jump or catch a stick in mid air, but it could fetch the morning paper, provided the paper could be found in the same place every day. (And no pooper-scooper is required.—*Editor*)

A new company called Axlon (1287 Lawrence Station Rd., Sunnyvale, CA 94089) is first to apply robotics to the pet market. Their product is a "cat" named *Petster*. It is soft and furry, and it will come to you when you call. It purrs and its LED eyes blink. When you leave it alone, it finds a cozy place to relax and falls asleep. Clapping is used to communicate with the "beast."



FIG. 1

Sound too good to be true? It actually exists. I, and my family, which includes two girls, six and nine years of age, had the pleasure of testing one recently. Because the man-machine interface is not perfect, there are times when *Petster* does the opposite of what you command. But isn't that sometimes the case with a real pet? The limitations of the technology provide the unpredictability of a real pet.

Petster is based on a single-IC microprocessor that processes sounds picked up by its on-board microphone. Two small motors provide locomotion for the toy.

There is now a deluxe version available, shown in Fig. 1, that

purrs when you pet it, and that includes an electronic leash that allows you to take *Petster* for a walk. It can avoid obstacles picked up by an internal sensor. That's the same type of technology we've been talking about here.

A more serious use

Where will that technology lead? Another product recently announced by Axlon attempts to solve a problem of growing national concern. Thousands of children disappear each year. Those of you who are parents undoubtedly remember the sinking feeling you have when you are separated from your child in a shopping mall. And perhaps you have wondered whether a technological solution to the problem could be found.

Axlon's *S.O.S. Bear* is one attempted solution. Inside the bear is a radio transmitter that maintains contact with a receiver-alarm unit carried by the parent. If the child and the bear wander too far from the parent, the alarm sounds.

How far is too far? In a relatively quiet area such as a back yard or an open field, the unit allows a maximum separation of about fifty feet. But in a crowded shopping center, an internal sound-level detector automatically compensates and sounds the alarm when the distance between parent and child exceeds ten feet.

One problem with that scheme is this: What happens if the child and the bear are separated, as might happen in the case of a forced abduction? A solution might be to tether the bear to a battery pack attached to the child's clothing. Loss of the signal would then trigger the alarm. R-E

SATELLITE TV



BOB COOPER, JR.,*
SATELLITE-TV EDITOR

Black-box descrambling

SOME YEARS AGO A GROUP OF CLEVER college students dedicated themselves to learning how the long-distance telephone network works. Once they figured it out, they began building "blue boxes" with the capability of bypassing toll-call record-keeping systems. The magic boxes allowed a person to dial any number he or she wished, at any time, without incurring any long-distance charges. Naturally, many people enjoyed sticking it to Ma Bell, but Ma Bell lost a great deal of money and set out to discover what was happening.

Eventually the persons involved were caught, and, even though several publications had already printed complete descriptions of the circuitry involved, the practice all but died out. That's because the risk of discovery, and the penalties that could be incurred, were greater than the rewards that might be gained.

We now have a similar situation in TVRO. As reported last time, HBO and Cinemax began transmitting scrambled signals after the first of the year. The basic system is outlined in Fig. 1; note that, at the receiving end, the input to the descrambler can be either the 70-MHz output of a downconverter, or a baseband video signal. M/A-Com has designed different descramblers to handle both kinds of signal.

Since HBO and Cinemax began scrambling, Super Station WOR has joined the ranks of the scramblers; and more broadcasters will undoubtedly follow. As you might suspect, several firms and individuals have begun

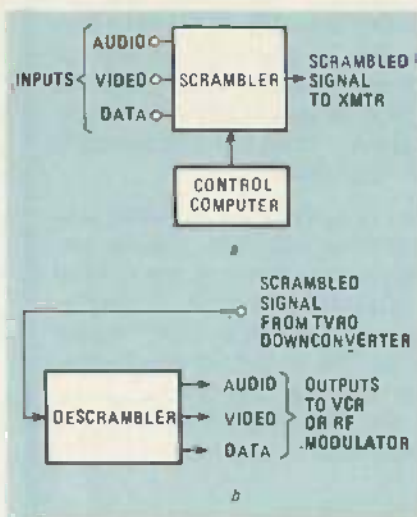

FIG. 1

working on breaking the scrambling system. Is that legal?

Cloudy legalities

The situation is unclear at this time. New telecommunications legislation was signed into law in the fall of 1984 by President Reagan; that legislation deals with the theft of telecommunication signals. What is considered theft? If you use a transmission that is private, and not intended for you, then under the new law you are stealing that communication.

In addition, the 1984 law considers you an accessory to such theft if you help someone else receive private signals, either by teaching him how to do it, or by providing him with equipment to do it. So, for example, if you figure out how to descramble the HBO satellite feed and share hardware or even information with a second party, you may be in violation of the law. Section 705 of the 1984 Communications Act provides for significant

financial penalties and possible imprisonment for violations. Further, the penalties are greater if you are involved in a theft-related business—such as building and selling descramblers.

Those potential penalties haven't deterred a few hardy souls. Advertisements are appearing that offer assembled descramblers as well as plans and kits of parts. The legality of those offerings has not been determined yet, but, as potential purchasers of descrambling products, you should be aware of the special circumstances involved here. The law was not very clear prior to the new legislation; it is more clear now than it was, but the courts have yet to test the new laws.

The technical end

To date, a number of interesting tricks have been offered to beat HBO's scrambling system. I'll describe several of the most common systems; they should serve as a warning, in case you're considering buying a black-box descrambler.

- A series of booklets are being sold, some for as much as \$50, that claim to disclose circuits that can beat the M/A-Com Videocipher scrambling system. I have read all the books I could get my hands on, and in no case does the solution offered descramble the audio signal. Video descrambling on HBO is really simple, since the polarity of the video waveform has been inverted, and the sync pulses have been retarded. All you have to do is re-invert the signal and regenerate the sync. And you don't have to buy a \$50 booklet to find out how to do that!

*Editor-in-Chief, Coop's Satellite Digest

● Kits, as well as wired and tested units, are being offered from a company in Canada. The company claims that you'll never have to pay a monthly fee for HBO after you purchase their descrambler. The kits are not yet available, and the wired and tested unit we saw was simply a M/A-Com Videocipher circuit mounted in a different cabinet to disguise its origins.

Cleverly, the company enrolls the subscriber in HBO's normal service for several months. When

that subscription lapses the user is left with a descrambler that works like the legitimate M/A-Com descramblers: when you pay for service, you'll be able to receive descrambled signals.

● Circuit wizards are looking into modifying the specially-encoded IC's in each Videocipher so that you can bypass HBO's scrambling permanently. I don't know if such "bypassing" is indeed possible, but I'd be shocked if M/A-Com left such a gaping hole in their security

IF YOU need to know the latest status of satellite TV scrambling, call this number for a free informational update of SCRAMBLE-FAX[™] from Bob Cooper's CSD Magazine. Twenty-four hours per day, you can find out the latest information concerning which services are scrambling, the type of scrambling system being utilized, plus the availability and source/pricing for descrambler units. SCRAMBLE-FAX[™] has been designed to help end the confusion over satellite TV scrambling.

SCRAMBLE-FAX[™] helps you as a retailer or heavy user of TVRO stay abreast of the fast-changing satellite scrambling evolution. These constantly updated audio news reports capsule into a three minute call the latest inside information on scrambling. SCRAMBLE-FAX[™] 'Audio Reports' are compiled from the pages of the **SCRAMBLE-FAX[™] News Bulletin** printed reports now being issued by CSD Magazine on a routine basis. SCRAMBLE-FAX[™] 'Audio Reports' are intended to supplement the comprehensive written reports in the SCRAMBLE-FAX News Bulletin[™] from CSD Magazine, but are available to anyone capable of dialing 305-771-0575.

OR ORDER your own SCRAMBLE-FAX News Bulletin[™] today by completing the coupon below OR with your VISA or Mastercharge card handy, call 305-771-0505 for your AIRMAIL copy of SCRAMBLE-FAX News Bulletin[™]. The 'Bulletin' provides concise data on everything from receiver test data for Videocipher descrambler compatibility to insider reports on black box descramblers and satellite service scrambling schedules and progress. The SCRAMBLE-FAX News Bulletin[™] is issued periodically in updated form and is sold to you on a per-copy basis with convenient order form for the next updated issue. Users however are assured of a constantly self-updating format by using the SCRAMBLE-FAX telephone 'hotline' service at 305-771-0575.

SEND ME SCRAMBLE-FAX NEWS BULLETIN!

_____ \$10 enclosed (check or money order) for the latest AIRMAIL transmitted SCRAMBLE-FAX News Bulletin.

Charge my _____ VISA _____ Mastercharge card number _____, expiring _____

\$10 and send the latest SCRAMBLE-FAX News Bulletin via AIRmail.

My Name (as it appears on VISA/Mastercharge card if applicable) _____

Address _____

Town _____ State _____ Zip _____

Order From: CSD Magazine, P.O. Box 100858, Ft. Lauderdale, Fl. 33310
305/771-0505 weekdays from 9AM to 4PM Eastern.

**305-
771-
0575**

Call It!

Interested in TVRO?

For nearly two years Bob Cooper has provided a no-charge kit of printed materials that describes the challenges of and opportunities in selling TVRO systems today. With the present intense interest in scrambling systems, Coop's CSD has made available a new no-charge service.

The SCRAMBLE FAX hotline is a 24-hour-per-day telephone service that provides accurate, detailed, and hard-to-find facts concerning the changeover to scrambling in the satellite communications industry. Information describing satellite receivers tested for scrambling compatibility, sources for authorized descramblers, wholesale rates of scrambling equipment and services—all are provided on the SCRAMBLE FAX hotline. There is no charge for that service, other than your long-distance telephone expenses. Simply dial (305) 771-0575 for a concise and timely three-minute capsule report that covers the latest in scrambling news.

system; it's an open invitation to being cracked.

It seems that vendors of presently-available non-authorized descramblers are vultures preying on people's desire to get something for nothing from HBO and from other programmers. In fact, it's such an emotional issue that people who normally exhibit good, common buying sense are throwing caution to the winds and buying anything that promises to beat the system. But, as I write this, I have yet to see any gadget or circuit that will recover both the scrambled video and the scrambled audio from either the M/A-Com Videocipher or the Oak Orion descrambling systems.

So, spend your money wisely, and if you like to play with challenging new technology, have at it. Who knows, you could be the first to break the digital audio scrambling system that is the current rage in commercial telecommunications! **R-E**

This publication is available in microform from University Microfilms International.



Call toll-free 800-521-3044. In Michigan, Alaska and Hawaii call collect 313-761-4700. Or mail inquiry to: University Microfilms International, 300 North Zeeb Road, Ann Arbor, MI 48106.

satellite TV week

Try us once and you'll know why
we're the best satellite
TV program guide you can buy ...

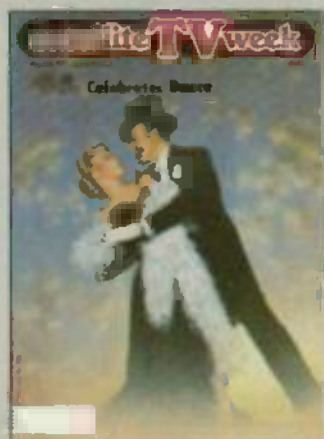

Request a **free** sample today!

Let us be your guide to better accuracy of weekly listings for
over 100 channels, better movie information, more sports
coverage, financial advice, world news, arts and entertainment.

Let us be your guide to world-wide entertainment.

Fill out this coupon to receive your free copy of Satellite TV Week.

satellite TV week

Please enter my subscription order today.

2 years (104 issues) ... \$89 1 year (52 issues) ... \$48

1 year Alaska, Hawaii, Puerto Rico, Mexico, Canada \$100 US

Payment enclosed Please advise foreign rates

Visa MasterCard Exp. Date _____

Card No. _____

Signature _____

Send my free sample today!

NAME _____

ADDRESS _____

CITY _____

STATE _____ ZIP _____

TELEPHONE (_____) _____

Mail this coupon to **SATELLITE TV WEEK**, P.O. Box 308, Fortuna, CA 95540, or
for immediate service, call **TOLL FREE 800:358-9997 (US)/800:556-8787 (CA)/707:725-2476 (Others)**.

H2502

CIRCLE 184 ON FREE INFORMATION CARD

PRINT™

Products International Inc.

★ ★ NEW from Products International ★ ★

FREE CATALOG

- Equipment, Tools & Supplies for Electronic Maintenance & Service.
- Test Oscilloscope and Probe Cables
 - Solder Paste Products
 - All Wave Soldering Products, Vapors
 - Soldering Irons and Stands
 - Handheld Soldering Irons
 - Longwave Hand Tools
 - Solder Tray Covers
 - Control Tap Cables, Wires, Connectors
 - Solder Heat Tapes and Strippers for Repair in the Field or Shop

Call Our Toll Free Number
In Maryland
Call 301-587-7824

800-538-2020



PAGE INCORPORATED

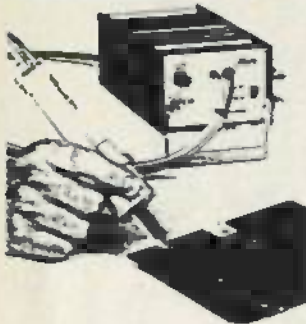

MP-1

MICROPORTABLE
DESOLDERING AND SOLDERING SYSTEM

REG

\$395.00

SALE

\$349.00

1129 Greenway Road • Silver Spring, Maryland 20910 • 301-587-7824 800-538-2020

CIRCLE 187 ON FREE INFORMATION CARD



This publication is available in microform.

University Microfilms International reproduces this publication in microform: microfiche and 16mm or 35mm film. For information about this publication or any of the more than 13,000 titles

we offer, complete and mail the coupon to: University Microfilms International, 300 N. Zeeb Road, Ann Arbor, MI 48106. Call us toll-free for an immediate response: 800-521-3044. Or call collect in Michigan, Alaska and Hawaii: 313-761-4700.

Please send information about these titles:

Name _____
Company/Institution _____
Address _____
City _____
State _____ Zip _____
Phone () _____

University
Microfilms
International

WM. B. ALLEN'S HITACHI SELL-A-BRATION

OSCILLOSCOPES

V-212
DC-20MHz • Dual Trace



Reg. \$615

\$425

V-222
20MHz • Dual Trace
6" CRT



Reg. \$715

\$490

OPEN SATURDAYS UNTIL 1:00 P.M.
24 HOUR ANSWERING

**WM. B. ALLEN
ELECTRONICS
CATALOG
FREE
WITH EVERY
PURCHASE**

928 PAGES
\$15.00 VALUE



V-422
DC-40MHz • Dual Trace



Reg. \$925

\$624

V-1050
100MHz • Quad Trace
Delayed Sweep



Reg. \$1595

\$1150

V-650F
60MHz • Dual Trace
Delayed Sweep



Reg. \$1195

\$870

V-1100
100MHz • Quad Trace
CRT Readout • 1mV
6" PDA-CRT



Reg. \$2490

\$2190

V-1070
100MHz • Quad Trace
CRT Readout
6" PDA-CRT



Reg. \$2295

\$1249

V-8041
40MHz/2 Channels • 4000
Words Per Channel



Reg. \$5855

\$4350

WM. B. ALLEN SUPPLY COMPANY

ALLEN SQUARE

300 BLOCK NORTH RAMPART, NEW ORLEANS, LA 70112

800 535-9593

LOUISIANA 800 462-9520

CIRCLE 103 ON FREE INFORMATION CARD

ASK R-E

continued from page 8

surge can cause an annoying 120-hertz buzz on nearby AM radios, and it may interfere with the operation of some types of electronic equipment.

For example, consider the high-current incandescent lamps that are used in traffic-control signals and movie projectors. When power is applied at any instant other than the zero-crossing, the lamp's filament is cold and its resistance is low. The resulting inrush of current is typically ten to twenty times the steady-state value.



FIG. 1

Further, thyristors (SCR's and Triacs) used in solid-state relays, electronic light dimmers, heater controls, and small-appliance speed controls vary applied power by varying the phase angle over which that power is applied. When power is applied to the device for a period less than 180 degrees, the load current rises abruptly, and that may shorten the life of the thyristor, as well as that of the controlled device. Radio-frequency interference may also occur.

Those problems are reduced or eliminated by using a zero-voltage switch. Those devices are used in a variety of products, including the BSR remote control system. Typical switches now come in IC form, like the CA3059, available from RCA and Motorola, TI's TL4400, and the OPI3030 series from TRW Optron. The latter include optoisolators in addition to the zero-voltage switch.

R-E



MEGURO
MADE IN JAPAN

3½-DIGIT AUTORANGING MULTIMETERS

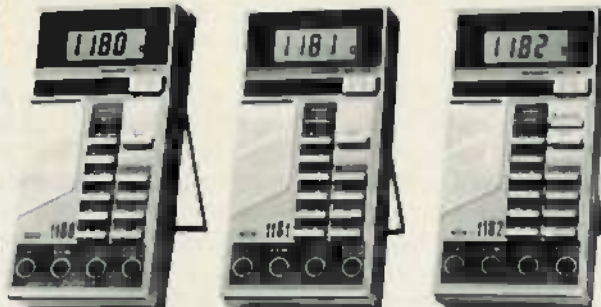

MDM-1180

~~\$79.95~~
\$39.95

MDM-1181

~~\$99.95~~
\$65.95

MDM-1182

~~\$99.95~~
\$53.95

FEATURES:

- Automatic and Manual Ranging Selectable (except current measure.)
- Large and High Contrast LCD
- Custom and Power Saving ICs:
500 hours on just two AA-Batteries
- Accuracy (DC Volt): MDM-1181 0.1%,
MDM-1182 0.25%, MDM-1180 0.7%
- Data Hold Function (MDM-1182 only)
- 9 Measurement Functions
- 2 AA-size Batteries, Safety
Measurement Leads and Fuse Included
- ONE YEAR WARRANTY
- QUANTITY LIMITED

■ PLEASE ADD FOR SHIPPING AND INSURANCE

•MULTIMETER:

\$39.00-\$250.00: \$4.50/\$251.00-\$600.00: \$6.50
\$601.00-\$750.00: \$8.50/\$751.00-\$1,000.00: \$12.50
\$1,000.00 and more: \$15.00

■ WE ACCEPT ONLY MONEY ORDERS OR CHECKS TO SAVE YOUR COST.

■ PLEASE ADD 6.5% FOR TAX (CA ONLY)

HI-SHURE CORP.

TOLL FREE 1-800-222-7798

1050 E. DOMINGUEZ ST.

CARSON, CA 90746

(213) 637-1863

RE 5

ANTIQU RADIOS



RICHARD D. FITCH
CONTRIBUTING EDITOR

Automatic tuners

YOUNG COLLECTORS OF ANTIQUE RADIOS may be a little surprised at how advanced some early receivers were. Many modern "innovations" are actually just ideas that were already popular in the early days of radio. For example, the automatic tuning systems used on radios of the 1930's and afterwards provided much convenience for early listeners. By way of contrast, you old-timers might remember having to tune each of four huge dials separately, and possibly several smaller dials.

That's the way it was at first, but improvements came fast. Soon it became possible to control all those dials with a single knob. Next pushbutton-selection of stations became popular. As the 1930's progressed, at least half a dozen types of automatic tuners became available. Our antique of the month presents one novel approach to the two-hands-too-few problem; after discussing it, we'll talk about other approaches.

The Grunow Model 588

The beautiful set shown in Fig. 1 is a superhet that covers the broadcast band and one shortwave band. Band-selection is accomplished by the center knob in the group of three. Another knob is a tone control. The tuning dial is what makes this radio interesting; it's called a *Teledial*, and it's a manually-operated automatic tuner that made its appearance in the mid 1930's. Later on, similar arrangements were motorized.

It's called a *Teledial* because it works like a rotary telephone dial. You push a button on the circum-

ference of the tuning dial and then rotate the dial until it latches. You could set as many as eight different "stops" on the model 588. The buttons are set by tuning in the desired station, moving the button to the latch gate, and then tightening the button.



FIG. 1

Against my better judgement, I removed the entire tuning device to see how it works. Removing one hex nut on the mounting bracket loosened the entire assembly and revealed the efficient dial lamp in the center of the dial. The lamp is accessible by removing the dial pointer. It's easy to string the dial cord. The latch-gate stops are mounted on steel springs which retract as the pin passes over the wedge. Some motorized tuners use a similar arrangement.

The Grunow model 588 has five tubes, including an 80 rectifier, a 6A7 first detector and oscillator, a 6D6 IF Amplifier, a 75 second detector, AVC and audio pre-amp, and, finally, a 41 power output tube. The set has an IF of 465 kHz, a built-in power transformer, and connections for an antenna and ground, and it uses a dynamic speaker.

Similar tuners were made by

Emerson, Fairbanks, Morse, Philco, Traveler, Erla, Wilcox Gay, and General Household Utilities, who made the Grunow.

Pushbutton Tuners

Of course, the *Teledial* is not the only type of automatic tuner; probably most popular was the mechanical pushbutton type, which can itself be broken down into several different types. Pushbutton tuners often use one switch to control power and another to select a shortwave band, which could then be tuned with the regular tuning dial. A pushbutton system like the one on some Trutone models was about the simplest and least expensive. It uses a system of levers and springs that actually turns the ganged tuning capacitor. It's easy to build and adjust, but it requires considerable pressure to operate the buttons.

Philco manufactured one radio that requires less button pressure than the Trutone. It works by disengaging the ganged tuning capacitor when the pushbuttons are in use. The switching arrangement then connects a different coil in the circuit when the button is pushed. The adjusting screws of those coils are accessible from the back of the cabinet. The only problem is that, if a set is tampered with, it could take a technician a full day to align all those coils.

The Belmont Model 5D128, which was our Antique of the Month last time, has a mechanical pushbutton arrangement called the "Belmonter." The buttons make chassis removal a little tricky.

You have to to remove the tuning knob, which is always on the side of the cabinet with this type of tuner, before removing the chassis.

WARNING: Don't try to pry the tuning knob off in the usual manner. You'll break it, and then you'll have to glue it back together. There is a screw through the center of the knob that is covered by a decal or possibly by some sort of slug. That screw must be removed first. Then you can unscrew the chassis bolts, remove the volume control knob and then remove the chassis. Of course, it's not necessary to remove the chassis just to tune up the push buttons. Just loosen the tuning knob's lock screw and you'll have no problem.

The tuning system works like this. There are five heart-shaped cams mounted on an extended ganged-tuning shaft. Pushing a button causes the roller part of the mechanism to rotate the cam until the roller part falls into the low spot on the cam. To set a button for a particular station, the station is tuned in with the tuning dial while holding down the button. Then the locking screw is tightened.

Belmont's pushbuttons require less operating force than many others, due to the elimination of the leverage devices, and to rotating the cams directly against the shaft of the tuner shaft. It's interesting to note that pushing the buttons of many automatic tuners actually requires more physical effort than simply rotating the tuning dial!

Here's a few hints on how to set up a pushbutton tuner in an antique radio. Select only strong stations with low noise levels. Also, select stations that don't drift or fade. And any receiver that is prone to frequency drift should be serviced before attempting to set up the automatic tuning system. Last, let the set warm up for at least ten minutes before attempting to set up the automatic tuner. Otherwise the station is liable to drift, so your work will have been in vain.

Motor drive

For those who didn't want to expend the energy necessary to operate a pushbutton tuner, and whose pocketbooks could afford

an alternative, there were motor-driven and motor-assisted tuners. Among others, Gilfillan, Zenith, Stromberg-Carlson, United American Bosch, and Crosley manufactured motorized tuners.

Motorized tuners were available in several variations depending on whether the pushbuttons or the tuning dial was motorized. With some, it was necessary to fine-tune the station after letting the motor do its thing. Provisions were made for muting the audio output while the motor was operating so that no objectionable noise would bother the listener.

One thing all automatic tuners have in common is that they are designed for easy use by the consumer. Adjusting the tuning buttons was easy with the *Teledial*, for example. Even systems like the Belmont that require a little effort could be used easily by the average consumer.

Service hints

Adjusting the automatic tuning mechanism should be done only after the set functions normally.

continued on page 87

SUPER LONG PLAY TAPE RECORDERS

10 Hour Model — \$95.00*
14 Hour Model — \$159.00*

Modified Panasonic Slimline. high quality AC-DC Recorders provide 5 or 7 continuous hours of quality recording & playback on each side of cassette for a total of 10 or 14 hours depending on model. Built-in features include • Voice level control • Digital counter, etc. TDK DC 180 Cassette Furnished.

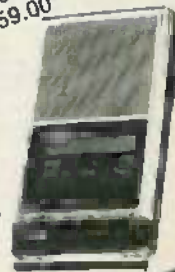

PHONE RECORDING ADAPTER

Records calls automatically. All Solid state connects to your telephone jack and tape recorder. Starts recording when phone is lifted. Stops when you hang up. \$24.50*
FCC APPROVED



VOX VOICE ACTIVATED CONTROL SWITCH

Solid state. Self contained Adjustable sensitivity. Voices or other sounds automatically activate and control recorder. Uses either recorder or remote mike. \$24.95*

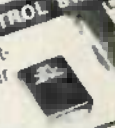

*Add for ship & hdg. Phone Adapter & Vox \$1.50 ea. Recorders \$4.00 ea. Cal. Res. add tax. Mail order, VISA, M.C., COD's OK. Money Back Guarantee. Qty. disc avail. Dealer Inquiries Invited, Free data. AMC SALES INC. Dept. A 93351 ubcc St., Box 928, Downey, CA 90421 (213) 858-8518

CIRCLE 108 ON FREE INFORMATION CARD

OUR 20 YRS.

of manufacturing quality crystals for the industry, military services, radio amateur and citizens band and experimenters

IS YOUR ASSURANCE OF STABILITY

TO SAVE MONEY GET THIS FREE CATALOG

Call or Write **JAN CRYSTALS**
P.O. Box 06017
Fort Myers
FL 33906-6017
(813) 936-2397

Since 1965

CIRCLE 104 ON FREE INFORMATION CARD

Be an FCC LICENSED ELECTRONIC TECHNICIAN!

Earn up to \$30 an hour and more!

Learn at home in spare time. No previous experience needed.

No costly school. No commuting to class. The Original Home-Study course prepares you for the "FCC Commercial Radio-telephone License". This valuable license is your "ticket" to thousands of exciting jobs in Communications, Radio-TV, Microwave, Computers, Radar, Avonics and more! You don't need a college degree to qualify, but you do need an FCC License.

No Need to Quit Your Job or Go To School
This proven course is easy, fast and low cost! **GUARANTEED PASS** - You get your FCC License or money refunded. Send for **FREE** facts now. **MAIL COUPON TODAY!**

COMMAND PRODUCTIONS
FCC LICENSE TRAINING, Dept. 90
P.O. Box 2223, San Francisco, CA 94126
Please rush **FREE** details immediately!

NAME _____
ADDRESS _____
CITY _____ STATE _____ ZIP _____

JUNE 1986

MARKET CENTER

SATELLITE TV

STEREO TV adapter kit Easily converts any TV/VCR to receive the new stereo TV sound. Contains all parts PCB and instructions to build a quality stereo decoder. For additional information send SASE to **SOŁOWSKI**, Box 150, Elmont, NY 11003.

MULTI-channel microwave TV antennas—lifetime warranty—complete 20" dish system \$89.95. Buy direct from the manufacturer—replacement components and "Build It Yourself" kits available. Discount quantity pricing—dealers welcome. Call or write for free information package—**K&S ELECTRONICS**, P.O. Box 34522-RE, Phoenix, AZ 85067. (602) 230-0640 Visa/MasterCard/COD's.

SATELLITE systems... Lowest prices in the nation! Send Brand, Model to: **2002 INNOVIA, INC.**, Box 2002, Gardnerville, NV 89410. (800) 628-2828 ext. 519.

CLASSIFIED AD ORDER FORM

To run your own classified ad, put one word on each of the lines below and send this form along with your check to:

Radio-Electronics Classified Ads, 500-B Bi-County Boulevard, Farmingdale, NY 11735

PLEASE INDICATE in which category of classified advertising you wish your ad to appear. For special headings, there is a surcharge of \$23.00.

{ } Plans/Kits () Business Opportunities () For Sale
{ } Education/Instruction () Wanted () Satellite Television

Special Category: \$23.00

PLEASE PRINT EACH WORD SEPARATELY, IN BLOCK LETTERS.

(No refunds or credits for typesetting errors can be made unless you clearly print or type your copy.) Rates indicated are for standard style classified ads only. See below for additional charges for special ads. **Minimum: 15 words.**

1	2	3	4	5
6	7	8	9	10
11	12	13	14	15 (\$42.75)
16 (\$45.60)	17 (\$48.45)	18 (\$51.30)	19 (\$54.15)	20 (\$57.00)
21 (\$59.85)	22 (\$62.70)	23 (\$65.55)	24 (\$68.40)	25 (\$71.25)
26 (\$74.10)	27 (\$76.95)	28 (\$79.80)	29 (\$82.65)	30 (\$85.50)
31 (\$88.35)	32 (\$91.10)	33 (\$94.05)	34 (\$96.90)	35 (\$99.75)

We accept MasterCard and Visa for payment of orders. If you wish to use your credit card to pay for your ad fill in the following additional information (Sorry, no telephone orders can be accepted.):

Card Number

Expiration Date

Please Print Name

Signature

IF YOU USE A BOX NUMBER YOU MUST INCLUDE YOUR PERMANENT ADDRESS AND PHONE NUMBER FOR OUR FILES. ADS SUBMITTED WITHOUT THIS INFORMATION WILL NOT BE ACCEPTED.

CLASSIFIED COMMERCIAL RATE: (for firms or individuals offering commercial products or services) \$2.85 per word prepaid (no charge for zip code)...**MINIMUM 15 WORDS.** 5% discount for same ad in 6 issues; 10% discount for same ad in 12 issues within one year; if prepaid. **NON-COMMERCIAL RATE:** (for individuals who want to buy or sell a personal item) \$2.30 per word, prepaid...no minimum. **ONLY FIRST WORD AND NAME** set in bold caps at no extra charge. **Additional bold face** (not available as all caps) 50¢ per word additional (20% premium). **Entire ad in boldface**, add 20% premium to total price. **TINT SCREEN BEHIND ENTIRE AD PLUS ALL BOLD FACE AD:** add 25% premium to total price. **TINT SCREEN BEHIND ENTIRE AD PLUS ALL BOLD FACE AD:** add 45% premium to total price. **EXPANDED TYPE AD:** \$4.30 per word prepaid. All other items same as for **STANDARD COMMERCIAL RATE.** **TINT SCREEN BEHIND ENTIRE EXPANDED TYPE AD:** add 25% premium to total price. **TINT SCREEN BEHIND ENTIRE EXPANDED TYPE AD PLUS ALL BOLD FACE AD:** add 45% premium to total price. **DISPLAY ADS:** 1" x 2 1/4" — \$310.00; 2" x 2 1/4" — \$620.00; 3" x 2 1/4" — \$930.00. **General Information:** Frequency rates and prepayment discounts are available. **ALL COPY SUBJECT TO PUBLISHERS APPROVAL. ADVERTISEMENTS USING P.O. BOX ADDRESS WILL NOT BE ACCEPTED UNTIL ADVERTISER SUPPLIES PUBLISHER WITH PERMANENT ADDRESS AND PHONE NUMBER.** Copy to be in our hands on the 12th of the third month preceding the date of the issue. (i.e., August issue copy must be received by May 12th). When normal closing date falls on Saturday, Sunday or Holiday, issue closes on preceding working day.

BLACK BOX DE-SI-FURING THE SOLUTION TO SATELLITE SCRAMBLING VOL. II

AMERICAN AND CANADIAN

Latest Satellite Technology available. Over 100 pages of how to build. Comes with complete schematics. Parts lists and suppliers of parts & kits.

\$29.95
BLACK BOX
DE-SI-FURING
THE SOLUTION
TO SATELLITE
SCRAMBLING

CONTENTS OF MANUAL

- 4 different types of satellite scrambling
- Modes of operation
- How to build a De-Si-Fur
- Digital audio & CRT controllers
- Digital audio processors
- Schematic dia

To order this manual, please money order only for \$29.95 plus \$3.00 shipping & handling charge. COD's please. Thank you. BELLAIRE DIST. CO., P.O. Box 41, Warren, NJ 02605.

BUILD your own satellite TV receiving system and save! Instruction manuals, schematics, circuit board, parts kits! Send stamped envelope for complete product listing: **XANDI**, Box 25647, Dept. 21B, Tempe, AZ 85282.

CABLE TV Secrets—the outlaw publication the cable companies tried to ban. HBO, Movie Channel, Showtime, descramblers, converters, etc. Suppliers list included. \$8.95. **CABLE FACTS**, Box 711-R, Pataskala, OH 43062.

CABLE TV Source Book—a complete listing of suppliers for hard-to-find converters, descramblers, technical information, schematics and much more. Full refund if not satisfied. Send \$4.95 to **CABLE**, Box 12505-R, Columbus, OH 43212.

SCIENTIFIC—Atlanta cable systems! See all the channels. 8500 series. Complete boxes, descramblers, hand remotes... Send \$2.00 **ADVANCED TECH. SYSTEMS**, Box 316, Auburn, MA 01501. (617) 832-2339.

SATELLITE systems \$449 Catalog \$2 also: KU band systems. **STARLINK, INC.**, 2603-16R Artie, Huntsville, AL 35805.

59 degree LNA's! Brand name! Improve your satellite system! Convert block systems to KU-Band. Replacement LNB's. Discount pricing: **LNA**, 201 E. Southern, Suite 100B, Tempe, AZ 85282.

MASTERCARD AND VISA are now accepted for payment of your advertising. Simply complete the form on the first page of the Market Center and we will bill.

PAY TV and Satellite Descrambling

73 pages of theory and schematics for all major systems. Fantasy and Anek-D schematics included. Most complete reference available on satellite scrambling \$12.98. MDS Handbook \$10. Stungun schematics \$5. Satellite systems under \$600. \$11.98. Printed circuits, kits catalog \$1.

SHOJWA ELECTRONICS CORP. 1327R Niagara Street, Niagara Falls, NY 14303. COO's 716-284-2163

WANTED

INVENTORS! AIM wants—ideas, inventions, new products, improvements on existing products. We present ideas to manufacturers. Confidentially guaranteed. Call toll free 1-800-225-5800 for information kit.

INVENTIONS, ideas, new products wanted! Industry presentation/national exposition. Call free 1-800-528-6050. Canada, 1-800-528-6060. X831.

BUY BONDS

BUSINESS OPPORTUNITIES

MECHANICALLY Inclined individuals desiring ownership of small Electronics Manufacturing Business—without investment. Write: **BUSINESSES**, 92-R, Brighton 11th, Brooklyn, NY 11235.

YOUR own radio station AM, FM, TV, Cable. Licensed/unlicensed. **BROADCASTING**, Box 130-F4 Paradise, CA 95969.

RECOVER silver from home and industrial junk. Free silver with my \$10.00 booklet of items that contain silver. **CON FOWLER**, Box 4401, Cleveland, TN 37311.

ESTABLISHED mail order company seeking new products and devices. Submit description and details: **SOMMER ENTERPRISES** Box 323 Station "S," Toronto, Ontario, Canada M5M-4M9.

FANTASTIC Opportunity nutritious food MLM send \$5.00 **DINNER APPLICATION**, Box 694, Valley Stream, NY 11581.

INVENTORS for under \$20. You can protect your idea. Call 718-471-6614. Call Steven.

BIG PROFITS

ELECTRONIC ASSEMBLY BUSINESS

Start home spare time investment knowledge or experience unnecessary. **BIG DEMAND** assembling electronic devices. Sales handled by professionals. Unusual business opportunity.

FREE: Complete illustrated literature
BARTA, RE-O Box 248
Walnut Creek, Calif. 94597

PLANS AND KITS

CATALOG: Hobby/broadcasting/1750 Meters/Ham CB: Transmitters, amplifiers, antennas, scramblers, bugging devices, more! **PANAXIS**, Box 130-F4 Paradise, CA 95969.

CABLE TV converters: Jerrold products include "New Jerrold TRI-MODE," S-8-3, Hamlin, Dak VN-12, M-35-B, Zenith, and more. UHF Deluxe II kills. (quantity discounts) 60 day warranty. Service converters sold here. For fast service COD orders accepted. Send SASE (60 cents postage) or call for info. (312) 637-4408. **HIGGINS ELECTRONICS**, 5143-R W. Diversey, Chicago, IL 60639. No Illinois orders accepted.

HI-FI speaker systems kits, auto speaker systems and speaker components from the world's finest manufacturers. For beginners and audiophiles. Free literature. **A&S SPEAKERS**, Box 7462R, Denver, CO 80207. (303) 399-8609.

8" DISH \$69 fabrication cost. Polar mount, attractive, easy construction. Stock hardware items used. Complete instructions, plans, fabrication, assembly, setup, drawings, photos. \$14.95 Plus \$2.00 shipping. **DIRIJO DISH**, Box 212, Lowell, NC 28098.

VIDEO SPECIAL EFFECT PLANS



Actual B-W photo of Color Effect

Exciting **COLOR Special Effect** video in Music Videos... works with any video camera or VCR... instructions to build, very to use. Send check or money order for \$19 plus 11% shipping and handling for complete package including schematic, PCB printer, supply & instructions (One Fee add 1.00 sales tax) or send SASE for Free Brochure to

VIDEO EFFECTS
4908 BRACKENHILL ROAD
CLEVELAND OHIO 44131

SUPER-SURVIVAL CATALOGS—Eighty publications—Electronics, Computers, Energy, Weapons, Security, Medical, Financial—\$1. "High Voltage Devices" (\$12), "Electromagnetic Brainbleater" (\$25), "Disk Service Manual" (\$25), "Computer Phreaking" (\$15), "Voice Disguiser" (\$7), "Automatic Teller Machines" (\$15), "Heal Thyself!!" (\$8), "Polygraphs" (\$15), "Consumertronics" (CBS "60 Minutes"), 2011 Crescent, Dept. RE-17, Alamogordo, NM 88310.

6032 infrared tubes (tested and guaranteed). Infrared kits, complete line of engineering and surveillance viewers. **IR SCIENTIFIC, INC.**, Box 110 Carlisle, MA 01741. (617) 667-7110.

CABLE-TV

WE'LL MATCH OR BEAT ANYONE'S ADVERTISED RETAIL OR WHOLESALE PRICES!

BONANZA!

ITEM	SINGLE UNIT PRICE	DEALER 10-UNIT PRICE
RCA 36 CHANNEL CONVERTER (CH. 3 OUTPUT ONLY)	29.95	18.00 ea.
PIONEER WIRELESS CONVERTER (OUR BEST BUY)	88.95	72.00 ea.
LCC-58 WIRELESS CONVERTER	92.95	76.00 ea.
JERROLD 450 WIRELESS CONVERTER (CH. 3 OUTPUT ONLY)	105.95	90.00 ea.
SB ADD-ON UNIT	109.95	58.00 ea.
BRAND NEW — UNIT FOR SCIENTIFIC ATLANTA	Call for specifics	
MINICODE (N-12)	109.95	58.00 ea.
MINICODE (N-12) VARISYNC	119.95	62.00 ea.
MINICODE VARISYNC W/AUTO ON-OFF	179.95	115.00 ea.
M-35 B (CH. 3 OUTPUT ONLY)	139.95	70.00 ea.
M-35 B W/AUTO ON-OFF (CALL FOR AVAILABILITY)	199.95	125.00 ea.
MLD-1200-3 (CALL IF CH. 2 OUTPUT)	109.95	58.00 ea.
INTERFERENCE FILTERS — CH. 3	24.95	14.00 ea.
JERROLD 400 OR 450 REMOTE CONTROLLER	29.95	18.00 ea.
ZENITH SSAVI CABLE READY (DEALER PRICE BASED ON 5 UNITS)	225.00	185.00 ea.
SPECIFY CHANNEL 2 or 3 OUTPUT <i>Other products available — Please Call</i>		

Quantity	Item	Output Channel	Price Each	TOTAL PRICE
California Penal Code #593-0 forbids us from shipping any cable descrambling unit to anyone residing in the state of California.				SUBTOTAL
Prices subject to change without notice				Shipping Add \$3.00 per unit
				COD & Credit Cards — Add 5%
				TOTAL

PLEASE PRINT

Name _____
 Address _____ City _____
 State _____ Zip _____ Phone Number (____) _____
 Cashier's Check Money Order COD Visa Mastercard
 Acct # _____ Exp. Date _____
 Signature _____

FOR OUR RECORDS

DECLARATION OF AUTHORIZED USE — I, the undersigned, do hereby declare under penalty of perjury that all products purchased, now and in the future, will only be used on cable TV systems with proper authorization from local officials or cable company officials in accordance with all applicable federal and state laws.

Dated: _____ Signed: _____

Pacific Cable Company, Inc.

7325½ RESEDA BLVD., DEPT. # R-6 • RESEDA, CA 91335
 (818) 716-5914 • No Collect Calls • (818) 716-5140

IMPORTANT: WHEN CALLING FOR INFORMATION
 Please have the make and model # of the equipment used in your area. Thank You

JUNE 1986

★ QUALITY PARTS ★ DISCOUNT PRICES ★ FAST SHIPPING!

ALL ELECTRONICS CORP.

SEND FOR FREE NEW 1986 CATALOG... 48 PAGES!

EDGE CONNECTORS
ALL ARE 1.56" SPACING

- 22/44 EDGE CONNECTOR
PC style \$7.00 each
10 for \$16.00
- 22/44 EDGE CONNECTOR
 solder lug style \$9.50 each
10 for \$22.00
- 22/56 EDGE CONNECTOR
PC style \$2.50 each
10 for \$22.00
- 36/72 EDGE CONNECTOR
PC style \$3.00 each
- 43/86 EDGE CONNECTOR
PC style \$4.50 each

- TRANSISTORS**
- 2N709 4 for \$1.00
 - 2N2222A 3 for \$1.00
 - 2N2222A 6 for \$1.00
 - 2N2904 3 for \$1.00
 - 2N2904 3 for \$1.00
 - 2N2905 3 for \$1.00
 - MJ2955 \$1.50
 - 2N3055 \$1.00
 - PNM 10Kx0 \$1.00
 - TP 121 75¢
 - TP 123 78¢

- TRANSFORMERS**
- 120 volt primaries
- 5.5 vdc @ 750 ma \$2.00
 - 6 vdc @ 150 ma \$2.00
 - 6.3 volt @ 600 ma \$2.00
 - 12 VOLT @ 200 ma \$2.00
 - 12 VOLT @ 400 ma \$2.00
 - 12 VOLT @ 1 amp \$4.00
 - 12 VOLT @ 2 amp \$4.85
 - 12 VOLT @ 4 amp \$7.00
 - 18 volts @ 1 amp \$3.50
 - 24 VOLT @ 200 ma \$2.00
 - 24 VOLT @ 1 amp \$4.85
 - 24 VOLT @ 2 amp \$6.75
 - 24 VOLT @ 4 amp \$8.85
 - 24 VOLT @ 4 amp \$11.80
 - 24 VOLT @ 150 ma \$2.00

- WALL TRANSFORMERS**
- All plug directly into 120 volt outlet
- 4 VDC @ 70 ma \$2.00
 - 6 VAC @ 500 mA \$3.50
 - 8 VDC @ 750 mA \$4.50
 - 9 VDC @ 500 mA \$5.00
 - 12.8 VDC @ 295 mA \$3.00
 - 15 VDC @ 16 mA amp \$4.50
 - 8.5 VAC @ 1.25 VA \$3.00
 - 24 VAC @ 250 mA \$3.00
 - MULTI-VOLTAGE @ 500 mA \$3.00
 - 3.4V, 6.7V, 9 or 12 VDC \$7.50
- MINI-BOX**
Pomona #2104
\$1.00 EACH
- Heavy duty black phenolic project box with cover and screws 2 1/4" x 1 1/4" x 1 1/2"

- FUSES**
- 3AG (AGC) SIZE
1/2, 2/4, 3/4, 5/8 AMP
GMA SIZE
1, 2, 3, 4, 5 AMP
5 of any ONE amperage 75¢

SOUND AND VIDEO MODULATOR FOR T.I. COMPUTER

TL# UM1381-1. Designed for use with T.I. computers. Can be used with video sources. Built-in A/B switch. Channel 3 or 4 selection switch. Operate on 12 vdc. Hook-up diagram included.

CAT# AVMOD WERE \$10.00 **REDUCED TO \$5.00 EACH**

SPECIALS

1 AMP 50 VOLT DIODES
INAD01 TAPE AND REEL
100 for \$4.50
1000 for \$30.00

SOLDER TAIL I.C. SOCKETS
24 PIN 10 for \$2.50
100 for \$22.00
1000 for \$200.00

SPECIAL PRICE TRANSISTOR

plastic transistor
PN3569 TO 92 N.P.H.

100 for \$8.00
1000 for \$60.00
LARGE QUANTITIES AVAILABLE

48 KEY ASSEMBLY FOR COMPUTER OR HOBBYIST

NEW T.I. KEYBOARDS. Originally used on computers, these keyboards contain 48 S.P. S.T. mechanical switches. Terminates to 15 pin connector. Frames 4" x 9" CAT# KP-48 \$6.50 each
2 for \$11.00

TI SWITCHING POWER SUPPLY

Compact, well-regulated switching power supply designed to power Texas Instruments computer equipment.

INPUT: 14 - 25 vdc @ 1 amp
OUTPUT: +12 vdc @ 350 mA.
- 5 vdc @ 1.2 amp
- 5 vdc @ 200 ma.

SIZE: 4 1/4" x 5 1/4" x 1 1/2" high \$5.00 each

13.8 VDC REGULATED POWER SUPPLY

These are solid state, fully regulated 13.8 vdc power supplies. Both feature 100% solid state construction, fuse protection, and L.E.D. power indicator. U.L. tested.

2 amp constant, 4 amp surge \$18.00 each
3 amp constant, 8 amp surge \$25.00 each

D.C. CONVERTER

Designed to provide a steady 5 vdc @ 240 ma. from a battery supply of 3 to 6.25 volts

2 1/2" x 1 1/2" x 1 1/2"
\$1.50 each

MICRO-CASSETTE MECHANISM

Micro-cassette tape transport for standard MC60 or MC45 micro-cassettes. 3 Vdc operation. Contains: drive motor, belt, head, capstan, pinch wheel and other components. 3 1/2" x 2 1/4" x 5/8"

CAT# MCMC \$3.00 each 10 for \$27.50

COMPUTER GRADE CAPACITORS

- 2,000 mfd. 200 Vdc 1 3/4" x 5" high \$2.00
- 8,400 mfd. 50 Vdc 1 3/8" x 3 3/4" high \$2.50
- 9,700 mfd. 50 Vdc 1 3/8" x 4 1/2" high \$3.00
- 21,000 mfd. 16 Vdc 1 3/4" x 4" high \$2.50
- 50,000 mfd. 40 Vdc 3" x 6 3/4" high \$4.50
- 66,000 mfd. 16 Vdc 3" x 3 3/4" high \$3.00
- 80,000 mfd. 40 Vdc 3" x 6" high \$3.50
- \$6,000 mfd. 16 Vdc 2" x 3 3/4" high \$3.00
- 66,000 mfd. 30 Vdc 2" x 5 1/4" high \$3.50
- 5,500 mfd. 30 Vdc 1 3/8" x 3 1/2" high \$1.00
- 5,500 mfd. 50 Vdc 1 3/8" x 2 1/4" high \$1.00
- 8,100 mfd. 50 Vdc 2" x 4 1/2" high \$1.00
- 18,000 mfd. 10 Vdc 1 3/8" x 2 5/8" high \$1.00
- 44,000 mfd. 10 Vdc 2 1/2" x 3 1/4" high \$1.00
- 190,000 mfd. 10 Vdc 2 1/2" x 6" high \$1.00
- 185,000 mfd. 6 Vdc 2 1/2" x 4 1/2" high \$1.00

RECHARGEABLE NI-CAD BATTERIES

- AAA SIZE 1.25V 500MAH \$1.85
- AA SIZE 1.25V 500MAH \$1.85
- AA with solder tab \$2.00
- C SIZE 1.2V 1200MAH \$3.90
- D SIZE 1.2V 1200MAH \$3.90

UNIVERSAL CHARGER

Will charge 4-AA, C, D, or AAA ni-cads of one 9 volt ni-cad at one time!

\$11.00 per charger

TWIST-LOCK CONNECTOR

Same as Switchcraft #12CL5M 5 conductor in-line plug and chassis mount jack. Twist-lock style.

\$2.50/SET

SLIM LINE COOLING FAN

EB# 5 = 99xM182 low noise fan. Measures 3 1/8" square x 1" deep. 21 cfm. 23 db. 1700 rpm.

SPECIAL PRICE... \$12.50 each

RELAYS

10 AMP SOLID STATE

CONTROL: 3 - 32 vdc
LOAD: 140 wdc 10 amp
SIZE: 2 1/2" x 1 1/4" x 1 1/4"

\$9.50 EACH 10 FOR \$90.00

ULTRA-MINIATURE 5 VDC RELAY

Fujitsu #F8211NED005M20
High sensitivity
COIL: 120 ohms
CONTACTS: 1 amp
Mounts in 14 pin DIP socket

\$1.25 each 10 for \$9.00

MINIATURE 6 VDC RELAY

Aromat #RS0-8V
Super Smart
S.P.D.T. w/ally
3 CO contacts
contacts rated

1 AMP @ 30 vdc. Highly sensitive
TTL direct drive possible. 120 ohm coil.

Operate from 4.3 - 6 vdc.
COIL: 120 ohms \$1.50 each
1 1/2" x 7/8" x 1 1/4" 10 for \$13.80

3 1/2" SPEAKER

9 ohm impedance, Full range speaker
8 oz magnet
4" diagonal mounting corners

\$2.50 each 10 for \$20.00

SPRING LEVER TERMINALS

Two color coded terminals on a sturdy 2 1/2" x 3 1/4" bakelite plate.
Great for speaker enclosures or power supplies

75¢ EACH 10 for \$6.00

13 VDC RELAY

CONTACTS: S.P.N.C.
10 amp @ 120 vdc
Energy coil
open contact

COIL: 13 vdc 650 ohms

SPECIAL PRICE \$1.00 each

4POT RELAY

14 pin DIN style
3 amp contacts
USE D but fully tested - \$1.70 each
Specify coil voltage desired
Either 24 vdc or 120 vdc

LARGE QUANTITIES AVAILABLE

SOCKETS FOR 4POT RELAY 78¢ each

RECHARGEABLE NI-CAD BATTERIES

AAA SIZE 1.25V 500MAH \$1.85
AA SIZE 1.25V 500MAH \$1.85
AA with solder tab \$2.00
C SIZE 1.2V 1200MAH \$3.90
D SIZE 1.2V 1200MAH \$3.90

FLASHER LED

8 volt operation
red jumbo T 1 1/2 size \$1.00 each
NEW GREEN FLASHER
CAT# LED-4G \$1.00

BI-POLAR jumbo T 1 1/2 size 3 for \$1.70

LED HOLDERS

Two piece holder for jumbo LED
10 for \$6.00 100 for \$9.00

CLEAR CLIPLITE LED HOLDER

Mega LED a (ency indicator) Clear
4 for \$1.00

2K 10 TURN MULTITURN POT SPECTROL #MOO 534-7161 \$5.00 EACH

± 12 Vdc or 24Vdc POWER SUPPLY

DELTRON MODEL QD12/18-1.7
Dual plus and minus 12Vdc open frame power supply. Can be used as 24Vdc @ 1.5 amp. INPUT: either 115 Vac or 230 Vac.
Fully regulated computer grade supply
7" x 4 1/2" x 2 1/4"

\$12.50 each 10 for \$110.00

220 Vdc COOLING FAN

DELTRON # MX77A3
Magna XL
220 Vdc
4 1/8" square metal frame fan

CAT# CF-270 \$6.50 ea
10 for \$60.00 100 for \$500.00
QUANTITIES AVAILABLE

SPRING LEVER TERMINALS

Two color coded terminals on a sturdy 2 1/2" x 3 1/4" bakelite plate.
Great for speaker enclosures or power supplies

75¢ EACH 10 for \$6.00

MINIATURE TOGGLE SWITCHES
ALL ARE RATED 8 AMPS @ 125 VAC

S.P.D.T. (on-on)
PC style
non-threaded bushing
75¢ each
10 for \$7.00

S.P.D.T. (on-off-on)
Solder lug terminals
\$1.00 each
10 for \$9.00
100 for \$80.00

S.P.D.T. (on-off-on)
PC style
non-threaded bushing
75¢ each
10 for \$7.00

S.P.D.T. (on-on)
Solder lug terminals
\$2.00 each
10 for \$18.00
100 for \$130.00

O.P.D.T. (on-on)
Solder lug terminals
10 for \$18.00
100 for \$130.00

STANDARD JUNBO DIFFUSED T-1/3/4

- RED 10 for \$1.50
100 for \$13.00
- GREEN 10 for \$2.00
100 for \$17.00
- YELLOW 10 for \$3.00
100 for \$27.00

D.P.S.T. LIGHTED ROCKER SWITCH

115 vdc lighted rocker snap mounts in 1/2" x 1 1/4" hole
Orange lens 16 amp contact
\$1.50

MINI-PUSH BUTTON

S.P.S.T. momentary normally open 1/4" bushing
Red button
35¢ each
10 for \$3.00

SNAP ACTION SWITCH

Cherry elect. #E-21 N.O. or N.C. 0.1A contacts. Suitable for alarm and other low energy circuits.
1 1/4" lever.
45¢ EACH 10 FOR \$4.20

ROTARY ACTION MICRO

OMRON #C-5G3-C41
Clockwise action micro used in coin operated mechanisms and low torque operations.
RATED: 5 amps @ 125 VAC
\$1.25 each 10 for \$11.00
LARGE QUANTITIES AVAILABLE

SOLID STATE BUZZER

Star #SAM8-06L
6 vdc
TTL compatible
\$1.00 each
10 for \$8.00

LINE CORDS

TWO WIRE

- 8' 18/2 SPT-1 flat 3 for \$1.00
- 6' 18/2 SPT-2 flat 2 for \$1.00
- 4' 18/2 SPT-2 flat \$1.25 each

THREE WIRE

- 6' 18/3 flat \$1.50 each
- 6' 18/3 round \$2.00 each

7 CONDUCTOR RIBBON CABLE

Spectra-strip red marker strip
28 ga. stranded wire
\$3.00 per 100 roll

XENON FLASH TUBE

3/4" long x 1/8" dia. Flash tube designed for use in compact camera flash units. Ideal for experiments.
CAT# FLT-1 2 for \$1.00

RADIO-ELECTRONICS

ALL ELECTRONICS CORP.
LOS ANGELES, CA STORE
905 S. Vermont Ave.
213 380-8000

VAN NUYS, CA STORE
6220 Sepulveda Blvd.
818 997-1806

MAIL ORDERS TO:
P.O. BOX 20406
Los Angeles, CA 90006

TWX - 510101613 ALL ELECTRONIC
EASYLENK MBX - 62887748



TOLL FREE ORDERS ONLY
1-800-826-5432
(ORDER ONLY)
(IN CALIFORNIA: 1-800-258-6866)
ALASKA, HAWAII, OR INFORMATION
(213) 380-8000 NO C.O.D.'s

QUANTITIES LIMITED
MINIMUM ORDER \$10.00
USA \$3.00 SHIPPING
FOREIGN ORDERS
INCLUDING SUFFICIENT SHIPPING
CALIF. RES. ADD 6 1/2%

OMRON #C-5G3-C41
Clockwise action micro used in coin operated mechanisms and low torque operations.
RATED: 5 amps @ 125 VAC
\$1.25 each 10 for \$11.00
LARGE QUANTITIES AVAILABLE

COMPUTER DIGEST

VOL. 3 NO. 6

June 1986

A NEW KIND OF MAGAZINE FOR ELECTRONICS PROFESSIONALS

WHEN LIGHTNING STRIKES

How Will It Effect Your Equipment



GERNSBACK

LOCAL AREA NETWORKING

Computers Working Together

THE GENERAL PURPOSE INTERFACE BUS

All You Should Know

CONTENTS

Vol. 3 No. 6

June 1986

6 Local Area Networking

When you have to get a lot of computers handshaking, here's the basics of how and why. **Forrest Stone**

10 When Lightning Strikes

What can it mean to your computer and how can you protect against it? It happened to one of our authors! **Herb Friedman**

12 GPIB

If you don't know about the General Purpose Interface Bus, here's a chance to get caught up. **Marc Stern**

3 Editorial

4 Letters

4 Computer Products

5 Software Review



See Page 6

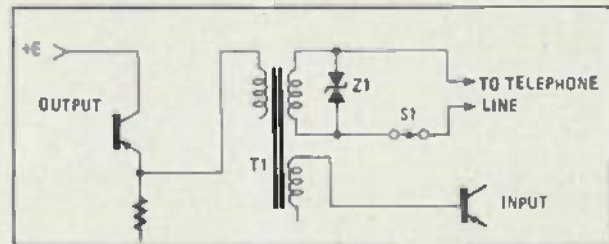

See Page 10

ON THE COVER

Lightning can put on a magnificent display but it has frightening overtones. Just how protective is the protective equipment you've installed? Is your system *really as safe* as you think it is? Our author relates a close call. See Page 10. (Photo courtesy approved lightning protection, Elmont, NY.)

COMING NEXT MONTH

If you can't get your modem talking, you might just find the answer in this fact-filled article, More On Modems. And when you need an interface that will make things work together that weren't designed to, you might get some excellent use out of this Protocol Converter that we show you how to build. There's something new in Touch Screen Technology, called Surface Acoustic Wave, and we'll fill you in on that too. Of course, you'll find our usual mix of Computer Products, Software Review and Letters to the Editors. Don't miss it!

EDITORIAL

"If I give a man a fish...

■He can have dinner. If I teach him *how* to fish, he can eat for the rest of his life."

A friend opened a school to teach computing at a commercial level. He made the courses available (with suitable grants) to the underprivileged, and envisioned hundreds, even thousands of graduates going out and earning salaries well-beyond their ken when they started the course. The students flocked to the school. To them, it represented an opportunity to learn a valuable skill at little or no outlay of cash.

But a strange thing happened. While many began the course, only few completed it! The first part of the course included typing, and this was followed by key punch. It was *only after* the student had mastered typing and key punch skills that he sat down to a computer keyboard. But very few were actually getting to the computer. They were taking the preliminary skills they had learned to market, and were getting jobs as typists or key punch operators. Certainly, the salaries they earned were not as great as a computer operator could command, but they were far in excess of what could have been earned in a factory as an unskilled laborer.

How many young men have dropped out of high school to take jobs as gas station attendants or truck drivers, because the minimal salaries offered sounded like manna to a single youth? How many have been lured into civil service positions with meagre incomes, eyeing the 20 year retirement? And how many of these could have led far-more prosperous lives, making a far-more meaningful contribution to society, had they but continued their educations?

A very-wise employer, early in my career cautioned me that "meagre security has been the downfall of many an otherwise good man." If you're a youngster, reading these words, please think twice, even three times before you bring your education to a halt. Raise your sights. There's no telling what might lay in store for you if you do.

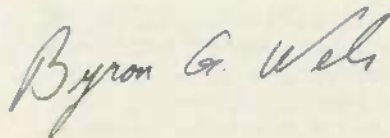

Byron G. Wels
Editor

ComputerDigest is published monthly as an insert in Radio-Electronics magazine by Gernsback Publications, Inc., 500-B Bi-County Blvd., Farmingdale, N.Y. 11735. Second-Class Postage Paid at New York, N.Y. and additional mailing offices. Copyright © 1986 Gernsback Publications, Inc. All rights reserved. Printed in U.S.A.

A stamped self-addressed envelope must accompany all submitted manuscripts and/or artwork or photographs if their return is desired should they be rejected. We disclaim any responsibility for the loss or damage of manuscripts and/or artwork or photographs while in our possession or otherwise.

COMPUTER DIGEST

M. Harvey Gernsback,
editor-in-chief, emeritus

Larry Steckler, EHF, CET:
publisher & editor in chief

Art Kleiman,
editorial director

Byron G. Wels,
editor

Brian C. Fenton,
managing editor

Carl Laron,
associate editor

Robert A. Young,
assistant editor

Ruby M. Yee,
production director

Karen Tucker,
production advertising

Robert A. W. Lowndes,
production associate

Geoffrey S. Weil,
production assistant

Andre Duzant,
technical illustrator

Jacqueline P. Cheeseboro
circulation director

Arline R. Fishman,
advertising director

Computer Digest
Gernsback Publications, Inc.
Executive offices
500-B Bi-County Blvd.,
Farmingdale, NY 11735
516-293-3000
President: Larry Steckler
Vice President: Cathy Steckler

ADVERTISING SALES
516-293-3000

Larry Steckler
Publisher

NATIONAL SALES

Joe Shere
1507 Bonnie Doone Terrace
Corona Del Mar, CA 92625
714-760-8967

LETTERS

Saving Copies

I'm sure we share a common problem. I tear out and save my **ComputerDigest** but have been wondering if you've found a better method than just stacking them? S. T., New York, NY.

Get what is called a "presentation folder" at any office-supply store. This consists of a clear plastic folder with a slide-on plastic backbone. If you cut the plastic folder right along the fold, you'll find that this setup neatly holds a full year's worth of the magazine.

College bound

I'm going to be starting college shortly, with an eye to a career in

book or magazine editing. I'm sorry, but you are on my list of editors to write to for advice. What courses would you recommend that I take?—R. J., Bridgeport, CT.

R. J., you'll have to take the usual English lit and composition courses, as well as journalism courses. But do make it a point to get in some time on computer word processing! This will speed your output, make you more accurate, and it's the wave of the future.

Computer "Heroes"

I've heard people involved deeply with computers described as everything from "nerds" to "eggheads." Considering that they've managed to accomplish so very much in this scientific field,

why aren't they given the recognition they deserve? —S.D., Atlanta, GA.

Next time you hear a computerist being put down, notice who's doing the putting down. It's probably some computer illiterate! Usually, it's just jealousy talking.

More help

My very kind, well-meaning father bought me a Commodore Plus-4 from a TV ad. Can anybody direct me to some software—ANY software for the machine? And is there an expert on the hardware out there that I can get some answers from? Please PLEASE write to Jerry Sadofsky, 4839 Manderson, Omaha, NE 68104.

Hope this helps Jerry.

COMPUTER PRODUCTS

For more details use the free information card inside the back cover



PROOFREADING PROGRAM, *Sensible Grammar*, is designed to check word-processing files for common writing errors. It goes beyond conventional proofreading programs that check the spelling of individual words, and uses its library of over 1000 commonly misused English phrases to identify pompous, informal, cliché, vague, wordy, repetitive, and other faulty phrases. *Sensible Grammar* also catches many punctuation, capitalization, and other typographical errors, such as repeated words. It

shows errors in context, automatically suggests replacement wordings, and lets the user immediately replace problem phrases with correct wording.

Sensible Grammar is fully compatible with AppleMouse and features a Macintosh-style user interface with windows, pull-down menus, scroll bars, and dialog boxes. A complete set of keyboard commands is also supplied for Apple II owners without a mouse. A 128K Apple IIe or IIc with 80-column display is needed.

Sensible Grammar is priced at \$99.95.—**Sensible Software, Inc.**, 210 S. Woodward, Suite 229, Birmingham, MI 48011.

CIRCLE 7 ON FREE INFORMATION CARD.

TRANSPORTABLE PERSONAL COMPUTER, the model A-200, exists in both mini floppy disk and hard-disk versions. It weighs 19 pounds, can be carried easily, and operates on AC. (A carrying bag is optional and makes for even easier portability.)

The unit includes a built-in foldaway, 80-column x 25-line text screen and

graphic liquid crystal display with a resolution of 640 x 200 pixels. By using an RGB monitor interface, a color monitor may be used when color graphics are desired. With a 512 kilobyte RAM (expandable to 640 kilobyte using an optional expansion box and



memory card) and two 5¼" 360-kilobyte disk drives, the user has access to a large memory capacity not usually available with portables.

The model A-200 is IBM PC compatible and also has an IBM-style keyboard layout; it has the capability for many software packages now available. The suggested retail price is \$2,295.00.—**Canon USA,**

CIRCLE 8 ON FREE INFORMATION CARD.

SOFTWARE REVIEW

Is there a "universal software?" No, but this comes close...

■When the going gets tough: When the communications circuit is loaded with garbage: When the data must be exchanged absolutely error-free, or when at least one station must be unattended, the software of choice for PC and MS-DOS computers is often Crosstalk XVI. In fact, Crosstalk is the "standard of reference" to which much software is compared.

With few exceptions, all personal computer communications software can do both ASCII (direct keyboard entry and ASCII files) and protocol exchanges, but unlike much of the communications software, which is primarily intended for ease of operation when exchanging ASCII text with bulletin boards and information services, Crosstalk XVI is oriented towards convenient handling of error-free protocol exchange using an automodem.

Crosstalk's protocol exchange is done in blocks of 256K (or a multiple of 256K) which are checked at the destination for accuracy of reception. If the program senses an error the system will keep retransmitting (within limits) until it's received accurately.

The main power of Crosstalk is that the originating computer automatically controls the host (receiving) computer—there is no need to have anyone in attendance at the host. The originating computer can open and close the receiving computer's buffer, write to disk, read from disk, get a directory listing, and even control several DOS functions such as DIR, DELETE and COPY. In the protocol mode all functions and the data exchange are automatic, with the originating computer automatically controlling the write to disk at the host.

Just about every Crosstalk parameter is indicated on a status screen that can be instantly switched to a blank screen for data display of text or messages. Among the parameters shown are the telephone number of the receiving station, all the communication parameters such as baud rate, mode (originate or answer), the state of the capture buffer (on or off), the filter settings, and the automatic send control settings. The filter setting controls such things as automatic line feed after carriage return, filtering of all control characters, and automatic stripping of a received eight bit, etc.

The lower section of the status screen is either a library of lesser-used commands and functions, or a directory of "command files," which are basically saved status screens for individual computers and information services such as CompuServe, MCI, Dow Jones, etc. Status screens are automatically assigned a key number when saved to disk: Simply entering the indicated number loads the pre-set status screen conditions and automatically dials the telephone if you're using an automodem. (In the initial installation of Crosstalk a menu selects the proper modem commands for all commonly-used automodems, and some that are not so commonly used.)

Changes to the screen status can be made at any time by entering the first two letters of the function into a command line which runs across the bottom of the

screen. For example, to change from full to half duplex the user need type only DU (plex) on the command line. To select a specific key to function as the transmitted BREAK the user simply enters the command BR (eak) and presses the key he wants to use as the Break key. Similarly, the user can force the program into the originate or answer mode through the MO (de) command. A rather extensive help screen can be called up for any function by entering HELP and the first two letters of the function on the command line.

Although Crosstalk XVI is intended to run on 16-bit PC/MS-DOS computers, it can also do protocol exchanges with 8-bit CP/M computers that use the CP/M version of Crosstalk. Even if one computer is 8 bits, when serving as a host (answer mode) Crosstalk provides two levels of protection against unauthorized use or meddling with the disk files. The first is a password of up to 12 characters: If the correct password isn't given on the third try Crosstalk causes the modem to disconnect from the line. (Yes, the password protection can be disabled.) The second level of protection are file attributes. Through the host's status screen the originating station can be permitted to have full access to the system (including DELETE), read only, write data into an existing file ("capture data"), or append data to existing files or create new files.

Macros or commands can be programmed into the computer's function keys in three levels: Ten normal, ten shifted, and ten control. Function key F4 is an answerback which sends a user prepared string when polled by a Control-E from the receiving or host computer: It's the way in which many Telex and electronic mail services automatically determine the user's account number or identification.

A particularly advantageous feature is user programming of both the printer and modem parts on the status screen (so a particular configuration is saved in a command file). Crosstalk is not limited to COM1: for communications. If the printer is already connected to the computer through the COM1: serial port, Crosstalk can use COM2: for the modem, or vice versa. You arrange the printer and modem ports the way you want them.

To make the program "universal" Crosstalk also has the XMODEM protocols. The RXMODEM command tells Crosstalk to receive an XMODEM file transfer, the XXMODEM command tells Crosstalk to send a file using XMODEM protocols.

We have touched on only the major highlights of Crosstalk: Those that insure data integrity, which is what it's really all about. Although Crosstalk can be used with a manually switched modem, and like all other communications programs can be used for conventional ASCII exchange, it is really easiest to use in the automodem and protocol modes.

Crosstalk XVI is intended for PC/MS-DOS computers. For additional information write to Microstuf, 1000 Holcomb Woods Parkway, Roswell, GA 30076. ◀▶

LAN— Local Area Networking

How to get lots of computers handshaking—and why.

Forrest Stone

■Broadband! Baseband! Twisted Pair! Star! It's enough to confuse even the most dedicated computer hobbyist, but, Local Area Networking is the wave of the future for many people and these are some of the terms that a network user will be confronted with.

Local Area Networking has developed a terminology all its own. There are nodes and servers; tokens and CSMA/CD, and much more. What it really boils down to is a system of linking microcomputers into a shared network where each micro has access to the system's resources. (See Fig. 1)

If this system sounds similar to the mainframe or minicomputer worlds with their linked terminals and shared system resources, it should. A microcomputer Local Area Network is a microcosm of a typical mainframe network. But, when you move to Local Area Networking in the microcomputer world you gain an added bonus, you retain the versatility of the microcomputer, while gaining the capability of a much larger system.

Think of your first microcomputer installation. If



FIG. 1—3COM'S ETHERNET is a shared system with each micro sharing system resources.

you've been involved with this hobby long enough then it was probably a small eight-bit system whose storage device was a cassette recorder. The next big advance in this system was the move to a floppy disk and the addition of a printer. At each point, the system gained capability. Eventually, your eight-bit system probably gave way to a 16-bit system, which may even include a 5- or 10-megabyte hard disk, as well as color-graphics capability. Compared to your first system, this is a quantum leap in its capacity and flexibility.

For most single users, this type of system is more than adequate—you can move up to a high-speed, high-powered 32-bit processor, to stay at the cutting edge of technology, but for most single users, this type of processor is overkill—it can easily handle any chore. But, a funny thing has happened in the corporate environment. Users want to have access to the corporate mainframe or minicomputer, while retaining the off-line personal computing power of a microcomputer.

They want to use the data contained in various mainframe databases; or want access to the mass storage capability of the system, or they may simply want to communicate with someone on an electronic mail system.

Whatever the reason, it's at this point that the single-user microcomputer system begins to show its

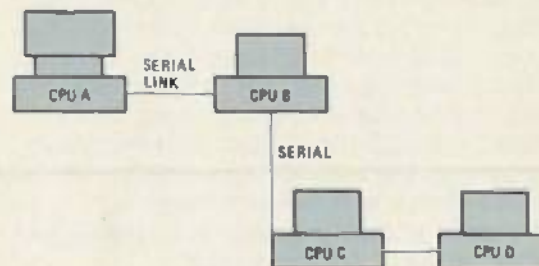

FIG. 2—THE SERIAL NETWORK looks eminently workable, but does have its problems.

inadequacy. Because of its standalone nature, the single-user system is effectively cut off from the rest of the corporate world, unless, of course, a communications modem is attached to a serial port. In that case, the micro can conceivably interact with others in the company. But this is inefficient because of the need for a telephone line on both ends. Effectively, this microcomputer can only interact with a remote, online database or with only one other corporate microcomputer.

Search for solutions

When this point is reached in any corporation, microcomputer users begin to look for alternatives. The simplest and most obvious solution is a serial communications network, or linking the serial communications ports of all the microcomputers involved. While it appears feasible, this type of network has inherent problems. (See Fig. 2)

First, when you daisychain microcomputers into a serial network, the systems on the farthest end of the loop will find performance degraded, unless line amplifiers are included in the network. Further, the speed limit on this type of network is effectively constrained to about 9600 bits per second, providing of course, that the environment is clear of interference which can glitch data as it moves through. This puts an effective limit of between 4800 and 9600 baud on the network and while this may seem fast enough, when you move massive amounts of data from one point to another, you'll find this speed level limiting.

Second, the software needed to make this type of system work—a terminal or communications program—is still essentially for single use. Although some programs will allow you to set up microcomputers as mini-bulletin boards so that others can log on and interact with the information stored on disk, it is still essentially one user-one computer, whether it's remote or not. For example, if you turn your personal computer into a mini-bulletin board so others on the serial network can use the data you have stored on disk—provided the software will let you do this without a modem. And someone wants to log onto your computer. When he does, others are locked out until the job is finished because of the single-use nature of the software.

Finally, the very nature of a serial system imposes real threats to data integrity and transmission within the system because of a factor known as contention or the ability to remain in control of the network long enough to transmit, receive or manipulate data before you lose the system to another microcomputer's data and signal.

A serial system is truly contention-based. It's every user for himself and every data bit for itself. It's like a rush-hour intersection with a broken traffic light and no policeman to control traffic. Only those cars whose drivers push through will make it, timid drivers don't. And, when two aggressive drivers meet, there's the inevitable crackup. To bring this back to the computer realm, put microcomputers in place of the cars and change the intersection to the serial transmission system and you can see what's happening. Data from

the strongest microcomputers, usually at the center of the system, controls the system and weaker, peripheral systems must wait and wait.

And when two strong computers try to capture the system, their data usually crashes into one another and its integrity is gone.

Enter the LAN

The obvious solution to this situation, then, is the Local Area Network. It allows users to share system resources and data, while, at the same time, allows users to retain the versatility and power of their personal computers.

In concept, the Local Area Network (LAN) is simple. It is a reliable version of the serial network we've already discussed. However, you'd think from all the jargon that's tossed around relating to LANs, that it was a mystic rite. It isn't, but it does take some explanation to demystify the jargon.

As you wade through the LAN jungle, it's easy to become confused by the seemingly endless variety of systems on the market. A wide variety of LANs does exist, but, they can be identified by their transmission technology, cabling or configuration.

For example, there is one type of LAN which uses PBX (Private Branch EXchange) technology to link all its members. The PBX has traditionally been used to link phones throughout a building and then onto the Common carrier network.

Manufacturers of PBX-based systems, traditionally such companies as AT&T, Northern Telecom and ROLM, see the existing base of telephone wiring—twisted pair—installed in major buildings and hope to take advantage of it by using that wiring to link personal computers into local area networks. It is true that this presents a cost-effective way of handling cabling, but it does impose speed penalties. Because the data

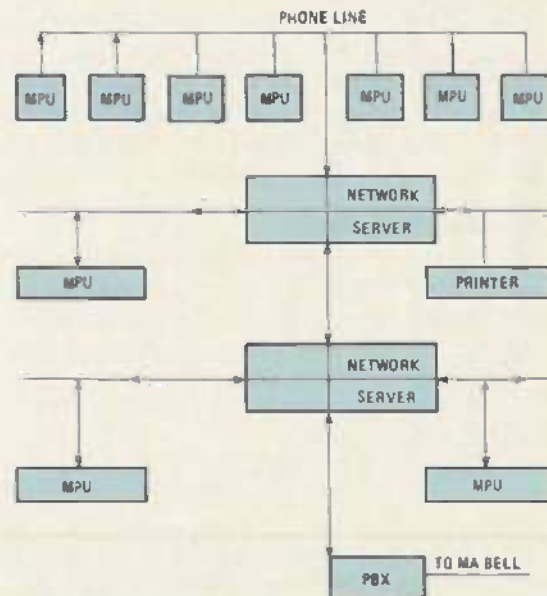

FIG. 3—SIMPLIFIED VIEW of a building's phone wiring and PBX LAN. System uses existing wiring and PBX loop to link CPU's and microcomputers. It has a high limit of 19.2 kilobaud.

transfer rate of PBX technology is only on the order of 9600- to 19,200-baud, it may not be high enough to handle massive amounts of speedy throughput. Data transfer rates on the order of 56K baud are needed to make this type of system effective and even that is a minimal figure in a fairly active network. (See Fig. 3)

When you move away from PBX-based LANs, you enter a realm which requires the installation of separate cabling systems to handle data transmission (even our mythical serial system requires a separate cable). The advantage of this type of LAN is that you can implement broadband or baseband technology.

In a broadbanded system, several discrete channels of information are transmitted on a single cable. It is a complex technology. A simpler solution is baseband technology. In a baseband system, there is only one channel per cable and you can effectively increase the data transmission rate beyond that of either PBX or broadband systems.

Typically, transmission rates in a broadbanded system—Interactive Systems/3M and Sytek offer them—are relatively slow on a per-channel basis at 19.2K- to 56K-baud, although they are much higher than on PBX-based systems. The real savings comes in cabling an installation. Several channels can be superimposed on a cable and because the several data transmissions can occur simultaneously, the amount of cable used in a system (most used coaxial cable) can be kept to a minimum.

Against this savings, there are increased costs for the installation in the form of extra equipment and costly maintenance. A broadband system requires the installation of an RF modem at each network node. These devices translate the analog signals used on the cable into digital signals so that they can be used by the microcomputers and other peripherals on the network. Further, this type of system is more costly and time-consuming to maintain.

Like broadband technology, baseband handles much higher transfer rates than PBX-based systems—some as high as 1 megabit have been implemented. It can also integrate other concurrent applications, including voice and video data transfer. The leaders in this market include 3Com and Ungermann-Bass.

LAN protocols needed

Although LAN technology looks formidable, it isn't. It's just a way of hooking microcomputers into a shared-resource network. Like our allusion to the intersection, each network needs a "traffic cop" to work efficiently. Otherwise, data would continuously crash into other data within the network and little would be accomplished.

The leading protocols are carrier-sense multiple-access with collision detection (CSMA/CD) and token-passing.

With CSMA/CD all microcomputers on the network have equal access to the network and its resources. The software which drives this type of system continuously monitors data on the cable and keeps things in order. For example, if microcomputer A has accessed the system and is moving data to a file

server—an intelligent storage device such as a hard disk or a microcomputer equipped with a hard disk that is serving in data storage or transfer role—and microcomputer B wants to access the same server. In a CSMA/CD system, the software will determine which data has priority—actually which one accessed the system first—and will allow that data through. Data from microcomputer B will be held until the network is free for access. Typically, this is all transparent to the user.

In a token-passing scheme—advocated by Digital Equipment and Xerox in their Ethernet—the software polls each microcomputer node in turn asking if it must access the network. If the microcomputer is busy, it returns no answer and the system moves along to the next microcomputer. Polling is handled through the token, which is actually a coded sequence to which each microcomputer responds.

Like passing a baton in a foot race, each microcomputer that is accessing the system takes hold of the token when it arrives and this tells the network to accept its data. When the data is put on the system, the token is freed to pass to the next microcomputer. In this way, data retains its integrity and there is order within the system. It's much like a major highway control system with timed traffic lights. It allows orderly entry from side streets (microcomputers), while minimally disrupting overall traffic flow. And, it prevents collisions.

Network configurations

As you deal with baseband LANs, you'll find three predominant configurations, the star, ring, and bus.

In the star configuration, the network is laid out similarly to the spokes of a wheel. Each microcomputer is at the end of a piece of cable that is, in turn, connected through a central switch. Data is sent to the switch where it waits until the network is free to accept it. Likewise, data which is being sent to each terminal waits at the switch until the terminal is ready to accept it. (See Fig. 4)

The ring network is a closed loop system, with each terminal along the perimeter of the system. Many of the ring systems on the market use the token protocol. (See Fig. 5)

The last configuration is the bus. In this type of installation the network is laid out as a backbone with each microcomputer at the end of a "rib." Information travels down the "ribs" and onto the main bus where it waits until it can be moved down the network. (See Fig. 6)

In all of this, there is a common theme, communication. Like our simple serial system, the LAN is simply a communications system which links and allows all the microcomputers connected to the network to have access to system resources. The typical configuration can be for as few as three machines or for as many as several hundred, depending on the needs of the organization. In a large system, a mainframe or minicomputer is usually used to drive the network. The network can be configured to use the storage capacity of the mainframe or mini,

although local storage can also be made available to various network nodes through file servers. Nodes are system devices such as microcomputers, servers, printers or modems. Any device capable of interfacing with a microcomputer can serve as a node.

File servers are microcomputers themselves. For

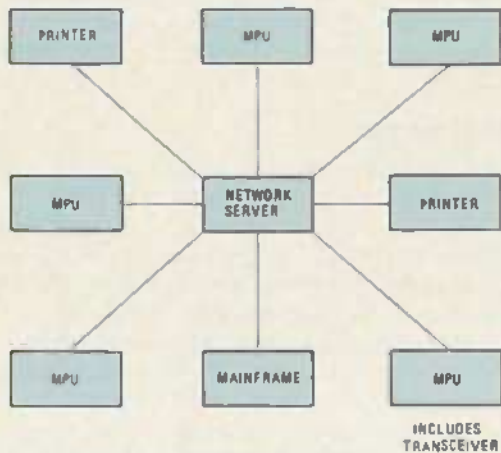

FIG. 4—SIMPLIFIED STAR configuration shows components arranged as the spokes of a wheel.

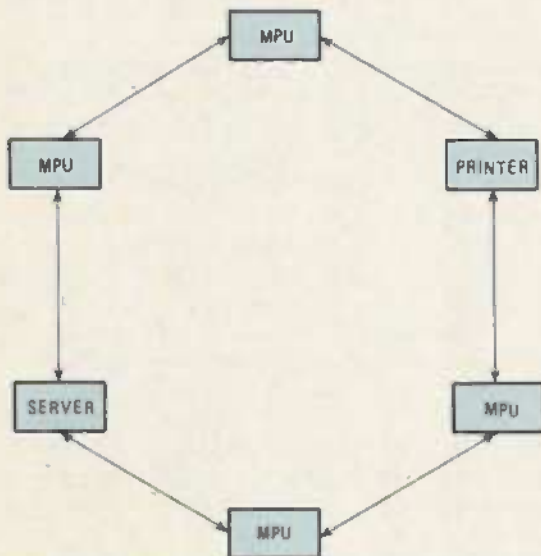

FIG. 5—THE RING CONFIGURATION connects all components in a circular fashion.

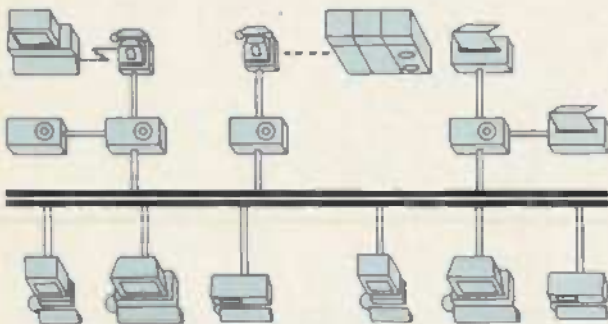

FIG. 6—THE BACKBONE LAN has "ribs" connected to a "spine." Components are connected to the ends of the "ribs" as shown.

example, a 3Com server uses an 80186 central processor with an 82582 Ethernet coprocessor. Included with this configuration is 512K of RAM. The processor, coprocessor and RAM are all included on one board. The server also includes a 36-megabyte hard disk with a 30 ms average access time. In its own right, it is a powerful computer system. In other systems, hard disks can have as much as 60 megabytes of storage. Many systems have three or more servers in their configuration, each of which interfaces not only with the microcomputers on the network, but also mainframes, if they are used to drive the system. To insure data backup and reliability, most systems also include tape backup systems.

LANs are more than just linking microcomputers. A LAN allows users to share system data and storage capacity, and printers, plotters and more. In fact, it makes sense in a network where a laser printer is used because each microcomputer user has access to its capability and it also helps justify the laser printer's cost.

Software's the key

As you would expect, installing a LAN involves more than just linking microcomputers. In a typical 3Com system, each microcomputer has a network transceiver board installed on its motherboard. This transceiver is the link to the network and allows the microcomputer to interact with it. It is the mailbox to which data is sent and received. The cable is attached to it and it is the device which the network software talks to.

When a transceiver is ready to send data to the network, a special software code is generated. It is a query code and an announcement. The query segment polls the central system node to see if the LAN will accept data from the microcomputer. This "Here I Am" code packet is held until the network is ready to accept the data. When the system is ready, it answers the query code with an acknowledgement and the data is transferred to the system.

Each transceiver has its own special address code. This code enables the system to send data to a particular device or microcomputer and, likewise, it enables one microcomputer to send data to another via the network.

Cable types

When you talk about LANs, the last thing that is usually mentioned is the type of cabling. In general, LANs use either coaxial or twisted pair technology. PBX-based systems usually use twisted pair—phone cabling—technology, while broadband or baseband systems use coaxial cable. This isn't to say that a baseband system can't use two-wire, twisted pair technology because it can. On the whole, coaxial, triaxial, too is used for most applications.

As you can see, the LAN will make a great contribution in areas where it makes sense to share resources and if you're involved in the switch to a LAN, there's only one thing to remember: its basis is network communications; the jargon used is secondary to its mission. ◀▶

WHEN LIGHTNING STRIKES...

Lightning strikes can be a problem for your computer.

Herb Friedman

■ Before the age of electronics, the fear of lightning was not so much its immense electrical energy but the fire caused by the "hit" or "strike." Lightning protection meant some means of directing lightning to where it wanted to go—to ground. This was done by installing grounded metal rods—lightning rods—on top of houses, barns, windmills, whatever. The purpose was twofold. It grounded the energy and it conducted the energy around the structure.

With the electronic age, we inherited the worry of the electronic field produced by the strike. Very high fields are built up in the ground during an electrical storm. The ground field can track under a charged cloud and travel for miles before anything occurs. When the charge between the ground and the cloud

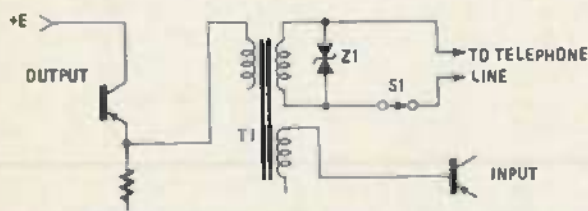

FIG. 1—THE BASIC ELEMENTS of a direct-connect modem's interface to the telephone line. Z1 is a surge suppressor that squashes transient voltages appearing across the line to approximately 50 volts. S1, which disconnects the modem from the line, is usually SPST.

becomes sufficient the energies attract and we get the lightning strike. At the moment of strike there is an enormous discharge of ground energy, which creates a rapid expansion and collapse of a local electric field. Any collapsing or expanding field induces both current and voltage in wires. Although lightning might strike a tree in front of a house, the energy field produced during the strike can induce high frequency transient voltages in antenna lead-ins, power lines and telephone lines located 50 to 100 feet or more from the actual hit.

Lightning arrestors

While a lightning arrestor can protect antenna lead-in wires from direct hits and devices such as Zener diodes and MOV's (Metal Oxide Varistors) can protect conventional electronic equipment against powerline surges, microprocessors and other electronic devices are often "blown" by transients induced by the lightning strike which are not of sufficient power to trigger a lightning arrestor, but which are strong enough to blow discrete components. There are many instances on record where the voltage surge induced in electric, telephone and antenna lead-in wires by a local lightning hit has been known to zip through the wiring and blow a TV tuner or the microprocessor of a personal computer, even if the computer is turned off or disconnected from the power line.

Even if disconnected? Yes! Solid state devices—particularly microprocessors—are sensitive to external high-frequency voltage surges because the surge can enter the equipment through any external wire connection, not just the power line. While low and medium frequency AC can be stopped by an open switch, an RF choke or a small reactance, high-frequency energy, such as that produced by a lightning strike, can leap across open switches, couple from one wire to another through otherwise insignificant capacitive coupling, even pass between insulated transformer windings. While we have made great strides in squashing power line transient surges with devices such as the MOV and gas-discharge tube, technology has not caught up with the problems caused by lightning surges in personal computer equipment.

For example, electrical storms are unusual in my locality, we get one or two every five years or so. Between the previous one and this year's electrical storm, several computers and modems have taken up

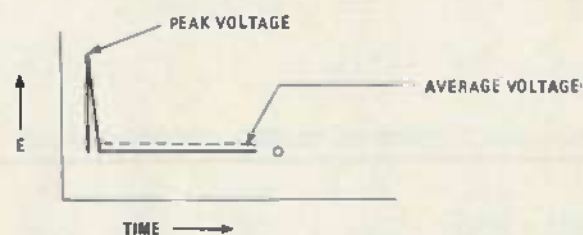

FIG. 2—THE LOCAL GROUND-DISCHARGE FIELD energy is almost an instantaneous rise and decay. This produces high-frequency energy through the upper VHF frequencies. In practical terms, it is high-voltage RFI.

residence in my home. In our most-recent electrical storm, lightning struck outside and disintegrated ten feet of curb. That was the only damage I thought, because my two computers were switched off, as were their modems. However, when I attempted to access an on-line information service, I discovered that both modems were blown, as was one computer's RS-232 driver (the one used for the modem). Coincidentally, the same storm passed through the area 20 miles away where my office is located, and lightning had struck the grounded radio/TV tower on the building.

Since my regular modems were inoperative, I borrowed the office modem which had been switched off during the storm, only to find that it too, was "blown."

Interesting situation

Three modems of different design and manufacture had been blown during an electrical storm. All had some form of voltage surge protection, all had been switched off and one didn't even have a connection to the power line because it is powered directly from the phone line. A fourth modem, built into an IBM-PC which was connected on-line because it serves as a "host" for a voice message center, wasn't damaged at all!

What to do

As near as we can determine, the three "blown" modems were damaged because of the way they were switched to the telephone line. Figure 1 is a simplified diagram of a direct-connect modem interface. Transformer T1 is the coupling transformer (repeat coil), Z1 is the telephone line overvoltage or surge-protection device, and S1 is a SPST switch that connects the modem to the telephone line. Normally, a voltage surge on the line is squashed by transient suppressor Z1, which might be a MOV, Zener diode, or gas-discharge tube. Usually, Z1 limits the surge to about 50 volts.

As shown in Figure 2, a voltage developed in the telephone line by a lightning strike in the general area

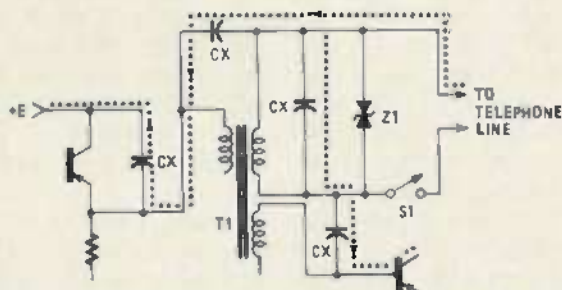

FIG. 3—CAPACITOR "Cx" IS THE NORMAL circuit capacity between transformer windings, solid-state device elements and component interconnecting wires. Cx is usually so small that it doesn't exist at audio frequencies but can represent a low impedance or "dead short" at the high frequencies of a lightning strike. When S1 is opened the lightning strike energy can follow the dotted path into the modem and eventually the high voltage bus where it is distributed throughout the modem, even to the modem's special driver.

will be a steep pulse. Although the average voltage—meaning the peak voltage averaged over a period of time—might be relatively low and safe, the peak value might be several hundred volts, and it is predominantly high frequency—extending well into the upper VHF range. High frequencies don't need a direct connection to pass from one wire to another. What is otherwise a minute capacity between wires and circuits, can appear to be "dead short" to high frequencies.

Imagine that the ground discharge of a lightning strike induces the transient waveform shown in Figure 2 on the telephone line connected to the modem circuit shown in Figure 3. Although S1 is open, disconnecting the modem from the telephone line, one wire is still connected to the line itself because almost all modems switch only one side of the telephone connection. We now have a high-frequency voltage surge on the telephone line which is looking for a path to ground. As shown by the dotted line in Figure 3, it finds the path to ground through the components in what we believe to be a disconnected modem. Notice that the energy represented by the dotted line flows through the capacity between T1's windings. The capacity might be very small, but it is there. To normal speech frequencies the capacity represents essentially an infinite impedance, but to the high frequency component of a lightning-caused transient surge the small capacity represents a low impedance, or even a "dead short," so the spike produced by the voltage surge passes through T1's secondary (telephone side) to the primary (modem side) to the modem's voltage supply bus. Now we have a high-voltage transient on what is usually a five- to nine-volt power bus. The result? ZAP!!! A fistful of blown IC's. If the surge is sufficiently high, it can ride through a blown IC in the modem and into the RS-232 driver, ZAPPING another handful of parts.

You might ask why Z1, the modem's internal transient suppressor(s) didn't stop the surge. Refer back to Figures 1 and 3. Z1 is connected across the telephone line: It is supposed to clamp surges appearing across the line, between both wires. But when switch S1 is opened to disconnect the modem from the telephone line, the transient suppressor has no effect on anything in the circuit. Z1 provides protection only when S1 is closed and the modem is connected to the line. This is probably why the direct-connect modem, connected on-line during the storm, wasn't damaged. Essentially, the risk of damage during an electric storm is increased when the modem is switched off the line.

My "cure"

Most likely, modems should be manufactured with a double pole output switch so that both sides of the telephone line can be disconnected from the modem. Until such time as the manufacturers get around to changing their designs, I have installed a DPST knife switch on each telephone line to make certain the modems are really disconnected from the line. The inconvenience of "throwing the switch" is a lot less costly than the charges to repair or replace three modems and an RS-232 port. ◀▶

GPIB

The General-Purpose Interface Bus...

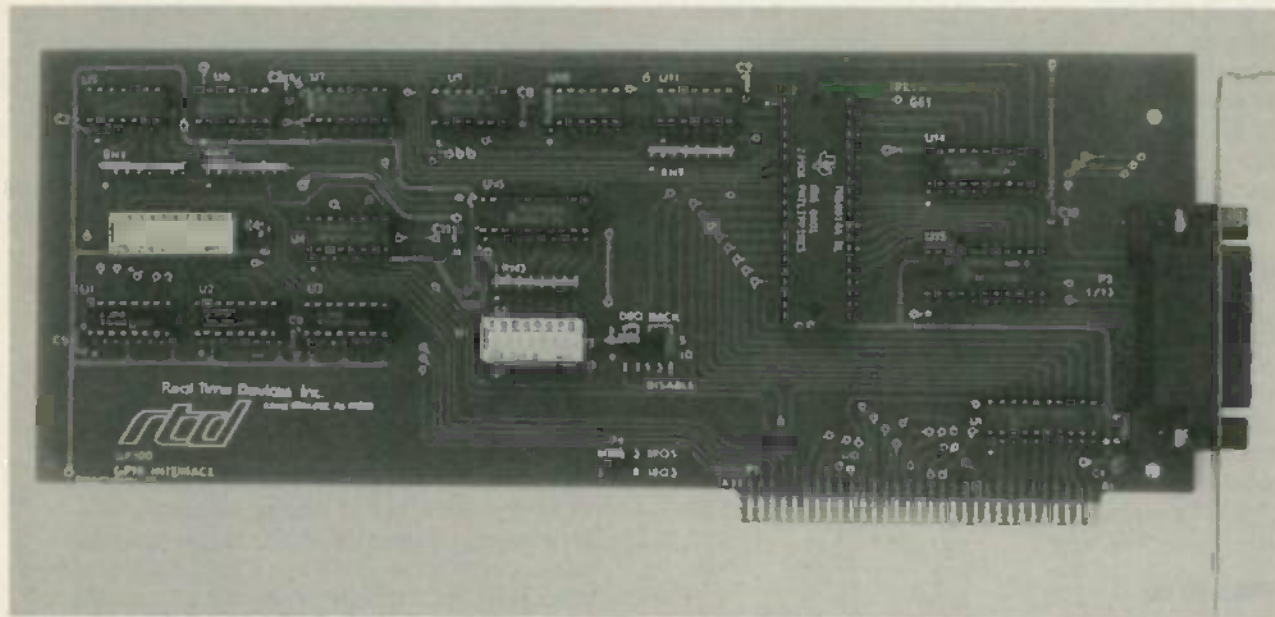

REAL TIME DEVICES GPIB Interface is shown here. It functions with all IBM PC and compatibles to expand the value of your computer.

Marc Stern

■ If you look at your test bench, chances are you'll see the General Purpose Interface Bus (GPIB) connector. Also known as the HP-IB (Hewlett-Packard Interface Bus), it's been around for some years and has become the standard for data acquisition.

GPIB was developed for tying one manufacturer's equipment together. But, because of the widespread use of that equipment in the scientific, test and measurement and repair arenas, it became standard. By the mid-1970s, it was formalized into the IEEE-488 standard. And even a computer giant such as IBM must use it rather than imposing its own.

Look at any modern test or measurement equipment that has a computer interface. You'll see it adheres to the IEEE-488 standard as to the size and shape of the connector; the construction, and the pinout.

Why not give your PC more function by having it interface with and act as part of your test equipment setup? It's easy to do, and, in fact, there are add-on boards on the market which will turn your PC into a machine capable of using the GPIB interface. One of the newer boards is from Real Time Devices of State College, PA. Other boards are available from the major add-on board manufacturers.

GPIB Basics

Before we go any further, there are several basics to be established.

First, GPIB is a 24-line communications bus that is made up of three primary groupings, an eight-line data bus, a three-line data byte transfer control or handshaking bus and a five-line general interface management bus. The remaining eight lines are for signal ground and provide electronic shielding to prevent bus signals from interfering with one another.

Second, there are four types of devices which can be linked to the GPIB, a controller, "talker," "listener" and "listener/talker." As you'd expect, the controller is the device which controls the network, while a "listener" is a receive device. A "talker" is a transmit device and a "listener/talker" is a device which can go both ways. It can transmit and receive on the bus. Prime examples include the PC as controller; digital voltmeter or frequency counter as "talker;" printer as "listener;" and modem as "talker/listener."

Third, it's a programmable. As implemented on the GP-100, the GPIB can be programmed to more than 50 functions in not only BASIC, but also Fortran, Pascal and Forth. And, as implemented, it becomes the major input-output (I/O) device on the PC in a test and measurement setting. It can also serve as a listener/talker if the network is controlled by still another computer.

Finally, the GPIB relies on direct memory access to the PC. In this way, the board and PC can communicate at 476 Kbytes per second and the systems can exchange up to a megabyte of data with a single

function call.

GPIB is a powerful tool, especially where huge amounts of data must be moved around a system quickly.

It can also be used in a more general atmosphere and can link up to 15 printers, plotters, modems or other devices into a small network.

Though the GPIB may seem a panacea, it isn't because, like the RS-232 "standard," IEEE-488 has been used differently by different manufacturers. So, it can be confusing to see a device advertised as adhering to the 488 standard, only to find out the device's lines are used differently. True, the connector may be the same and the lines may also be called the same, but, if a manufacturer implements them in its own way, then simply calling it standard won't make it so. Instead, you'll have to patiently debug the interface until it coincides with others.

Fortunately, most manufacturers adhere to IEEE-488 as does the GP-100, so you should have little trouble.

High-speed data link

One of the items which made GPIB successful from the outset was its speed. The bus can potentially handle up to 1 megabyte of data per second, although data transfer rates of 1 to 10K are more common. With this type of throughput, it's possible to have real-time data input to a micro, mini or mainframe system, which is crucial in scientific, test and measurement of manufacturing applications. With this type of speed measurements can give real-time indications of what is happening and a system can quickly adjust.

For the technician, the GPIB's speed is attractive. With the PC interfaced with test equipment, you can have indications on the screen of what's happening in a part of a circuit and, as you change inputs, you can see how the rest of the circuit is affected.

Another reason for the success of this circuit is its configurability. Since 15 devices can be quickly attached and configured to work with the GPIB, a system's configuration can be adjusted to constantly-changing needs. If you need constant voltmeter and current readings from two points in a circuit and must also plot them. You can quickly add the needed devices to the circuit and you can record the results for future use. Plugging the new devices into the appropriate GPIB connectors should achieve this, provided, of course, the network adheres strictly to GPIB.

Since this bus is programmable, it is possible to transfer data directly from one device to another.

Data's everywhere

The data which moves through the bus appears at all points simultaneously and there's a need to keep things in order. Imagine devices which have no need of the data accessing and using it along with the device for which it was intended. It's a waste of system resources.

Each device has an address and only when the controller sends a message to that address does the device react. Until then, it listens for its address to be accessed. For example, if the printer is at address 8

and you send output to the printer, the controller—IBM-PC in this case—puts an address 8 on the bus and the printer comes to life. Devices that aren't at this address ignore the information, even though it appears at their connectors.

There are two types of addresses, talk and listen. A device doesn't know what its next role will be or if it will take part in a function until it is addressed on the GPIB. The talk and listen addresses take care of that. For example, if a device sees its talk address then it knows it has to send data along the bus. A device which sees its listen address accessed knows it will have to accept data.

In action, the first piece of information a device receives is its listen address. This makes the device aware that it will be receiving information from the bus. Once it is listening, the controller can communicate with it, but, only after the computer-controller puts its talk address on the bus. In this way, the device knows which peripheral it will be communicating with.

Sometimes the device acting as the listener must indicate something to the controller, such as a paper jam or dead phone line and GPIB allows it. Of the 24 lines on the bus, only 8 are used for data, while the rest are reserved for grounding or special use. One of these is the Service Request line. It can be used by any device to indicate a problem has developed or a request must be made.

All the devices attached to the GPIB use the same SRQ line and since they do the controller must have a way of finding out which devices need attention.

There are three ways of handling this, the serial poll, in which each device is polled in turn by the controller; the parallel poll, in which all devices are polled concurrently, or the selective parallel poll, in which each data line is polled and once the line is found with the device that needs service, the controller polls all devices on that line serially.

Bus lines

The GPIB has 24 conductors, whose functions can be thought of in three groups. (See Fig. 1)

The first eight lines of the interface are the data bus. These lines are used to transfer data from one point or device to another. Since there are eight lines associated with the data bus, it can transmit one digital word or byte at a time (eight bits).

The handshaking or data byte transfer control lines enable various devices to handshake with one another. Without this function, there would be no need for the data bus, since the devices couldn't "talk." A talker device must know when a listener is ready to accept the next data byte. The Not Ready For Data line supplies this information to the talker.

The Data Valid line tells the listener whether the information it is receiving is important or just noise. That line tells the receiver that the data is good.

The other part of the GPIB's handshaking is performed by the Not Data Accepted line which tells the talker whether the listener has accepted the data.

Ultimate control, though, is provided by the five general interface management lines: Interface Clear (IFC)

R-E Computer Admart

Rates: Ads are 2 1/4" x 2 1/8". One insertion \$825. Six insertions \$800 each. Twelve insertions \$775. each. Closing date same as regular rate card. Send order with remittance to Computer Admart, Radio Electronics Magazine, 500-B Bi-County Blvd., Farmingdale, NY 11735. Direct telephone inquiries to Arline Fishman, area code-516-293-3000. Only 100% Computer ads are accepted for this Admart.

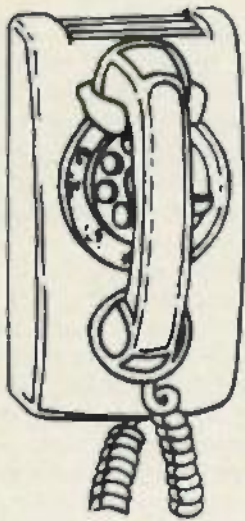

CALL NOW AND RESERVE YOUR SPACE

- 6 x rate \$800.00 per each insertion.
- Reaches 229,044 readers.
- Fast reader service cycle.
- Short lead time for the placement of ads.

Call 516-293-3000 to reserve space. Ask for Arline Fishman. Limited number of pages available. Mail materials to: Computer Admart, RADIO-ELECTRONICS, 500-B Bi-County Blvd., Farmingdale, NY 11735.

NEW TECHNICAL SOFTWARE

IBM-PC AND 100% COMPATIBLES
LDW-COST • POWERFUL • ELEGANTLY
SIMPLE

INTRODUCTORY PRICE — \$54.53 EACH

- 101-B EE1 - Solve most-used circuit equations fast. 128K COLOR OR MONO
- 106-B EE2 - 20 AC circuit programs. HF effects, etc. 128k. GRAPHICS
- 103-B PLOT - Plot equations. Vectors, Rectilinear, Polar, Simultaneous, Equation solver. BASICA, GRAPHICS
- 104-B MATH 1 - Parabolic dish design, Triangles, Straight lines, Factors, Progressions, more. 128k. GRAPHICS
- 105-B UNITS 1 - A Masterwork of units conversions, Systems of units, Constants, etc. 64K. COLOR OR MONO

PROWESS, INC., 203 Lakeridge Village,
Suite 102, Dallas, Tx. 75238
(214)-349-4718

CIRCLE 192 ON FREE INFORMATION CARD

A Z-80 WORKSHOP MANUAL

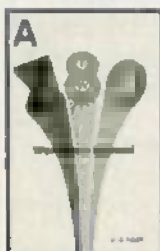

Starting with a review of computer principles, this book describes typical machine-code instructions followed by a detailed description of the Z-80 instruction set. Assembly language programming is also discussed with examples. Z-80 hex machine-code and assembler instructions are given in tabular form, along with in-out connections for the Z-80 and its associated devices.... Order your copy from Electronic Technology Today Inc., PO Box 240, Massapequa Park, NY 11762. Price is \$6.95 plus \$1.00 for shipping.

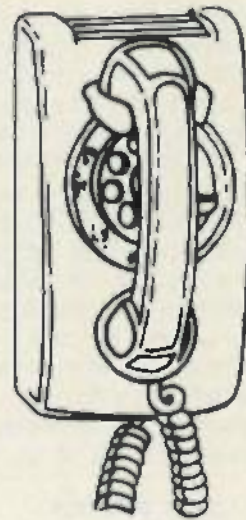

CALL NOW AND RESERVE YOUR SPACE

- 6 x rate \$800.00 per each insertion.
- Reaches 229,044 readers.
- Fast reader service cycle.
- Short lead time for the placement of ads.

Call 516-293-3000 to reserve space. Ask for Arline Fishman. Limited number of pages available. Mail materials to: Computer Admart, RADIO-ELECTRONICS, 500-B Bi-County Blvd., Farmingdale, NY 11735.

is a reset; Attention (ATN) is a master bus command from the controller; SRQ is the special request line; Remote enable (REN) enables the controller to issue special commands to devices on the GPIB, finally End or Identify (EOI) is used as an end of message signal.

GPIB operates with a low-true logic convention. Because of the construction of this bus and the fact that everything is tied in in series, everything stays low until the last device in the series has accepted data. This means handshaking continues throughout the data transfer and waits for the slowest listener on the bus.

IBM interface

The GP-100 board and others use direct memory access, which speeds the data transfer process to and from the PC. For example, using input-output and handshaking routines and programming them results in a data transfer rate that will be below 100Kbytes per second. That is because the program must observe the handshaking protocol of the device with which it is

communicating. Direct memory access, however, allows the GPIB board to place commands directly in the PC's memory and thus communications can be speeded to 476 Kbytes per second. To implement this, you must know where the transfer will occur; the number of bytes, and whether the data will be input our output.

Boards such as the GP-100 can also issue interrupts to your PC so events that happen along the GPIB can be trapped and monitored as they are detected. The PC services the board and bus as soon as the interrupt is implemented.

GPIB has become a standard which began out of a company's desire to tie its equipment together with some order and certainty. It allows the technician to tie his PC in with his test equipment for a computerized testing system. In the future it will become a necessity as things get more complicated. By then, only a computer will be able to keep up. So, it's wise to start early and use GPIB to its fullest. ◀▶

FREE power radio, modern design. send \$4 for detailed plans. **MERIDIAN SYSTEMS**, Box 116, Elliot, ME 03903.

MOBILE telephone, paging system using your 2-way radio, plans \$9.95 each, w/PCB 19.95. Answer phone using your recorder, plans 6.95 w/PCB 12.95. Parts available. **CURRENT DEVELOPMENT CORP.**, Box 384, Westmoreland, NY 13490.

STEREO simulator. Plans, parts and PCB only \$10. **DAVIS ELECTRONICS**, 2871 S.124th, West Allis, WI 53227.

UNCYPHERS American and Canadian satellite or cable, latest technology available. Plans & boards. Kits or complete. Send \$5.00 for catalog. Refundable on order to **PILGRIM VIDEO PRODUCTS**, Box 203, Oak Street, Pembroke, MA 02359.

CB MODIFICATIONS

Increase channels, range, privacy! We specialize in frequency expanders, speech processors, FM converters, PLL & slider wicks, how-to books, plans, kits. Expert mail-in repairs & conversions. 16-page catalog \$2. Our 11th year!

CBC INTERNATIONAL, P.O. BOX 315007, PHOENIX, AZ 85046

FREE catalog 99-cent kits-audio, video, TV, computer parts. **ALLKIT**, 434 W. 4th St., West Islip, NY 11795.

CRYSTAL radio sets, plans, parts, kits. Catalog \$1.00. **MIDCO**, 660 North Dixie Highway, Hollywood, FL 33020.

DESCRAMBLER plans. New design decodes gated sync suppressed signals-newest pilotless method. Circuit boards, most parts from Radio Shack. Detailed theory, drawings, schematics, instructions \$14.95 plus \$2.00 shipping. **DIRIJO CORP.**, Box 212, Lowell, NC 28098.

CABLE and **SUBSCRIPTION TV** secret manual. Build your own descramblers, converters. Instructions, schematics for sinewave, inband/outband gated sync, S-SAVI-(H)BO, Showtime, Cinemax, UHF, etc.) Send \$8.95 to **CABLETRONICS**, Box 30502R, Bethesda, MD 20814.

BUILD this five digit panel meter and square wave generator including an ohms, capacitance and frequency meter. Detailed instructions \$2.50 refundable plus 50 cents. **BAGNALL ELECTRONICS**, 179 May, Fairfield, CT 06430.

REEL-TO-REEL TAPES

AMPEX professional series open reel tape, 1800- or 2400-feet on 7-inch reels. Used once. Case of 40, \$45.00. 10 1/2 X 3600 feet and cassettes available. MasterCard Visa. **VALTECH ELECTRONICS**, Box 6-RE, Richboro, PA 18954. (215) 322-4866

INVENTORS

INVENTORS! Can you profit from your idea? Call **AMERICAN INVENTORS CORPORATION** for free information. Over a decade of service. 1-800-338-5656. In Massachusetts call (413) 568-3753.

PRINTED CIRCUIT BOARDS

CIRCUIT BOARDS, guaranteed lowest quotes. Single and double sided boards. Prototypes through large production quantities. Mail specifications for quotes. **HOBBYISTS**: Print your own circuit board. Kits of all sizes, low prices. Basic Kit, \$4.00 materials for two 3" x 4" boards (included), or SASE for catalog to **T.O.R.C.C.C. ELECTRONICS**, Box 47148, Chicago, IL 60647. (312) 342-9171.

PCB 15 cents sq-in. Free drilling. Quantity discounts. Professional work **International Enterprise**, 6452 Hazelcreek, Simivalley, CA 93063.

LEARN TV/VCR REPAIR

Now you can train at home in spare time for a money-making career as a TV/VCR Repair Specialist. No previous experience necessary. No need to quit your job or school. Everything is explained in easy-to-understand language with plenty of drawings, diagrams and photos. We show you how to troubleshoot and repair video-cassette recorders and TV sets, how to handle house calls and shop repairs for almost any make of television or VCR. Tools are included with your course so you can get "hands-on" practice as you follow your lessons step by step. Send for free facts about the exciting opportunities in TV/VCR Repair and find out how you can start making money in this great career. **MAIL COUPON TODAY!**

SCHOOL OF TV/VCR REPAIR, Dept DE056
Scranton, Pennsylvania 18515

Please send me full information and color brochure on how I can learn TV/VCR Repair at home in my spare time. I understand there is no obligation and no salesman will visit me.

Name _____ Age _____
Address _____
City/State/Zip _____
Phone (____) _____

ELECTRONIC COMPONENTS

RESISTORS, any value/quantity (Minimum 20/value). 1/4 watt \$.01, 1/2 watt \$.02+ \$1.25 shipping. Quantity discounts, 1,000+. Send wattage(s), value(s) Quantity(s) and remittance. **CAPACITORS** - 50V Ceramic Disk, all values \$1.00 minimum order \$1.00 + \$1.25 shipping. **T.O.R.C.C.C. ELECTRONICS**, Box 47148, Chicago, IL 60647, (312) 342-9171.

EPROM PROGRAMMING

HOBBYISTS: Pretested EPROMs sold with your programming installed. Program listing provided. Fast Service. Write or call: **ROMULUS MICRO-CONTROL**, Box 8669, Rockville, MD 20856; (301) 540-8863.

HIGH VOLTAGE TRIPLERS/MULTIPLIERS

REPLACEMENT FOR

ECG®/GE®/SK®

500A/GE527 & SK3304	8.75	6.95
523/GE528 & SK3308	8.85	7.20
526A/SK3306	8.85	7.20
528/SK3906	10.70	8.70
529/GE529 & SK3307	9.99 3 MIN	7.95 100 MIN.

OUTPUT TRANSISTORS

165/SK3115 & GE58	2.25	1.95	1.75
238/GE57 & SK3710	2.25	1.95	1.75
283/SK3467	2.75	2.35	1.80
25D1341P	2.25	1.95	1.75
25C1172B	2.25 5 MIN	1.95 50 MIN.	1.55 100 MIN.

AUDIO POWER

TYPE	10 min	50 min	100 min	TYPE	10 min	50 min	100 min	TYPE	10 min	50 min	100 min
192/SK3895	30.25	21		196/SK3054	49.44	39		201/SK3440	49.44	39	
193/SK3274	30.25	21		197/SK3083	59.54	49		202/SK3445	49.44	39	

RECTIFIER DIODES

125	1000V/2.5A	70¢	500	60¢	1000	50¢
156	1000V/5A	18¢	160	16¢	130	13¢
506	DAMPER/HI-VOLT-FAST RECOVERY	29¢	240	24¢	190	19¢

\$\$ ADDITIONAL SAVINGS \$\$

TYPE	10 min	50 min	100 min	TYPE	10 min	50 min	100 min
102A	35	32	29	171	49	44	38
123A	18	16	14	184	38	33	28
125AP	15	11	09	185	38	33	28
128	38	35	29	198	60	54	49
129	38	35	29	199	18	15	12
130	59	55	49	234	19	16	13
150	16	13	11	375	44	42	39
162	2.25	1.85	1.49	712	.75	.69	.60
163A	2.35	1.90	1.55				

FOR A COMPLETE LIST CALL OR WRITE—C.O.D. Orders Welcome (Min. Order \$25)

DIGITRON ELECTRONICS

110 HILLSIDE AVENUE, SPRINGFIELD, NEW JERSEY 07081

Toll Free 1-800-526-4928 In NJ 201-378-0016 Telex 138441

PRICES SUBJECT TO CHANGE WITHOUT NOTICE. OFFER GOOD WHILE SUPPLY LASTS.

ECG IS Trade Mark of Philips ECG, Digatron Etc. not associated with PHILIPS ECG.

CIRCLE 57 ON FREE INFORMATION CARD

THE NEW 65/9028 VT ANSI VIDEO TERMINAL BOARD!

* FROM LINGER ENTERPRISES *

A second generation, low cost, high performance, mini sized, single board for making your own RS232 Video Terminal. Use as a computer console or with a MODEM for hook up to any of the telephone-line computer services.

FEATURES:

- Uses the new SMC 9028 Video Controller Chip coupled with a 6502A CPU.
- RS-232 at 16 Baud Rates from 50 to 19,200
- On board printer port
- 24 X 80 format (50/60 Hz).
- For 15,750 Hz (Horiz.) monitors.
- 3 Terminal Modes: H-19, ADM3A, and ANSI X 3.64-1979
- Wide and thin-line graphics.
- White characters on black background or reversed.
- Character Attributes: De-Inten. Inverse or Underline.
- Low Power: 5VDC @ .7A ± 12VDC @ 20MA.
- Mini size: 6.5 X 5 inches.
- Composite or split video.
- 5 X 8 Dot Matrix characters (U/L case).
- Answer back capability.
- Battery backed up status memory.
- For ASCII parallel keyboard.

MICRO SIZE!



\$99.95
(Full Kit)

SOURCE DISKETTE:
PC/XT FORMAT
5 1/4 IN. \$15

ADD \$40 FOR A&T

Digital Research Computers

(OF TEXAS)

P.O. BOX 381450 • DUNCANVILLE TX 75138 • (214) 225-2309

Call or write for a free catalog on Z-80 or 6809 Single Board Computers, SS-50 Boards, and other S-100 products.

TERMS: Add \$3.00 postage. We pay balance. Orders under \$15 add 75¢ handling. No C.O.D. Wa accept Visa and MasterCard. Texas Res. add S.17%. Tx., Foreign orders (except Canada) add 20% P & H. Orders over \$50 add 85¢ for insurance.

ALL SALES SUBJECT TO THE TERMS OF OUR 90 DAY LIMITED WARRANTY. FREE COPY UPON REQUEST.

JUNE 1986

85

Saratoga Electronics



ORDER TOLL FREE

800-621-0854
ext.245

DYNAMIC RAMS

4164 - 150NS \$1.25
41256 - 150NS \$3.25

I.C.'s

M58725 \$1.49
9114E1C \$.90
74S374 \$.39
74S280 \$.39
8237A-5 \$3.50

EPROMS

2716 - 450NS \$2.95
2732A - 450NS \$2.25
2764 - 450NS \$3.00
2764 - 250NS \$3.75
27256 - 300NS \$6.75

PC/AT COMPATIBLE SYSTEM BOARD

\$895

* 1 Megabyte Installed

DRIVES

MIT 4853 QUAD/DS 96 TPI 1/2HT. \$69.95
TM848-2 8" DS/DD 1/2HT. \$99.95
SEAGATE 20MB 1/2HT. \$375.00
QUANTUM 40MB FULL HT. \$795.00
HARD DISK CONTROLLER (OMT1 5510) \$139.00

PC/XT COMPATIBLE SYSTEM BOARD

* 256/640 KB w/o Bios & Rom

\$160

Ask About Our PC/XT System Kit

\$895

\$25 MINIMUM ORDER PRICES SUBJECT TO CHANGE

12380 SARATOGA - SUNNYVALE ROAD
SARATOGA, CA 95070
(408) 446 - 4949



FOR SALE

BUGGED? Wreapped? Find out fast. Countermeasures equipment catalog \$1. **CAPRI ELECTRONICS**, route 1R, Canon, GA 30520.

WANTED: Western Electric, RCA, McIntosh, Marantz, Levinson, Tannoy, Dynaco, Altec, JBL. Tubes, speakers, amplifiers. (713) 728-4343. **MAURY**, 11122, Atwell, Houston, TX 77096.

TUBES, new, unused. SASE for list. **FALA ELECTRONICS**, Box 1376-2, Milwaukee, WI 53201

LINEAR PARTS, TUBES TRANSISTORS — MRF 454 \$16, MRF455 \$12, MRF477 \$11, MRF492 \$16. Catalog **RFFC**, Box 700, San Marcos, CA 92069, (619) 744-0728.

RESTRICTED technical information: Electronic surveillance, schematics, locksmithing, covert sciences, hacking, etc. **Huge selection. Free brochure:** **MENTOR-Z**, 135-53 No. Blvd., Flushing, NY 11354.

OLDTIME radio programs on high quality tapes. Comedy! Adventure! Music! Free catalog **Carl F. Froelich**, Heritage Farm, New Freedom, PA 17349.

TV tunable notch filters. Free brochure. **D.K. VIDEO**, Box 4400, Margate, FL 33063. (305) 752-9202.

TEST equipment, reconditioned. For sale. \$1.25 for catalog. **WALTER'S**, 2697 Nickel, San Pablo, CA 94806 (415) 724-0587.

35-70% savings-bargain catalog for 39 cents stamp. **APEX ELECTRONICS MOD**, 8909 San Fernando, Sun Valley, CA 91352.

LASERS and nightvision surplus components. Free catalog. **M.J. NEAL COMPANY**, 6672 Mallard Ct., Orient, OH 43146.



WRITE FOR McGEE'S SPEAKER & ELECTRONICS CATALOG

1001 BARGAINS IN SPEAKERS
toll free 1-800-346-2433 for ordering only.
1901 MCGEE STREET KANSAS CITY, MO. 64108

TUBES, \$2.49. TV, Audio, Special. 2000 types. SASE brings lists. **ADMF**, 6690 7 Mile, S. Lyon, MI 48178.

IS It True... Jeeps for \$44 through the government? Call for facts! 1-312-742-1142 Ext. 4673.

TUBES "Oldies," latest. Parts, components, schematics. SASE for list. **STEINMETZ**, 7519 Maplewood Ave., RE. Hammond, IN 46324.

CONTINUITY tester/logic probe. New, unique, patented one-prod tester from Europe. Tests most electric and electronic components \$24.95. Battery incl. Distributors wanted. **ROLEK ENT.** P.O. Box 22186, Barrie, Ontario, L4M 5R3, Canada.

CABLE TV/satellite equipment. Huge selection... lowest prices. Catalog \$1.00. **BayCom**, Box 82276, Tampa, FL 33682-2276.

ELECTRONICS, exclusives, surplus and more. Send \$1.00 (refundable) for two discount catalogs! Add another \$1.00 and get 20 Diodes! **JELKINS**, 271 Shirley Street, Boston, MA 02152.

THE BEST PLACE TO BUY, SELL or TRADE NEW and USED EQUIPMENT
NUTS & VOLTS MAGAZINE
Box 1111E • PLACENTIA, CA 92670
(714) 632-7721
Join Thousands of Readers Nationwide Every Month
ONE YEAR U.S. SUBSCRIPTIONS
\$10.00 - 3rd Class • \$15.00 - 1st Class
\$35.00 - Lifetime - 3rd Class

NUTS & VOLTS
RARE GEAR
COMPUTER
SOFTWARE
SCANNERS • OFFICE
TEST EQUIPMENT
MICROWAVE
SATELLITE
ALSO: FISHING
NEW PRODUCTS
COMPONENTS • 8776
ARTICLE BUY
PUBLICATIONS
PLANS • SERVICES

COMMODORE 64 owners, extend the life of your computer with my reset switch. Just plugs in. \$14.95 plans \$5.00. **HARVEY BARON**, Box 196, Bethpage, NY 11714.

TUBES, name brands, new, 80% off list. **KIRBY**, 298 West Carmel Drive, Carmel, IN 46032.



Quality Microwave TV Antennas

Multichannel 1.9 to 2.7 GHz
40dB Gain True Parabolic 20 Inch Dish
Complete System \$84.95 (Shipping Incl.)
Dealerships, Qty Pricing, Replacement Parts

PHINIS-TECH ELECTRONICS

P.O. Box 34772 • Phoenix, AZ 85067
18021 847-7700 \$3.00 Credit all phone orders!
MasterCard • Visa • CDS

TV-SER. Hawaiian Islands Gross \$750,000. Price \$150,000 W/Ph. **GKW ELECTRONICS**, Box 1268 Lahaina, Maui-Ht. 1-808-661-8120.

SUBSCRIPTION TELEVISION DESCRAMBLERS Oak built, surplus pull outs, are sinewave downconverters/descramblers. Units are untested and without AC power cords. Send \$19.95 in money order or cashiers check to: **PAMER ELECTRIC SURPLUS** 12970, Branford St., Suite "M," Arleta CA 91331.

FREE Catalog: Discounted video, telephones, telephone accessories, and computer accessories. **TOOLS FOR COMPUTERS**, POB 727, New Rochelle, NY 10802.

ELECTRONIC discount Catalog, Jumbo 300 pages, major name brands send \$2.00 **HENRY'S**, 100 North 4th Street, Newport, PA 17074-1105.

BATTERIES NiCad, sealed lead acid and more from national brands such as Panasonic, Eagle-Pitcher and others. Write or call for listing **DC POWER INC.**, 1213 Old Colony Rd., Wallingford, CT 06492 (203) 237-2292.

EQUIPMENT for manufacturing printed circuit boards includes Excellon N/C drill, laminator, Chem-cut etcher, exposure unit, many many extras. First \$20K cashiers check and tractor trailer takes all! Call (216) 947-2030.

CATALOG: cable converter and descrambler kits and assembled units. N12 minicode \$98, Jernold 400 \$99, more, Sync restoration unit assemblies in one half hour complete \$79, built \$120. Satellite descrambler kit \$119, built \$190. Surplus components, hobby kits, send \$1, **MINUTE KITS**, Box 531, Bronx, NY 10461.

CIRCUIT boards your artwork single or double side boards small or large production. Save \$\$ **S.A.L. CORP.**, P.O. Box 2893, Fontana, CA 92335.

TRADE three tons electronic test eqpt, commercial, military, schematics for stamps, guns **RED NOR-DSTROM**, 15 Arlavia, Duluth, MN 55811.

TUBES 90% of new, name brands, send stamped self-addressed envelope. **GRAY** 4415 Indianapolis, East Chicago, IN 46312

A SINGER'S DREAM!

REMOVES VOCALS FROM RECORDS!
Now You can sing with the world's best bands! The Thompson Vocal Eliminator can remove most or virtually all of a lead vocal from a standard stereo record and leave the background!
Write or call for a free brochure and demo record.
LT Sound, Dept. R-1, P.O. Box 338, Stone Mountain, GA 30086 (404) 493-1258

CB tune-up manual volume II. Specific adjustments and modifications for peaking all popular CB's. Covers over 1300 radios \$19.95. Visa, Mastercard to: **THOMAS PUBLISHING**, 127 Westwood, Pars, IL 61944.

SCIENTIFIC Atlanta stand alone descrambler priced under \$100. Details \$2. **DIGITEK**, Box 195, Levittown, PA 19059.

TI-94A Software/Hardware bargains. Hard to find items. Huge selection. Fast service. Free catalog **OYNA**, Box 690, Hicksville, NY 11801.

CABLE-TV converters and descramblers. Low prices, quality merchandise, we ship C.O.D. Send \$2.00 for catalog. **CABLETRONICS UNLIMITED**, P.O. Box 266, South Weymouth, MA 02190. (617) 871-6500.

ANTIQUE RADIOS

continued from page 81

Always complete alignment (and any other service!) before setting up the tuning buttons. If you only need to set the buttons, often that can be done without removing the chassis. Instructions for button-setting are often—but unfortunately not always—found on the back cover or inside the cabinet.

The Grunow and the Belmont are very similar in regard to servicing. Alignment must be done with the chassis removed, but the automatic-tuning adjustments can be done in-cabinet. However, the components used in each model differ greatly. For example, the tuning-capacitor plates in each gang of the Grunow are all the same size, so there is an extra pad in series with the oscillator coil to lower capacitance for the oscillator stage. The plates in different gangs of the Belmont, on the other hand, vary according to the needs of the different stages they are connected to.

Before attempting to align an antique radio, check the plates of the tuning capacitor for shorts. A scratching noise heard while rotating the tuning shaft is a good indication of shorted plates. The plates may be bent, or dust, coins, paper clips, etc., may be causing the short. You may be able to use a putty knife to straighten out bent plates.

Dust can be removed with a brush or a vacuum cleaner. If possible, the entire capacitor should be removed and washed.

Your restoration also includes the dial pointer. You should make it line up with the correct frequency. An automatic tuner makes a poor appearance if the pointer doesn't match up with the selected station.

Another problem with pushbutton sets is the pushbuttons themselves. The caps are often missing from them, and I have yet to find a suitable substitute. I'd like to hear your ideas.

That about wraps it up for this month; next time we'll discuss advances in early radio circuits. R-E

NEW 50dB Signal Rejection Filter NEW

For elimination of objectionable or troublesome TV signals

MODEL 26 - Tunable from channels 2 through 6 (\$4.95) (50-54 dB)
MODEL 1422 - Tunable from channels 16A through 22U (\$20.00) (50-54 dB)

For one unit send \$3.00 (retail) plus \$1.00 shipping and handling. Minimum order \$10.00.

GIANT electronic parts grab bag: \$5 Postpaid. All New Parts. Resistors, IC's, caps, transistors, coils, zeners, etc. Prime quality components! Big assortment. Money back guarantee! GE Ni-Cad Sticks: 7.2VDC—1.2 AH. New! \$6. Motorola full wave bridge. MDA920A7. Mini size. 1.5 Amps 600 PIV. Special: 2/\$1 or 10/\$4 postpaid. Write for new catalog. **ODD BALL ELECTRONICS**, P.O. Box 879, Duncanville, TX 75138.

SELL blank video cassettes. Super high grade Olympia VHS T-120. Fully guaranteed. Only \$3.49 your cost. Add \$5.00 shipping and handling for any quantity. **STRANDBERG**, 1001 S. Elm Street, Greensboro, NC 27406. Telephone (919) 274-3775. Check, M.O., VISA or MasterCard account number & expiration date.

WORLD'S best channel 3 notch filter. \$39.95. (Dealer inquiries invited.) **CROSLLEY (A)**, Box 840, Champlain, NY 12919.

CABLE TV converters—All major brands. Wireless remotes with volume, wired remotes. Cable and Video accessories. Cabimaster distributor. Lowest prices. Ship C.O.D. Catalogs \$3.00. **SOME ASSOCIATES**, 256 Broadway, Suite 201, Troy, NY 12180. (518) 274-0608.

MAIL order money makers, 25 page book only \$4.00. **JAMES CADD**, 2402 Springdale Road, Waukesha, WI 53186.

DESCRAMBLER plans for Jerrald. Theory, schematic, parts list, waveforms. For speedy delivery send \$10.00 cash or money order. **BAY STATE ELECTRONICS**, P.O. Box 63, Accord, MA 02018.

BUY BONDS

FREE ADAPTER (Limited offer) with **AS-SORTMENT #103**—consisting of TOKO Coils 144LY-120K, 520 HN-300023, BKAN-K555AXX (2); PCB; Transistors 2N3904 (2), BFG85 (Sub); IC'S 7812, 74123, MC1330A1P, Diodes 1N914, 1N5231B. Only \$25.00. 10% Discount for 5 or more Shipping \$3.00/order MC/Visa/COD. Toll Free 1-800-821-5226 Ext. 426 (orders). **Jim Rhodes, Inc.** 1025 Ransome Lane, Kingsport, TN 37660.

MASTERCARD AND VISA are now accepted for payment of your advertising. Simply complete the form on the first page of the Market Center and we will bill.

CABLE TV

SB3 Descrambler parts to construct project in Feb/84 Radio Electronics. \$49.95 (Dealer inquiries invited). **CROSLLEY**, box 840, Champlain, NY 12919.

DEALERS wanted: Channel 2, 3, and 4 notch filters. Money back guarantee. Send \$15.00 for sample and quantity price list. Specify channel(s). **GARY KURTZ**, Box 291394, Davie, FL 33329.

THIS IS AN EXPANDED-TYPE AD WITH A TINT SCREEN. See how it jumps out on the page. To order your ad in this format calculate the cost at \$3.75 per word for the expanded-type and add 25% for the tint background.

AMAZING DEVICES

PERSONAL DEFENSE AND PROPERTY PROTECTION UTILIZE SPACE AGE TECHNOLOGY. CAUTION THESE DEVICES CAN BE HAZARDOUS AND MAY SOON BE ILLEGAL.

PHASORS

- POCKET PAIN FIELD GENERATOR — IPG50**
Assembled \$64.50
IPG5 Plans \$8.00 IPG5K Kit/Plans \$44.50
- PHASOR PAIN FIELD CROWD CONTROLLER — PPF10**
Assembled \$250.00
PPF1 Plans \$15.00 PPF1K Kit/Plans \$175.00
- BLASTER** - Provides a Plasma discharge capable of puncturing 1/2" cart. Produces a 100,000 WATT PULSE
BLS10 ASSEMBLED \$69.50
BLS1 PLANS \$10.00 BLS1K KIT/PLANS \$69.50
- PLASMA STUN GUN** - Very intimidating and effective 5 to 10 feet 100,000 VOLTS
ITM10 ASSEMBLED \$99.50
ITM1 PLANS \$10.00 ITM1K KIT/PLANS \$69.50

LASERS

- RUBY LASER RAY GUN** — Intense visible red beam burns and welds hardest of metals. **MAY BE HAZARDOUS.**
- RUBJAIL Parts Available for Completing Device** \$20.00
- CARBON DIOXIDE BURNING, CUTTING LASER** — Produces a continuous beam of high energy. **MAY BE HAZARDOUS.**
- LCS All Parts Available for Completing Device** \$20.00
- VISIBLE LASER LIGHT GUN** — produces intense red beam for sighting, spotting, etc. Hand held complete.
LQUS Plans \$10.00 (Kit & Assembled Units Available)
- IR PULSED LASER RIFLE** — Produces 15-30 watt infrared pulses at 200-2000 per sec.
LRG3 All Parts & Diodes Available \$10.00
- BEGINNERS LOW POWER VISIBLE LASER** — Choice of red, yellow, green — provides an excellent source of monochromatic light.
LHC2 Plans \$5.00 LHC2K Kit \$34.50

SECURITY

- SNOOPER PHONE** — Allows user to call his premises and listen in without phone ever ringing.
SNP20 Assembled \$80.50
- SNP2** Plans \$8.00 SNP2K Plans/Kit \$59.50
- LONG RANGE WIRELESS MIKE** — Miniature device clearly transmits well over one mile. Super sensitive, powerful.
MFT1 Plans \$7.00 MFT1K Plans/Kit \$49.50
- WIRELESS TELEPHONE TRANSMITTER** — Transmits both sides of phone conversation over one mile, shuts off automatically.
VWPM5 Plans \$8.00 VWPM5K Plans/Kit \$39.50
- PWMS—LONG RANGE SUPER EAR WITH WIRELESS ATTACHMENT**
PWMS Plans \$10.00 PWMSK Kit \$139.50
PWMS0 Assembled and Tested \$169.50

Our phone is open for orders anytime. Technicians are available 9-11 a.m., Mon-Thurs for those needing assistance or information. Send \$1.00 for catalog of hundreds more similar devices. Send check, cash, M.O., Visa, MC, COD for: **INFORMATION UNLIMITED**
DEPT RB, P.O. Box 716, Amherst, N.H. 03031 Tel 603-873-4730

CIRCLE 72 ON FREE INFORMATION CARD

DO IT YOURSELF TV REPAIR

NEW... REPAIR ANY TV... EASY Anyone can do it. Write, **RESEARCH**, R13 Box 601BR Colville, WA 99114.

THIS IS AN ALL BOLDFACE AD. Boldface words cost 50¢ per word additional. If you want your entire ad in boldface, add 20% to the regular cost of your ad.

EDUCATION & INSTRUCTIONS

F.C.C. Commercial General Radiotelephone License. Electronics Home Study Fast, inexpensive! "Free" details: **Command**, D-176, Box 2223, San Francisco 94126

UNSCRAMBLE satellite signals the easy way. Parts available from Radio-Shack. Send \$19.95 for plans & catalog. Board & Plans \$39.95, kits from \$99.95. **VIOIO RESEARCH**, P.O. Box 2, Kingsport, TN 37660

FREE EVALUATION and ADVISORY SERVICE

For professional electronic technicians by prestigious non-profit organization. Earn University Degree, Bachelors or Masters! Through Home Study! Credit given for previous schooling and professional experience. Upgrade your earning power. Free Details!
CONTINENTAL EDUCATION ASSOCIATES
P.O. Box 1197 - Champlain, NY 12919-1197

ATTENTION ELECTRONIC TECHNICIANS

Highly Effective Home Study BSEE Degree Program for Experienced Electronic Technicians. Our New Advanced Placement Program grants Credit for previous Scheduling & Professional Experience. Advance rapidly! Our 40th year.
FREE DESCRIPTIVE LITERATURE
Cook's Institute of Electronics Engineering
P.O. Box 20345, JACKSON, MS 39209

Now you can have Quality, Service and Economy with

DICK SMITH KITS!

**Featured
in this
issue!**

Playmaster® 200W Mosfet Stereo Amp

Features: CMOS Analog Switching for "soft-touch" controls • Built-in "de-thump" to protect your speakers • LED indicators • Toroidal transformers for lower hum & better efficiency • High-quality HiQHM Mosfet power device • Solder-masked silk-screened PCB • Heavy duty heatinks • All pots mounted on PCB for ease of construction • Built-in overdrive Protection • Step-by-step instruction manual • Satisfaction guaranteed.

Electronics Australia Magazine's Design

You've seen how easy it is to build - now hear the results yourself!

This is the one YOU've been waiting for! With 100W RMS per channel, the all-new Playmaster Series 200 integrated amplifier is almost certainly the best build-it-yourself design available. Feature for feature, dollar for dollar, it more than stacks up against the "big names" in hi-fi (the ones with big price tags to match). And it has features many "biggies" lack — like electronic input switching. The Playmaster 200 has circuitry to handle almost every imaginable input: moving magnet, moving coil, CD player, hi-fi VCR, cassette tuner, and more!

Despite its unbelievable level of performance, the Playmaster 200 is much simpler to construct than previous kits. The masterful design has eliminated 99% of assembly problems (and, just in case, the kit includes our exclusive "Sorry, Dick, it doesn't work" repair service coupon). If you think construction is beyond your level of achievement, you can return the kit within 7 days for a full refund.

A Price-
Performance
Breakthrough

\$299

Cat K-3516

SPECIFICATIONS

- 100W RMS per channel into 8 ohms
- Frequency Response: 8Hz-20KHz (-0.3dB)
20Hz-65KHz (-1dB)
- HUM: -100dB below full output
- Unconditional stability into any load
- RIAA equalization within 3dB
- Distortion > 0.01% (typical) 0.003% 20Hz-20KHz
- Sensitivity MM 2mV (80dB S/N) Line 300mV (90dB)
MC 200uV (75dB) CD 2V (94dB)

TELETEXT DECODER KIT

Featured in
April & May
Radio Electronics



Get more from
your television—
GET TELETEXT!

\$199
ONLY
Cat K-6315

Teletext is information & graphics transmitted as digital data in the VBI (Vertical Blanking Interval) between video frames. You can get the latest weather, scores, stock prices & more at the touch of a button! All you need is a decoder, and ours is not only a superb performer, it's priced to put the competition to shame! Easy to build & requiring very little adjustment, it features: • Pre-adjusted/pre-assembled decoder module • Attractive case with screened front & rear panels • TV, Teletext, & TV/Teletext modes • Newsflash • No user fees • 21 button wired/remotes.

Includes "Sorry, Dick It Doesn't Work" Coupon

If, after assembly, your kit fails to perform, send it back with the fixed service fee, and we'll get it going!

Infra-Red Remote Control Kit

Go wireless! This sleek remote is designed just for K-6315. Requires only a handful of parts—easy to build. At this price, it's not an option, it's a necessity!

\$34.95

Cat K-3425

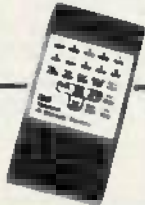

100W Amp Module Kit

The 480 Amplifier is the ultimate in simplicity! It's based on the proven 422 power amp design (without the power transistor wiring hassles) and includes PCB heatsink bracket & on-board fuse protection. Ideal for home or professional use! 100 watts RMS • 100dB signal/noise @ 5kHz

Requires power supply & transformer (see below)

\$19.95

Cat K-3442

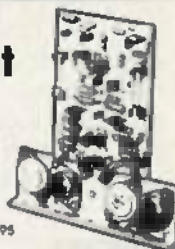

Cat M-0144 Matching transformer \$19.95

Cat K-3436 Matching power supply \$24.95

Compare with
Construction
Article in
this issue!

POWER SUPPLY KIT

Fully variable voltage & current—
Build It yourself and SAVE!

Designed around the LM 317 (a reliable regulator with great features), this supply offers full protection and meters both voltage & current output. Look at these specs:

- Output voltage: 1.3 - 30V variable
- Output Current: 0-1A variable limiting
- Output Regulation: Better than 0.2% zero to full load
- Hum and Noise on Output less than 1mV at full load
- LED's indicate current limiting mode
- Output terminals isolated from chassis

\$39.95

Cat K-3475

FREQUENCY COUNTER KIT

Don't miss this easy-to-build
Pro-Quality digital instrument!

Superb design uses latest IC technology. Low component count makes it very reliable and easy to build. Measures frequencies to 50 MHz (up to 500 MHz with optional pre-scaler) and period — both with a 7 digit resolution. Supplied with the exclusive Dick Smith simplified step-by-step instructions and a quality pre-punched, silk-screened front panel and case.



\$89.95

Cat K-3439

Pre-Scaler Kit

Improve performance & increase range
of Frequency Counter to 10-500 MHz

\$22.50

Cat K-3432

FUNCTION GENERATOR KIT

Now featuring Crystal Time Base
Readout - a great DICK SMITH value!

An essential piece of test & design gear (and an ideal mate for our other build-it-yourself equipment). Produces sine, triangle & square waves from below 20Hz to 1.70kHz [with a wide range of output levels, too]. We haven't room to list all the specs & features here, but we're sure you'll agree this kit is an incredible value!



\$69.95

Cat K-3520

SATELLITE RECEIVER KIT

Over 100 channels are waiting
on Satellite TV - build this
receiver to tune them in!

ONLY \$99.00

Cat K-6316



"What's new in Satellite TV for 1987? A receiver for \$100, it performs as well - or better - than many commercially available receivers. An ideal way to begin assembling your own TVRO system... (you can you think of a better way of adding a second receiver? This receiver will show you it does so build!"

Radio Electronics, January 1986

• Easy to build & tune • Kit is complete to the last nut & bolt • Comprehensive instructions • High Quality Siemens bandpass filter for greater selectivity, reproducibility & stability • Includes "Sorry, Dick It Doesn't Work" Coupon.

Requires 16V AC Power Supply Use Cat M-9558 \$7.95

* Ask about our Antenna Dish, Components, & Satellite TV System packages.

Australis 1 STEREO UPGRADE Kit

MTV, NBC, and more every day - get full matrix of discrete broadcast stereo! Designed especially for our Australis 1 Satellite TV receiver (above), this kit includes everything - but you'll have to hear it to believe it!

\$29.95

Cat K-6317

NEW

CIRCLE 95 ON FREE INFORMATION CARD

RADIO ELECTRONICS Readers' Special

Get this Premium Multimeter at an unbelievably low price!

Not just the usual voltage, current & resistance ranges—it checks capacitors, transistors & diodes, measures transistor gain. Also features audible continuity check, automatic zero of all ranges and more!

JUST \$49

Cat Q-1500

Offer valid until June 30, 1986

- 33 ranges • High accuracy • 10M input impedance • High surge voltage protection • High current measurement (10 AC & DC)

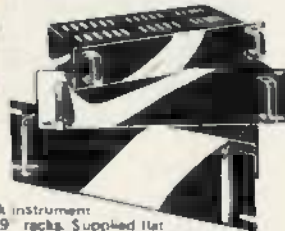

Rack-Mounting Cabinets

Professional quality black instrument cases that fit standard 19" racks. Supplied flat assembly takes only minutes. Heavy gauge (0.12") front panel, top & bottom pre-punched for ventilation.

- Cat H-2483 16.75" x 9.8" x 1.5" **\$24.95**
- Cat H-2482 16.75" x 9.8" x 3.25" **\$27.50**
- Cat H-2484 16.75" x 9.8" x 5.5" **\$29.95**

This Month Only **SAVE \$50** off last year's price!



LASER EXPERIMENTER'S HANDBOOK

Frank McAleese, 210 pages

A hands-on guide to understanding & applying modern laser technology. All the background theory needed to build actual working lasers. **\$9.95** Cat B-3900

FIBEROPTICS & LASERS

Edward L. Safford Jr., 356pp

Whether you're an engineer looking for a thorough overview of the field, or simply curious about these space-age developments, this is the book. **\$16.95** Cat B-3810

Electronic Telephone Projects

Anthony Castelli, 168 pp.

From basic principles & construction techniques to exciting projects like soft tone bell, phone sentry, auto recorder & more! **\$8.95** Cat B-2005

Cheap Video Cookbook

Don Lancaster, 256 pp.

Get words, pictures & opcodes out of a computer & onto an ordinary TV. Includes construction details & software. **\$8.95** Cat B-3985

Electronic Test Gear to Build

Over 40 easy projects for hobbyists & enthusiasts: frequency meters, oscillators, power supplies & more. **\$3.95** Cat B-3638

DSE MAGAZINE BINDER

Store up to 12 issues (up to 8 1/2" x 11 size) in this strong, handsome binder! **\$4.95** Cat B-4045

DSE Designer Boards

Now designing is so simple! No soldering, no mess, and each board comes with a pad of layout paper.

- Cat P-4614 3" x 2 1/4" x 3" **\$4.99**
- Cat P-4615 7" x 2 7/8" x 3" **\$9.95**
- Cat P-4616 8" x 6 1/2" x 3" **\$18.95**
- Cat P-4617 8" x 8 3/4" x 8" **\$29.95**

Jumper Wire Kit

Pre-cut pre-stripped, & pre-formed—use with Bus Strips, Proto Boards, DSE Designer Boards & more! 22 AWG color-coded lengths: 50 ea. 3/16", 25 ea. of 1/2" lengths from 5/16" to 1/2" comes in clear plastic case with cover. **\$12.95** Cat K-4650

Cat W-4652 Economy Assortment (no case) \$4.95

Photo-Etch™ PCB Kit

Make your own PCB's directly from magazine art! All necessary materials included: 5" x 8" steel print frame, film & processing pack, yellow filter, etch resist, developer, blank copper boards, dry concentrated etch, 1:1 resist phenomena, tapes & instructions. **\$34.95** Cat H-5700

Cat S-3905 Exposure Light for Photo-Etch \$41.95

Circuit-Fix™ Kit

Your board missing a track? No worries! Make circuit repairs & changes fast & simple. Includes spring-loaded clamp & guide, collet knife & blade, 154 assist copper donuts, 32 sq.in. foil & instructions. **\$21.95** Cat H-5900

Tinnit™

Solder won't stick? Tinnit plates bare copper circuit boards (and other metals) to enhance solderability. **GREAT VALUE!**

- Cat H-5730 1 pint **\$3.99**
- Cat H-5731 1/2 gallon **\$14.95**

Gel Cells

No mess, no leaks! Now available in four sizes.

- Cat S-3313 8V/1.2 Ah **\$6.95**
- Cat S-3315 12V/1.2 Ah **\$7.99**
- Cat S-3320 12V/3 Ah **\$13.95**
- Cat S-3321 12V/9Ah **\$34.95**

Ni-Cad Charger

Suits most sizes & types of Ni-Cad batteries. Test meter & 5 LEDs. **\$9.95** Cat M-9519

\$9.95 Cat M-9519

\$9.95 Cat M-9519

\$9.95 Cat M-9519

\$9.95 Cat M-9519

\$9.95 Cat M-9519

\$9.95 Cat M-9519

\$9.95 Cat M-9519

\$9.95 Cat M-9519

\$9.95 Cat M-9519

\$9.95 Cat M-9519

\$9.95 Cat M-9519

\$9.95 Cat M-9519

\$9.95 Cat M-9519

\$9.95 Cat M-9519

TEST EQUIPMENT

20MHz Dual Trace Oscilloscope

now only **\$329.00** Cat Q-1240

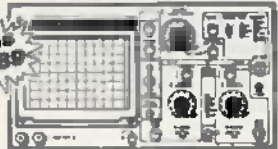

A feature-packed value: high brightness CRT, special component testing circuit, wide bandwidth, high sensitivity, low power consumption, regulated power supply and much more - a new low price!

Troubleshooting with an Oscilloscope R.G. Middleton, 4th edition **\$11.95** Cat B-2002



Audio Oscillator

\$69 Cat Q-1220

A hand-held unit the size of a digital multimeter. 23 ranges of sine & square waves and more! 48 settings in all.

Deluxe 3.5 Digit LCD Multimeter

\$99.95 Cat Q-1342

Our newest & best! Includes temp. sensor, caps. meter, transistor tester - a whole workshop in a portable multimeter!

Economy Multimeter

It was the best value available at its original price. Now you can have this quality instrument for even less! **\$21.95** Cat Q-1440

Price Slashed!



\$14.95 EACH

Emergency strobe lights at an incredibly low price! Bright neon flash tube is great for light aircraft, boats, alarms, vehicles, or special effects. Requires 12 V power source, available in 4 colors. Cat L-6000 Blue, Cat L-6001 Green, Cat L-6002 Red, Cat L-6003 Clear

POWER & MUCH MORE!

3-6-9-12V DC @ 1 amp



Plugs into 117V AC power socket. DC connections. Ideal for alarms, inter-coms, etc. **\$13.95** Cat M-9530

13.8 V 5A Peak Power Supply



Regulated DC supply for home, lab, service bench, CB, stereo & auto radios. 3 amp continuous. **\$19.95** Cat M-9545

20 amp Supply Cat M-9547 **\$99.95**



NOW OPEN IN L.A.

WHERE THE ELECTRONIC ENTHUSIAST IS # 1!
DICK SMITH ELECTRONICS

Orders Only — Call Toll Free:
1-800-332-5373
(Monday-Friday, 7am-6pm PACIFIC TIME)
IN CALIFORNIA CALL: 1-415-368-1068

- STORES AT:
- BERKELEY: 2474 Shattuck Ave. (415)486-0755
 - REDWOOD CITY: 390 Convention Way (415)368-8844
 - SAN JOSE: 4980 Stevens Creek Blvd (408)241-2266
 - LOS ANGELES: 1830 Westwood Blvd (213)474-0629
 - HEAD OFFICE: 390 Convention Way, Redwood City, CA 94063

MAIL ORDERS
P.O. Box 8021 Redwood City CA 94063
14 DAY MONEY-BACK GUARANTEE
SHIPPING & HANDLING:

PLEASE RESERVE MY COPY of the 1986 DICK SMITH ELECTRONICS Catalog! Enclosed is \$1.00 for postage & handling.

YES! NAME _____ ADDRESS _____ CITY _____ STATE _____ ZIP _____



Don't Miss Our 1986/7 CATALOG

More pages, more products! Hit off the press, with everything for the electronics enthusiast. The data section alone is worth the price of admission. Send your copy today!

STEREO AMP

continued from page 68

Switches S8 and S9 in the *Dubbing Select Circuit* operate similarly to the other switches in that section, except that they drive a 4013 "D" flip-flop, rather than an RS flip-flop built from gates. The RC networks connected to S8 and S9 debounce those switches. The outputs of those flip-flops are connected to the tape buffer circuit shown in Fig. 4.

The flip-flops in the *Dubbing Select Circuit* drive the A and B inputs of IC104 and IC204, triple SPDT analog switches that route the tape-recorder input and output signals to the appropriate places.

We should mention that the Q output of each flip-flop in the *Dubbing Select Circuit* controls the RESET input of the other flip-flop. That cross connection makes it necessary, when using the dubbing circuit, to turn off a circuit before turning on the opposite one. For example, if you're dubbing from Tape 2 to Tape 1 and want to reverse the operation, you'll have to press

the 2-1 switch before pressing the 1-2 switch.

Next time, we'll finish up our discussion of the circuit's theory and then begin to build the unit. R-E

CLICK AND POP

continued from page 57

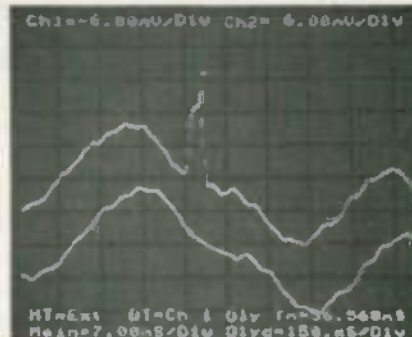

FIG. 11—THE UPPER TRACE SHOWS an input signal with a large scratch pulse; the lower trace shows how that scratch is removed, and how a smooth transition is made between the "from" and "to" portions of the waveform.

sound of both new and old record albums. A good record cleaner is probably the cheapest and most effective means of sound improvement. But beyond that, our Scratch Filter can provide such a dramatic improvement in sound that you'll wonder how you ever got along without it. The photo shown in Fig. 11 shows the kind of real-life performance you can expect from the device. Happy listening! R-E

cable tv DESCRAMBLER PARTS!

We stock the exact parts, PC board and AC adaptor for Radio Electronics February 1984 article on building your own Cable TV Descrambler.

- #701 **PARTS PACKAGE** \$29.95
Includes all the original resistors, capacitors, diodes, transistors, integrated circuits, coils, IF transformers (also BKAN-K5552AXX).
- #702 **PC BOARD** \$12.95
Original etched & drilled silk-screened PC board used in the article.
- #704 **AC ADAPTOR** \$12.95
Original (14 volts DC @ 285ma) ac adaptor used in the article.

SPECIALS

- BOTH #701 & #702 NOW \$39
- ALL THREE #701, #702 & #704 NOW \$49

Add \$2.50 shipping and handling — \$4.50 for Canadian orders
We also offer quantity Discounts on 5 or more units

FREE Reprint of Radio Electronics article (February 1984) on Building Your Own CABLE TV DESCRAMBLER with any purchase of above.

60-CHANNEL
CABLE CONVERTER
WITH INFRARED REMOTE CONTROL



SC-60R CONVERTER \$69.95

Thousands of these converters sold nationally for \$119.95. We offer you the same 1994 all converter for only \$69.95. All converters are NEW with full manufacturer's WARRANTY.

FEATURES

- Full 60 Channel Capability
- Cordless infrared remote control
- Ultra-Stable Synthesized Tuning
- Infrared-secure controlled PLS
- Works on all TV models, channel 3 output
- Standard HRC Switch for compatibility with all Cable Systems
- Will work with all types of external descramblers

Add \$3.50 Shipping And Handling
\$4.50 on Canadian Orders

**ORDER
TOLL FREE
1-800-227-8529**



inside MA 617-339-5372
VISA, MASTERCARD or C.O.D.



**J & W
ELECTRONICS, INC.**

P.O. BOX 800-D • MANSFIELD, MA 02048

CIRCLE 65 ON FREE INFORMATION CARD

Fact:

Cardiovascular diseases will cause half of all deaths this year.

Your gift can make a difference.



American Heart Association

WE'RE FIGHTING FOR YOUR LIFE

Radio Shack Parts Place

HOBBY ELECTRONICS VALUES AT OUR STORE NEAR YOU

Beautify Your Project!

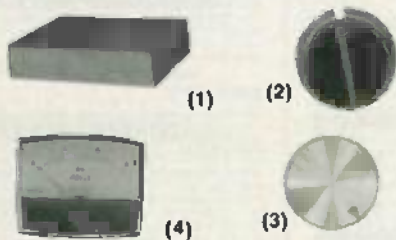

- (1) Deluxe Enclosure. Easy-to-work metal with eggshell white bottoms, black tops, hardware, rubber feet. 1³/₁₆" x 8¹/₄" x 6¹/₂". #270-272 5.99
Larger Version, 3¹/₁₆" x 8¹/₄" x 6¹/₂". #270-274 7.99
- (2) Communications Knobs. 1¹/₂" diameter. Painter notch #274-402 Pkg. of 2/99c
- (3) Contemporary Knobs. 1" diameter. Metal over plastic. #274-424 Pkg. of 2/1.89
- (4) 0-15 VDC Panel Meter. #270-1754 7.95

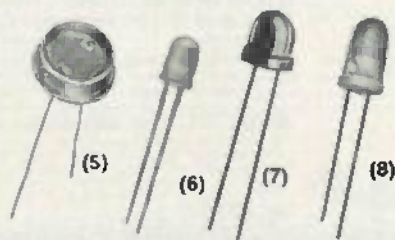

- (5) CdS Photocell. Rated 200 mW at 170 volts, max. #276-116 1.29
- (6) KC-5491 Tri-Color LED. Glows red on DC, green on reverse DC, yellow on AC. #276-035 1.29
- (7) COX21 Blinking LED. Combines a MOS driver IC and a red LED in one housing. Use as an alerter or in electronic jewelry. #276-036. 1.59
- (8) Super-Bright Red LED. 300 mcd at 20 mA, yet runs cool. #276-066 99c

Semiconductor "Hotline"

Now Radio Shack Can Replace Almost Any IC or Semiconductor

More Than 200,000 Substitutions!

- No Minimum Order
- No Postage Charge



If the device you need is not part of our regular stock, we'll check our new in-store substitution guide and special-order a replacement from our warehouse. Semiconductors are available for projects and repair work. Radio Shack also offers this service on selected tubes, crystals, phono cartridges and stylus. Come in and give us a try!

Battery Guidebook

Helps You Select The Right Battery

1.99



Learn how batteries work, how to recharge and test them, and how to choose the best values. Includes complete technical data on all ENERCELL® batteries. 160 pages. #62-1396

"Soft-Touch" Switches



Low As 1.19

- SPST "Soft-Touch" Push-On/Off Switch. Rated 3 amps at 125 VAC. Mounts in a 3/16" diameter hole. #275-1565 1.29
- Momentary Version. #275-1566 1.19

Get "Motorvated"!



SPECIAL PURCHASE! 2 for 1.49

These small low-voltage DC motors are reversible and have a prewired noise-suppression circuit. They are ideal for robotics, experiments, model-making and just plain fun. About 2¹/₂" x 1¹/₂". Shaft has a brass pulley. #273-229.

Semiconductor Reference Guide

1986 Edition 3.99



Packed with detailed information on Radio Shack's ICs, SCRs, LEDs diodes and opto devices. Cross-reference and substitution section lists over 80,000 types. Illustrated. 254 pages. #276-4009

Sound the Alarm!



- (9) Two-Tone Piezo Buzzer. Super-loud 100 dB output, ideal for security systems, power failure alerters and more. 8 to 16 VDC. #273-070. 8.95
- (10) Pulsing/Continuous Piezo Buzzer. Great for alarm systems, vehicle backup alerts. Output: 90 dB at 12 VDC, only 10 mA. Screwdriver terminals. #273-068 6.95

Etch Your Own Boards



Our PC Board Kit includes everything you need: Two 4¹/₂" x 3" solid copper-clad boards, resist-ink pen and solvent, etchant, layout strips and circles, tank, 1/16" drill bit and instructions. #276-1576 9.95

Breadboard It!

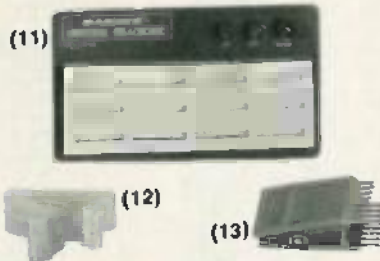

- (11) Universal Breadboard. Our best! The 2¹/₄" x 6¹/₂" breadboard is mounted on a 7 x 4" "stay-put" steel base with rubber feet. Accepts DIPs, discretes and up to 22-gauge wire. Has 3 binding posts for external hookups. #276-169 19.95
- (12) 16-Pin DIP Jumper. #276-1976 3.99
- (13) 16-Position DIP Test Clip. Easy access to individual pins. #276-1982 3.99

Folding 16-Range LCD Digital Multimeter



Automatic Shut-Off When Case Is Closed
Automatic Polarity

New! 49.95

This extra-durable Micronta® instrument measures AC/DC volts, DC current, resistance and has a special mode for testing semiconductor junctions. The hinge has detented "stop" positions at 90, 135 and 180° for easy viewing on your bench and in the field. With spare fuse, test leads, owner's manual. Batteries extra. #22-187

TV Sound/Video Modulator

Sale! 2.88

Reg. 4.95

Prewired module converts line-level video and audio signals to channel 3 or 4 for reception on a standard TV. Can be used with computers, TV cameras, and in experiments. 12 VDC. #277-1015



Handy Transistor checker

Only 14.95



Tests small-signal and power-type bipolar transistors in or out of circuit. Lamp indicates relative current gain, "opens" and "shorts". Output jack lets you connect to an external meter or scope. With instructions. Battery extra. #22-025

Over 1000 items in stock: Binding posts, Books, Breadboards, Buzzers, Capacitors, Chokes, Clips, Connectors, Fuses, Hardware, ICs, Jacks, Knobs, Lamps, Multimeters, PC Boards, Plugs, Rectifiers, Relays, Resistors, Switches, Tools, Transformers, Transistors, Wire, Zeners and more!

Radio Shack

A DIVISION OF TAYDY CORPORATION

Prices apply at participating Radio Shack stores and dealers

CIRCLE 78 ON FREE INFORMATION CARD

JUNE 1986

9

7400

Part No.	Price	Part No.	Price
SN7400N	19	SN7488N	55
SN7402N	19	SN7489N	35
SN7404N	25	SN7489N	195
SN7405N	20	SN7490N	30
SN7406N	20	SN7493N	30
SN7407N	20	SN74121N	70
SN7408N	25	SN74128N	40
SN7410N	18	SN74128N	45
SN7414N	45	SN74128N	40
SN7418N	35	SN74134N	395
SN7417N	30	SN74180N	120
SN7420N	18	SN74154N	120
SN7420N	19	SN74154N	130
SN7432N	20	SN74178N	70
SN7438N	20	SN74174N	50
SN7442N	40	SN74178N	50
SN7444N	60	SN74178N	50
SN7446N	70	SN74181N	195
SN7448N	70	SN74188N	195
SN7448N	70	SN74188N	195
SN7472N	30	SN74221N	80
SN7473N	35	SN74221N	80
SN7474N	30	SN74279N	195
SN7475N	30	SN74365N	50
SN7476N	35	SN74367N	50

74LS

Part No.	Price	Part No.	Price
74LS00	19	74LS185	70
74LS02	19	74LS188	80
74LS04	25	74LS173	40
74LS05	25	74LS174	30
74LS06	20	74LS178	30
74LS07	20	74LS188	395
74LS08	19	74LS181	40
74LS10	19	74LS193	60
74LS14	30	74LS221	80
74LS27	25	74LS240	80
74LS30	19	74LS243	80
74LS32	25	74LS244	70
74LS42	30	74LS245	60
74LS47	80	74LS294	110
74LS73	30	74LS273	70
74LS74	25	74LS279	70
74LS75	20	74LS322	295
74LS76	25	74LS385	30
74LS95	40	74LS387	30
74LS98	25	74LS387	30
74LS99	30	74LS388	30
74LS99	30	74LS373	70
74LS123	40	74LS374	70
74LS135	30	74LS389	70
74LS138	30	74LS590	80
74LS138	30	74LS524	180
74LS154	140	74LS529	240
74LS157	35	74LS540	80
74LS158	35	74LS545	80
74LS163	40	74LS567	80
74LS164	40	74LS568	195

74S/PROMS

Part No.	Price	Part No.	Price
74S00	20	74S188	175
74S04	35	74S188	195
74S08	35	74S188	140
74S10	28	74S240	140
74S32	30	74S244	140
74S74	30	74S253	180
74S74	30	74S267	180
74S86	30	74S288	70
74S124	275	74S373	180
74S174	70	74S374	180
74S175	70	74S472	340

74ALS

Part No.	Price	Part No.	Price
74ALS00	35	74ALS138	80
74ALS02	35	74ALS174	80
74ALS04	35	74ALS178	80
74ALS08	35	74ALS240	80
74ALS10	35	74ALS244	170
74ALS20	35	74ALS245	240
74ALS30	35	74ALS373	195
74ALS32	35	74ALS374	195
74ALS574	55	74ALS573	195

74F

Part No.	Price	Part No.	Price
74F00	50	74F137	120
74F04	65	74F150	120
74F08	50	74F193	495
74F10	50	74F240	240
74F32	65	74F244	240
74F74	60	74F293	170
74F86	60	74F373	205
74F128	110	74F374	205

CD-CMOS

Part No.	Price	Part No.	Price
CD4001	19	CD4091	25
CD4011	19	CD4092	25
CD4013	35	CD4093	30
CD4018	19	CD4094	140
CD4017	80	CD40103	295
CD4020	80	CD4501	80
CD4024	80	CD4511	80
CD4027	30	CD4518	130
CD4030	30	CD4520	70
CD4048	20	CD4532	70
CD4050	20	CD4536	80
CD4051	65	CD4541	80
CD4052	65	CD4543	90
CD4053	65	CD4563	495
CD4058	340	CD4569	30
CD4060	80	CD4599	180
CD4068	20	CD4621	110
CD4089	25	CD4594	50
CD4070	20	CD4595	75
CD4071	25	MC14411	95
CD4072	25	MC14336	440
CD4076	80	MC14572	80

PRICE BREAKTHROUGH!

CUSTOM COMMODORE CHIPS

for VIC-20, C-64 and C-128 Personal Computers

Part No.	Price	Part No.	Price	Part No.	Price
6510CPU	44.00	9.95	6528CIA	26.00	14.95
6525TP	60.00	9.95	6560VIC-I	80.00	14.95
			6567VIC-II	44.00	19.95

*Specs. Available @ \$1.50 ea. NOTE: 828100 = U17 (C-64)

MC68701 - Microcomputer with EPROM

The MC68701 is an 8-bit single chip microcomputer unit (MCU) which intelligently enhances the capabilities of the MC6800 family of parts. On-chip resources include 2048 bytes of EPROM, 128 bytes of RAM, Serial Communications Interface (SCI), parallel I/O and a true function Programmable Timer.

MC68701.....\$24.95

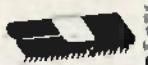

MICROPROCESSOR COMPONENTS

MICROPROCESSOR CHIPS		8500/8600/88000 Cent.		68000 SERIES Cent.	
Part No.	Price	Part No.	Price	Part No.	Price
D76SAC	4.95	80843	9.05	8237-B	6.95
CDP1802CE	9.05	80845	4.95	8243	2.49
2081-3	6.95	80850	1.90	8250A	6.95
		80852	4.75	8250B (For 8088)	7.25
		88000LA	9.95	8251A	2.25
		68661	8.95	8253.5	2.25
				8254	9.95
				8254-B	11.95
				8256A-B	2.25
				8257-5	2.49
				8272	4.95
				8278-B	2.95
				8741	8.95
				8746	7.95
				8749	9.95
				8751	7.95
				8755	14.95

8088/8088/80880 SIL.		8088 SERIES		DATA CONVERTERS	
Part No.	Price	Part No.	Price	Part No.	Price
80802	2.75	8088-2	9.95	ADC0804	3.40
85320	4.95	8118	5.95	ADC0808	6.95
8532	4.95	8186	2.78	ADC0808B	6.95
8532	6.40	8186-2	3.95	ADC0818	14.95
8551	5.95	8188	2.75	ADC0818B	14.95
8600	1.90	8202	9.95	ADC0817	6.95
8602	4.95	8203	29.95	DA00808	1.95
8610	1.95	8212	1.95	DAC1008	7.95
8614	1.95	8228	3.40	AY-5-019D	4.95
8640	6.75	8228	3.40	AY-5-019A	3.95

DYNAMIC RAMS

Part No.	Function	Price
4118N-15	16,384 x 1 (180ns)	80
4128	131,072 x 1 (200ns)	50
4184N-150	65,536 x 1 (180ns)	130
4184N-200	65,536 x 1 (200ns)	130
TM64416-12	16,384 x 4 (120ns)	40
MM5290	4096 x 1 (200ns) 2107	190
6118	16,384 x 1 (180ns) (+8V Only Required)	80
41256-150	131,072 x 1 (180ns)	395
50484-15	65,536 x 4 (180ns) (44484)	790

STATIC RAMS

Part No.	Price	
TM62016-12	2048 x 8 (120ns)	180
2102	1024 x 1 (30ns)	80
2102-2L	1024 x 1 (250ns) LP (91U02)	140
2114N	1024 x 4 (480ns)	90
2114N-2L	1024 x 4 (480ns) LP	120
2114N-4	1024 x 4 (200ns)	108
2114N-2L	1024 x 4 (200ns) LP	140
21C14	1024 x 4 (200ns) CMOS	40
2140	1024 x 4 (48ns)	495
5101	256 x 8 (450ns) CMOS	395
HM6116A-3	2048 x 8 (180ns) CMOS	170
HM6116L-3	2048 x 8 (150ns) LP CMOS	185
HM6264A-12	8192 x 8 (120ns) LP CMOS	400
HM6264L-12	8192 x 8 (120ns) LP CMOS	470
HM6264A-15	8192 x 8 (150ns) CMOS	440
HM6264L-15	8192 x 8 (150ns) LP CMOS	450
6514	1024 x 4 (320ns) CMOS (LPD4444)	440

PROMS/EPROMS

Part No.	Price	
1702A	256 x 8 (190ns)	595
TMS2516	2048 x 8 (450ns) 25V	595
TMS2532	4096 x 8 (450ns) 25V	595
TMS2564	8192 x 8 (450ns) 25V	995
2708	1024 x 8 (450ns)	540
2718	2048 x 8 (450ns) 3 voltages	995
2718-1	2048 x 8 (350ns) 25V	420
27C16	2048 x 8 CMOS	995
2732	4096 x 8 (450ns)	375
2732A-25	4096 x 8 (250ns) 21V	525
2732A-35	4096 x 8 (250ns) 21V	440
2732A-45	4096 x 8 (450ns) 21V	395
27C32	4096 x 8 CMOS	1095
2758	1024 x 8 (450ns) Single +5V	595
2764-20	8192 x 8 (250ns) 21V	525
2764-25	8192 x 8 (250ns) 21V	440
2764A-25	8192 x 8 (250ns) 12.5V	440
2764-45	8192 x 8 (450ns) 21V	395
27C64	8192 x 8 CMOS 21V	595
27128-25	16,384 x 8 (250ns) 21V	495
27128A-25	16,384 x 8 (250ns) 12.5V	595
27256-25	32,768 x 8 (250ns) 256K (12.5V)	1295
27C256-25	32,768 x 8 (250ns) 256K CMOS (12.5V)	1395
88784	8192 x 8 (450ns) 25V	1595
68788	8192 x 8 (350ns) 25V	1695
74S387	256 x 4 PROM O.C.	180
748471	256 x 8 PROM TS	495
62C130	512 x 8 PROM TS	395
62C120	256 x 4 PROM TS	295

LOW PROFILE (TINI) SOCKETS

Part No.	1-8	10-99	100-up
8 pin LP	13	12	11
14 pin LP	15	13	11
18 pin LP	17	15	13
24 pin LP	31	30	29
28 pin LP	39	37	35
40 pin LP	60	46	43

WIRE WRAP SOCKETS (GOLD) LEVEL #3

Part No.	1-8	10-99	100-up
8 pin WWW	55	40	45
14 pin WWW	59	45	50
18 pin WWW	75	60	65
24 pin WWW	119	100	90
28 pin WWW	139	120	110
40 pin WWW	179	160	150

SATELLITE TV DESCRAMBLER

The MM5321 is a TV camera sync generator designed to support the basic sync functions for either color or mono-chrome SES and/or Hi-Fi inserted and camera video recorder applications.

COLOR BURST GATE & SYNC
ALLOW STABLE COLOR OPERATION

MM5321.....\$9.95

DIGITALKALKER™

DT1050 - Applications: Teaching aids, appliances, clocks, automotive microcommunications, language translators, etc. The DT1050 is a standard DIGITAL KALKER encoded with 137 separate and useful words, 2 tones, and 8 different phrase durations. The words and tones have been assigned discrete addresses, making it possible to output single words or words concatenated into phrases or even sentences. The "voice" output of the DT1050 is a highly intelligible male voice.

The DT1050 consists of a Speech Processor Chip, MM54104 (40-pin) and two (2) Speech ROMs MM52184SR1 and MM52184SR2 (24-pin) along with a Master Word List and a recommended schematic diagram on the application sheet.

Part No.	Description	Price
DT1050	DigitalKalk™	\$24.95
MM54104	Processor Chip	\$12.95

DT1057 - Expands the DT1050 vocabulary from 137 words to over 250 words includes two (2) ROMs and speech.

DT1057.....\$11.95

INTERSIL

Part No.	Price	Part No.	Price
FE0202D	12.95	7207AEV/KL	8.40
FE0203D	12.95	7211FL (TTL)	7.95
7108CPL	8.95	7211MFL (Micro)	8.40
7108EV/KL	46.95	7217LJL	10.95
7107CPL	8.95	7217APL	8.95
7107EV/KL	46.95	7224FL	10.95
7207AEV	5.95	7225AEV/KL	90.95

74HC HI-SPEED CMOS

Part No.	Price	Part No.	Price
74HC00	30	74HC175	80
74HC02	30	74HC221	195
74HC04	30	74HC240	130
74HC08	30	74HC244	140
74HC10	30	74HC45	180
74HC14	30	74HC453	70
74HC30	30	74HC459	110
74HC32	45	74HC273	170
74HC74	45	74HC373	140
74HC75	60	74HC374	140
74HC76	60	74HC393	110
74HC85	1.10	74HC595	195
74HC88	50	74HC598	195
74HC123	1.10	74HC4040	110
74HC125	90	74HC4049	70
74HC132			

Worldwide • Since 1974

• QUALITY COMPONENTS • COMPETITIVE PRICING • PROMPT DELIVERY

Mail Order Electronics Worldwide
Jameco
ELECTRONICS

COMMODORE COMPATIBLE ACCESSORIES



RS232 Adapter for VIC-20 and Commodore 64

The JE232CM allows connection of standard serial RS232 printers, modems, etc. to VIC-20 and C-64 (including the S-X-64 Portable). A 4-pole switch allows the inversion of the 4 control lines. Complete installation and operation instructions included.

• Plug-In User Port - Provides Standard RS232 signal levels
• Users 8 signals (Transmit, Receive, Clear to Send, Request to Send, Data Terminal Ready, Data Set Ready)

JE232CM... \$39.95

Voice Synthesizer VIC-20 & C-64 Plug-In - Talking In Minutes!

JE520CM... \$99.95

300 Baud Auto Modem

Mitey-Mo (For C-64)... \$74.95

Parallel Printer Interface

MW350 (For VIC-20, C-64 & C-128)... \$69.95

TRS-80 COMPATIBLE ACCESSORIES

E-X-P-A-N-D TRS-80 MEMORY

All kits come complete with documentation

TRS-80 MODEL I, III

TRS-16K3 200ns (Model III)... \$5.95

TRS-16K4 250ns (Model I)... \$5.49

TRS-80 COLOR AND COLOR II

TRS-64K-2... \$11.95

New models only -

TRS-CoCo... Incl. 2-50464's (4164's)... \$19.95

TRS-80 MODEL 4, 4P

TRS-64K-2... \$11.95

Expands Model 4 from 16K, 64K or Model 4P from 64K, 128K

TRS-64K-2PAL... \$29.95

Expands Model 4 from 64K to 128K

TRS-80 Model 100 • NEC • Olivetti

M1008K... \$29.95 ea. or 3 for \$79.95

TRS-80 Model 100 Expansion

NEC&KR... \$29.95 ea. or 3 for \$79.95

NEC Model PC-8201A Expansion

OM108K... \$29.95 ea. or 3 for \$79.95

Olivetti Model M10 Expansion

TANDY 200

M200R... \$99.95 ea. or 2 for \$189.95

Tandy Model 200 Expansion

PROMETHEUS MODEMS



Intelligent 1200/300 Baud Modem with Real Time Clock/Calendar

The ProModem™ is a Bell 212A (1200/300) intelligent stand-alone modem. Has a command set compatible plus an additional extended command set. Shows with alphanumeric display 0909, RS-232 Stand-Alone Unit.

PM1200... \$299.95

Options for ProModem 1200

PM-COM... \$49.95

ProCom Communications Software. Please specify Operating System: Apple ProDOS or CP/M - IBM: PC DOS or MS DOS

PM-OPS12K... \$129.95

Communications Buffer Option

BUF512K... \$54.95

512K Memory for PM-OPS12K

PM-ALP... \$79.95

Alphanumeric Display for ProModem 1200

PM-SPECIAL #2... \$249.95

Includes PM-OPS12K, BUF512K and PM-ALP

APPLE COMPATIBLE ACCESSORIES

All Apple Cards come complete with instructions. MADE IN THE USA!

16K RAM CARD (Language Card) For Apple II and II+

JE860... \$39.95**

Expand from 48K-64K. Runs AppleSoft, DOS, CP/M and Pascal (ASC-18/MSM-1)

CONTROLLER CARD For Apple II, II+ and II*

JE875... \$49.95

Capable of handling up to two drives. Recommended drive: ADD-514 or ADD-12 (AOC-1)

EXTENDED 80-COLUMN CARD For Apple II*

JE864... \$69.95

JE864 is an extended 80-column/64K RAM Card. Ultra-high resolution capability.

128K RAM CARD For Apple II, II+ and II*

JE868... \$119.95**

Best key software programs are included: Utilities, Diagnostics, Demos, and RAM Disk Emulators for DOS 3.3, CP/M and Apple Pascal. Expand-A-RAM

APPLESURANCE DIAGNOSTIC DISK CONTROLLER CARD For Apple II, II+ and II*

JE877... \$69.95

PREVENTS CRASHES! Test your RAM, ROM, CPU and Disk Drives. DRV-1/AppleSurance II

PARALLEL PRINTER CARD For Apple II, II+ and II*

JE880... \$59.95

Fully compatible with Apple CP/M, Apple Pascal (or FORTRAN), and most other operating systems, and software packages available for Apple II, II+ and II* PWE-1!

PARALLEL/SERIAL 64K BUFFER CARD For Apple II, II+ and II*

JE883... \$79.95

Using the parallel jumper cable supplied, the JE883 will attach to the JE850 (above) parallel Card needed for operation. The JE883 includes a standard parallel input with both parallel and serial (RS232) buffered outputs. P/B Buffer.

APPLE, APPLE II, II+ and II are registered trademarks of Apple Computers.
**When using CP/M, the JE860 and JE864 will only function with Version 2.20 or earlier; PASCAL (JE868) Version 1.1 or earlier.

ADDITIONAL APPLE COMPATIBLE PRODUCTS

APF-1 Cooling Fan with Surge Protection - Key: (s.b.)... \$ 39.95

KHP4007 Switching Power Supply - Key: (s.b.)... \$ 39.95

JE614 Numeric/Alph. Keypad - 11 accessories functions - Key: (el)... \$ 49.95

AMON 12" Green Monitor with Built-in Stand - Reg: (s. B and R)... \$ 99.95

KB-EA1 Apple Keyboard and Case - Key: (el)... \$ 99.95

JES20AP Voice Synthesizer - Plug-In, User Ready - Key: (s.b.)... \$119.95

ADD-12 8 1/2" Half-Height Disk Drive - Key: (s.b.)... \$129.95

ADD-12c 8 1/2" Half-Height Disk Drive - Key: (s.b.)... \$129.95

ADD-514 5 1/4" Full Height Disk Drive - Key: (s.b.)... \$139.95

PM1200A Prometheus Internal Modem - 2 Cards - Key: (s.b.)... \$299.95

PM1200M Prometheus Macintosh Ext. Modem - Key: (Macintosh)... \$349.95

GENERAL APPLICATION POWER SUPPLIES

Power/Mate Corp. REGULATEO POWER SUPPLY

Input: 105-125/210-250VAC @ 47-63Hz - Line regulation: ±0.5% - 3 mounting surfaces - Overvoltage protection - UL recognized - CSA certified

Part No. Output Size (inches) Weight PRICE

EMAS/88 5V @ 3A, 6V @ 2.5A 4 1/2" x 4 1/2" x 2 1/2" 7 lbs. \$29.95

EMAS/9C 5V @ 6A, 6V @ 5A 5 1/2" x 4 1/2" x 2 1/2" 4 lbs. \$39.95

4-CHANNEL SWITCHING POWER SUPPLY

Microprocessor, mini-computer, terminal, medical equipment and process control applications - Input: 90-130VAC, 47-60Hz - Output: ±5VDC @ 5A, -5VDC @ 1A, +12VDC @ 1A, -12VDC @ 1A - Line regulation: ±0.2% - Ripple: 30mV p-p - Load regulation: ±1% - Overcurrent protection - Adjustment: 5v main output - 10% - Size: 6 1/2" x 1 1/2" x 4-1/8" - Weight: 1 1/2 lbs.

FCS-604A... \$59.95

IBM COMPATIBLE ACCESSORIES

83-KEY KEYBOARD

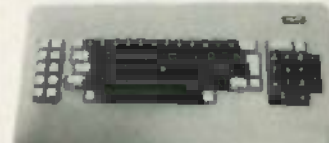

Identical layout as original IBM PC Keyboard - Highly durable case with palm rest - Complete with cable and data - JUST PLUG IN!

KB83... \$49.95

Build an IBM PC/XT* Compatible!

IBM-64K 64K RAM Chips (8)... \$ 12.49

KB-83 83-Key Keyboard... \$ 49.95

IBM-FCC Floppy Controller Card... \$ 54.95

IBM-Cass Cass... \$ 49.95

IBM-MCC Monochrome Card... \$ 89.95

IBM-PS Power Supply... \$ 89.95

FD55B Disk Drive... \$119.95

IBM-MON Monochrome Monitor... \$109.95

IBM-MB Motherboard... \$199.95

Regular List \$777.09

IBM Special (incl. 8 items above)... \$699.95

Additional Add-Ons Available!

IBM-KB 83-Key Keyboard... \$ 79.95

IBM-ENH Enhanced Keyboard... \$ 99.95

IBM-ICB Integrated Color Board... \$109.95

IBM-E384K Multifunction Card... \$169.95

IBM-20MBK 20MB Hard Disk Drive... \$599.95

IBM is a registered trademark of IBM Computers

IBM Compatible DISK DRIVES

Documentation included

FD55B Teac 8 1/2" 5 1/4"-Height... \$119.95

SA455 Shugart 5 1/4" D8 1/4"-Height... \$119.95

TM100-2 Tandon 5 1/4" D8 Full-Height... \$119.95

JMR 5 1/4" DISK DRIVE ENCLOSURES

Complete with power supply switch, power cord, fuseholder and connectors.

DDE-1FH Houses 1 Full-Height 5 1/4" Floppy Drive... \$69.95

DDE-2HH Houses 2 Half-Height 5 1/4" Floppy Drives - Vertical... \$79.95

HDDE-1FH Houses 1 Hard Disk Drive... \$199.95

UV-EPROM ERASER

Erases all EPROMs. Erases up to 8 chips within 21 minutes (1 chip in 15 minutes). Maintains constant exposure distance of 1". Special conductive foam over alternative static build-up. Built-in safety lock to prevent UV exposure. Compact - 8 DDT, a 3.70" x 2.60". Complete with holding tray for 8 chips.

DE-4 UV-EPROM Eraser... \$74.95

UVS-11EL Replacement Bulb... \$17.95

DATA BOOKS

30003 National Linear Data Book (82)... \$14.95

30009 Interall Data Book (85)... \$ 9.95

30013 Zilog Data Book (85)... \$14.95

30022 Nat'l Logic Data Book Set (84)... \$24.95

210830 Intel Memory Handbook (83/84)... \$19.95

230843 Intel Microsystem Handbook (83/84)... \$19.95

MUFFIN/SPRITE-STYLE FANS

MUF60 (SPK-15-2442)... \$8.95

Howard Industries (4.65" sq. 60 cfm)

SU2C7... \$9.95

EQ&G Reatron (3.125" square, 20 cfm)

\$20 Minimum Order - U.S. Funds Only
Shipping: Add 5% plus \$1.50 Insurance

California Residents: Add 6% or 6 1/2% Sales Tax

Spec. Sheets - 30c each
Prices Subject to Change

Send stamped, self-addressed envelope to receive a Quarterly Sales Flyer - FREE!

6/86



Send \$1.00 Postage for a FREE 1986 JAMECO CATALOG

1355 SHOREWAY ROAD, BELMONT, CA 94002 • PHONE ORDERS WELCOME 415-592-8097 Telex: 176043

CIRCLE 114 ON FREE INFORMATION CARD

www.americanradiohistory.com

BUILD A COMPLETE 256K XT SYSTEM—\$717

STATIC RAMS

2101	256x4 (450ns)	1.95
9101	256x4 (450ns)(CMOS)	3.95
2102L-4	1024x1 (450ns)(LP)	.80
2102L-2	1024x1 (250ns)(LP)	1.49
2112	256x4 (450ns)	2.99
2114	1024x4 (450ns)	.99
2114L-4	1024x4 (450ns)(LP)	1.49
2114L-2	1024x4 (200ns)(LP)	1.49
2114L-15	1024x4 (150ns)(LP)	1.95
TM64044-4	4096x1 (450ns)	1.95
TM64044-150	2048x8 (150ns)	1.49
TM64016-100	2048x8 (100ns)	1.95
MM6118-4	2048x8 (200ns)(CMOS)	1.99
MM6118-3	2048x8 (150ns)(CMOS)	1.49
MM6118LP-4	2048x8 (200ns)(CMOS)(LP)	1.49
MM6118LP-3	2048x8 (150ns)(CMOS)(LP)	1.88
MM6118LP-2	2048x8 (120ns)(CMOS)(LP)	2.95
MM6264P-15	8192x8 (150ns)(CMOS)	3.89
MM6264LP-15	8192x8 (150ns)(CMOS)(LP)	3.95
MM6264LP-12	8192x8 (120ns)(CMOS)(LP)	4.49

LP—Low power

DYNAMIC RAMS

4116-250	16384x1 (250ns)	.49
4116-200	16384x1 (200ns)	.69
4116-150	16384x1 (150ns)	.89
4116-120	16384x1 (120ns)	1.49
MM4332	32768x1 (200ns)	6.95
4164-200	65536x1 (200ns)(SW)	1.19
4164-150	65536x1 (150ns)(SW)	1.29
4164-120	65536x1 (120ns)(SW)	1.95
MCM6666	65536x1 (200ns)(SW)	1.95
TMS4164	65536x1 (150ns)(SW)	1.95
6164-REFRESH	65536x1 (150ns)(SW)(REFRESH)	2.88
TMS4416	16384x4 (150ns)(SW)	1.95
41128-150	131072x1 (150ns)(SW)	8.96
41256-200	262144x1 (200ns)(SW)	2.96
41256-150	262144x1 (150ns)(SW)	2.96

SW—Single 5 Volt Supply
REFRESH—Pm 1 Refresh

★★★HIGH-TECH★★★

NEC V20 UPD70108 \$1495

REPLACES 8088 TO SPEED UP IBM PC 10-40%

- HIGH-SPEED ADDRESS CALCULATION IN HARDWARE
- PIN COMPATIBLE WITH 8088
- SUPERSET OF 8088 INSTRUCTION SET
- LOW POWER CMOS

8MHZ V20 UPD70108-8 \$24.95

8MHZ V30 UPD70116-8 \$26.95

★★★SPOTLIGHT★★★

EPROMS

2708	1024x8 (450ns)	3.95
2716-6	2048x8 (650ns)	2.29
2716	2048x8 (450ns)(5V)	3.49
2716-1	2048x8 (350ns)(5V)	3.95
TM52532	4096x8 (450ns)(5V)	3.95
2732	4096x8 (450ns)(5V)	3.89
2732A	4096x8 (250ns)(5V)(21V PGM)	3.95
2732A-2	4096x8 (350ns)(5V)(21V PGM)	4.25
27C64	8192x8 (250ns)(5V)(CMOS)	3.49
2764	8192x8 (450ns)(5V)	4.25
2764-250	8192x8 (250ns)(5V)	3.95
2764-200	8192x8 (200ns)(5V)	4.29
TM52564	8192x8 (450ns)(5V)	8.95
MCM68766	8192x8 (350ns)(5V)(24 PIN)	17.95
27128	16384x8 (250ns)(5V)	6.25
27C256	32768x8 (250ns)(5V)(CMOS)	12.95
27256	32768x8 (450ns)(5V)	7.49

5V—Single 5 Volt Supply
21V PGM—Program at 21 Volts

ORDER TOLL FREE 800-538-5000



SPECTRONICS CORPORATION EPROM ERASERS



Model	Toner	Capacity Chip	Intensity (uW/cm²)	Unit Price
PE-16	NO	8	8,000	\$83.00
PE-16T	YES	8	8,000	\$118.00
PE-24T	YES	12	8,000	\$176.00

8000

8035	1.49
8039	1.95
8080	2.49
8085	2.49
8087-2	169.95
8087	129.00
8088	6.95
8088-2	9.95
8155	2.49
8155-2	3.95
8748	7.95
8755	19.95
80266	129.95
80287	199.95

6500

5502	2.79
85C02 CMOS	12.95
6507	3.95
6520	1.95
6522	4.95
6526	26.95
6532	6.95
6545	6.95
6551	5.95
6561	19.95
6581	34.95

2.0 MHZ

6502A	2.95
6520A	2.95
6522A	11.95
6532A	7.95
6545A	7.95
6551A	6.95

3.0 MHZ

6502B	8.95
-------	------

6800

6800	1.95
6802	4.95
6803	3.95
6809	5.99
6809E	5.95
6810	1.99
6820	2.95
6821	1.95
6822	6.95
6843	19.95
6844	12.95
6845	4.95
6847	13.95
6850	1.95
6883	22.95

2.0 MHZ

68800	4.95
68802	5.95
68809E	8.88
68809	6.45
68821	3.80
68845	6.75
68850	5.95
68854	7.99

CLOCK CIRCUITS

MM5369	1.95
MM5369-EST	1.95
MM58167	12.95
MM58174	11.95
MSM5832	2.95

CRT CONTROLLERS

6845	4.95
6845A	8.95
6507	3.95
HD48505SP	6.95
MC1372	2.95
6275	26.95
7220	19.95
CR15027	12.95
CR15037	9.95
TM99918A	19.95

DISK CONTROLLERS

1771	4.95
1791	8.95
1793	9.95
1795	12.95
1797	18.95
2791	18.95
2793	18.95
2797	29.95
6843	19.95
6844	32.00
6845	4.95
UPD7865	4.95
M88878	12.95
M88877	12.95
1691	6.95
2143	8.95

BIT RATE GENERATORS

MC14811	3.95
BR1541	4.95
4702	3.95
COM8116	8.95
MM5307	4.95

UARTS

AY51013	3.95
AY31015	4.95
TR1602	3.95
7651	4.95
IM8402	4.95
IM8403	4.95
IM84750	6.95

SOUND CHIPS

76477	3.95
76469	8.95
551263	39.95
AY38910	12.95
AY38912	12.95
SP1000	39.00

CRYSTALS

32.768 KHz	.95
1.0 MHz	2.95
1.8432	2.95
3.95	1.95
2.097152	1.98
2.4576	1.95
3.2768	1.95
3.579545	1.95
4.0	1.95
4.032	1.95
9.0	1.98
E0688	1.98
6.164	1.95
8.5536	1.95
8.0	1.95
10.0	1.95
10.738635	1.95
14.31818	1.95
18.0	1.95
18.0	1.95
16.432	1.95
20.0	1.95
22.1164	1.95
24.0	1.95
32.0	1.95

CRYSTAL OSCILLATORS

1.0 MHz	5.95
1.8432	5.95
2.0	5.95
2.4576	5.95
4.0	4.95
4.0	4.98
5.0688	4.95
6.0	4.95
8.0	4.95
8.0	4.95
10.0	4.95
12.0	4.95
12.480	4.95
16.0	4.95
16.432	4.95
20.0	4.95
24.0	4.95

MISC.

TM899531	9.95
TM899532	19.95
ULN2003	7.9
3242	3.95
33A1	4.95
MC3470	1.95
MC3480	8.95
MC3487	2.95
11C90	13.95
2513-001	6.95
AY5-2376	11.95
AY5-3500	11.95

74LS00

74LS00	19
74LS01	18
74LS02	17
74LS03	16
74LS04	16
74LS05	18
74LS08	18
74LS10	18
74LS11	22
74LS12	22
74LS13	26
74LS14	39
74LS15	26
74LS20	17
74LS21	29
74LS22	22
74LS23	23
74LS28	29
74LS30	17
74LS32	18
74LS33	28
74LS34	29
74LS38	26
74LS42	39
74LS47	58
74LS48	69
74LS51	17
74LS73	29
74LS74	24
74LS76	29
74LS78	29
74LS83	49
74LS85	45
74LS86	22
74LS90	39
74LS92	49
74LS93	39
74LS95	49
74LS107	34
74LS109	36
74LS112	29
74LS124	49
74LS124	2.75
74LS125	9.18
74LS126	9.18
74LS132	39
74LS136	39
74LS138	39
74LS147	99
74LS148	89
74LS151	39
74LS153	39
74LS154	149
74LS155	59
74LS155	49
74LS156	149
74LS157	39
74LS160	29
74LS161	39
74LS162	49
74LS183	39
74LS184	49

74LS145

74LS145	99
74LS166	95
74LS169	55
74LS173	49
74LS174	33
74LS179	39
74LS191	49
74LS192	89
74LS193	18
74LS198	69
74LS199	69
74LS195	69
74LS196	69
74LS197	95
74LS221	89
74LS240	69
74LS241	69
74LS242	69
74LS243	69
74LS244	69
74LS245	69
74LS251	49
74LS253	49
74LS256	1.75
74LS258	1.75
74LS258	49
74LS259	1.29
74LS260	49
74LS264	39
74LS273	79
74LS275	99
74LS283	99
74LS290	89
74LS293	89
74LS299	148
74LS322	3.95
74LS322	2.49
74LS364	1.95
74LS365	39
74LS367	39
74LS368	39
74LS373	79
74LS374	79
74LS379	59
74LS378	79
74LS390	9.18
74LS390	9.18
74LS393	79
74LS393	79
74LS441	149
74LS462A	1.95
74LS463	3.20
74LS464	3.20
74LS468	2.40
74LS468	2.40
74LS473	22.95

HIGH SPEED CMOS

A new family of high speed CMOS logic featuring the speed of low power Schottky (TTL) typical gate propagation delay) combined with the advantages of CMOS: very low power consumption, superior noise immunity, and improved output drive.

74HC00

74HC: Operate in CMOS logic levels and are ideal for use in CMOS designs.

74HC00	59
74HC02	88
74HC04	59
74HC08	88
74HC10	59
74HC14	.75
74HC20	.89
74HC27	.59
74HC30	.59
74HC22	.89
74HC51	.59
74HC74	.75
74HC85	1.36
74HC86	.69
74HC93	1.19
74HC107	.79
74HC109	.79
74HC125	.79
74HC125	1.15
74HC132	1.19
74HC133	.89
74HC138	.95
74HC139	.95
74HC148	

PARTIAL LISTING ONLY — CALL FOR A FREE CATALOG

CMDS		
4001	.19	14419 4.95
4011	.18	14433 14.95
4012	.28	4503 .49
4013	.35	4511 .69
4018	.29	4516 .79
4019	.29	4518 .89
4017	.48	4522 .79
4018	.69	4526 .79
4020	.59	4527 1.95
4021	.89	4528 .79
4024	.49	4529 2.95
4025	.25	4532 1.95
4027	.39	4538 .89
4028	.65	4541 1.29
4035	.69	4593 8.79
4040	.69	4585 .75
4041	.75	4702 12.95
4042	.99	74C00 .29
4043	.85	74C14 .69
4044	.69	74C74 .79
4045	1.99	74C83 1.95
4046	.69	74C85 1.49
4047	.69	74C95 .89
4049	.29	74C180 8.75
4050	.29	74C151 2.25
4051	.69	74C181 .95
4052	.69	74C183 .89
4053	.69	74C184 .89
4056	2.18	74C192 1.49
4060	.59	74C193 1.49
4066	.29	74C221 1.75
4069	.19	74C240 1.89
4076	.89	74C244 1.89
4077	.29	74C374 1.95
4081	.22	74C908 10.95
4085	.79	74C911 8.95
4086	.89	74C917 8.95
4093	.49	74C923 4.49
4094	2.49	74C924 7.95
14411	5.95	74C924 4.95
14412	6.95	80C97 .95

7400/9000		
7400	.19	74147 2.49
7402	.19	74148 1.20
7404	.18	74150 1.35
7408	.29	74151 .55
7407	.29	74153 .88
7408	.24	74154 1.49
7410	.29	74155 .75
7411	.25	74157 .55
7414	.49	74159 1.65
7416	.29	74161 .69
7417	.25	74163 .69
7420	.19	74184 .88
7423	.25	74165 .85
7419	.34	74186 1.00
7432	.29	74178 .89
7438	.29	74177 .75
7442	.49	74178 1.18
7445	.69	74181 2.28
7447	.89	74182 .75
7470	.38	74184 2.00
7473	.34	74181 1.15
7474	.33	74182 .89
7475	.48	74194 .88
7476	.39	74196 .78
7483	.50	74197 .75
7485	.69	74199 1.35
7486	.38	74221 1.35
7489	2.18	74246 1.35
7490	.39	74247 1.35
7492	.50	74248 1.88
7493	.38	74249 1.95
7495	.55	74251 .75
7497	2.78	74265 1.35
74100	2.29	74273 1.95
74121	.29	74278 3.11
74123	.49	74197 1.65
74125	.48	74358 .65
74141	.69	9348 3.98
74143	5.95	9602 1.90
74144	2.95	9637 2.95
74145	.60	96502 1.95

74S00		
74S00	.29	74S183 1.29
74S02	.29	74S184 3.95
74S03	.29	74S174 .79
74S04	.29	74S175 .79
74S05	.29	74S188 1.95
74S08	.38	74S189 1.99
74S10	.38	74S196 1.49
74S19	.39	74S197 1.49
74S22	.35	74S226 3.99
74S37	.69	74S240 1.49
74S38	.69	74S241 1.49
74S74	.43	74S244 1.49
74S85	.95	74S257 .79
74S88	.35	74S259 .75
74S112	.50	74S258 .95
74S124	2.75	74S280 1.29
74S138	.77	74S287 1.69
74S140	.55	74S288 1.69
74S151	.79	74S299 2.95
74S183	.79	74S373 1.69
74S157	.79	74S374 1.69
74S158	.95	74S471 4.95
74S161	1.28	74S571 2.95

VOLTAGE REGULATORS		
TO-220 CASE		
7805T	.49	7905T .59
7808T	.49	7908T .59
7812T	.49	7912T .59
7815T	.43	7915T .59
TO-3 CASE		
7805K	1.39	7905K 1.49
7812K	1.19	7912K 1.49
TO-93 CASE		
78L05	.49	79L05 .69
78L12	.49	79L12 1.49
OTHER VOLTAGE REGS		
LM323K	5V 3A	TD-3 4.78
LM328K	Adj SA	TD-3 3.95
78H05M	5V SA	TD-3 7.95
78H12K	12V SA	TD-3 8.95
78P06K	5V 10A	TD-3 14.95

LINEAR		
TL066	.99	LM733 .98
TL071	.69	LM741 .68
TL072	1.09	LM747 .68
TL074	1.95	LM748 .59
TL081	.59	MC1330 1.69
TL082	.99	MC1350 1.19
TL084	1.49	MC1372 8.95
LM301	.34	LM1414 1.59
LM309K	1.26	LM1482 .88
LM311	.59	LM1488 .49
LM311M	.89	LM1489 .49
LM317K	3.49	LM1496 .88
LM317T	.98	LM1812 8.26
LM318	1.88	LM1888 1.95
LM319	1.28	ULN2003 .79
LM320	667900	KR206 3.79
LM322	1.85	KR211 2.95
LM323K	4.79	KR2240 1.96
LM324	.49	MPQ2907 1.95
LM331	3.95	LM2917 1.95
LM334	1.19	CA3046 .89
LM335	1.40	CA3081 .99
LM336	1.78	CA3082 .99
LM337K	2.95	CA3085 8.89
LM338K	3.95	CA3089 1.95
LM339	.39	CA3130E .99
LM340	667800	CA3146 1.29
LM350T	4.80	CA3160 1.18
LF353	.59	MC3470 1.96
LF356	.59	MC3480 8.95
LF357	.59	MC3487 2.95
LM358	.89	LM3900 .96
LM380	.89	LM3909 .98
LM393	1.99	LM3911 2.28
LM386	.89	LM3914 2.39
LM393	.45	MC4024 3.49
LM394H	4.60	MC4044 3.99
TL454	4.20	MC4136 1.25
TL497	3.25	KC4558 6.89
NE555	.29	LM13600 1.48
NE556	.49	78107 1.48
NE558	1.29	75110 1.95
NE564	1.95	78150 1.95
LM565	.95	78154 1.95
LM566	1.49	78188 2.95
LM567	.79	78189 1.28
NE570	2.95	78451 .39
NE590	2.80	78452 .38
NE592	.80	78453 .38
LM710	.75	78477 1.29
LM723	.45	78492 .79
H-T-O-5 CAN. K-T-3 T-T-O-220		

DATA ACQ INTERFACE		
ADC0800	15.55	8T26 1.29
ADC0804	3.48	8T28 1.28
ADC0809	4.45	8T95 .89
ADC0816	14.95	8T96 .89
ADC0837	9.95	8T97 .89
ADC0831	8.95	8T98 .89
DAC0800	4.49	D88131 2.95
DAC0806	1.95	D88304 2.29
DAC0808	2.95	D88331 2.25
DAC1020	8.25	D58835 1.99
DAC1022	5.95	D58836 .99
MC1408LS	2.95	D58837 1.65

IC SOCKETS		
8 PIN ST	1.99	100-
14 PIN ST	.11	.10
16 PIN ST	.12	.11
18 PIN ST	.15	.13
20 PIN ST	.18	.15
22 PIN ST	.19	.12
24 PIN ST	.20	.19
28 PIN ST	.22	.19
40 PIN ST	.30	.22
64 PIN ST	1.95	1.49
ST-SOLDERAIL		
8 PIN WW	.89	.69
14 PIN WW	.89	.82
16 PIN WW	.89	.84
18 PIN WW	.99	.90
20 PIN WW	1.09	.98
22 PIN WW	1.39	1.28
24 PIN WW	1.49	1.38
28 PIN WW	1.69	1.49
40 PIN WW	1.89	1.80
WW-WIREWRAP		
16 PIN ZIF	4.95	CALL
24 PIN ZIF	5.95	CALL
28 PIN ZIF	6.95	CALL
40 PIN ZIF	9.95	CALL
ZIF-TEKTOOL		
ZERO INSERTION FORCE!		

EDGECARD CONNECTORS		
100 PIN ST	\$-100	.125 3.95
100 PIN WW	B-100	.125 4.95
62 PIN ST	IBM PC	.100 1.85
90 PIN ST	APPLE	.100 2.99
44 PIN ST	STD	.156 1.98
44 PIN WW	STD	.156 4.95

36 PIN CENTRONICS		
MALE		
IDCEN36	RIBBON CABLE	6.95
CEN36	SOLDER CUP	4.98
FEMALE		
IDCEN36/F	RIBBON CABLE	7.95
CEN36PC	RT ANGLE PC MOUNT	4.95

INTERFIL		
ICL7105	9.95	
ICL7107	12.95	
ICL7660	2.85	
ICL8038	4.95	
ICM7207A	5.95	
ICM7208	15.95	

DIP CONNECTORS											
DESCRIPTION	ORDER BY	CONTACTS									
		8	16	18	19	20	22	24	28	40	
HIGH RELIABILITY TOOLED ST IC SOCKETS	AUGAT _{ST}	.62	.75	.89	1.09	1.29	1.49	1.68	2.49		
HIGH RELIABILITY TOOLED WW IC SOCKETS	AUGAT _{WW}	1.30	1.80	2.10	2.40	2.80	2.90	3.19	3.70	3.40	
COMPONENT CARRIER (DIP HEADERS)	ICC _{LL}	.49	.54	.68	.89	.99	.99	.99	1.09	1.48	
RIBBON CABLE (DIP PLUGS) (DC)	IDP _{LL}95	.95	1.78	...	2.95



DIODES/OPTO/TRANSISTORS		
1N751	.25	4N25 .88
1N755	.25	4N27 .69
1N4148	25 1.00	4N32 .69
1N4004	10/1.00	4N33 .89
1N5402	.25	4N37 1.19
KBPO4	.85	MCT 2 .59
KBUBA	.96	MCT-8 1.28
MDA990.2	.38	TL111 .99
N2223	.25	2N3906 .10
2N2222	.10	2N4401 .29
2N2905	.90	2N4402 .29
2N2907	.28	2N4403 .25
2N3055	.78	2N6045 1.75
2N3904	.10	TIP31 .49

D-SUBMINIATURE										
DESCRIPTION	ORDER BY	CONTACTS								
		9	15	19	25	37	50			
SOLDER CUP	MALE	DB9M _P	.82	.90	1.28	1.28	1.80	3.48		
	FEMALE	DB9M _F	.96	1.19	1.60	1.50	2.38	8.32		
RIGHT ANGLE PC SOLDER	MALE	DB9M _{PR}	1.20	1.49	...	1.98	2.66	...		
	FEMALE	DB9M _{FR}	1.26	1.55	...	3.00	2.78	...		
WIRE WRAP	MALE	DB9M _{WW}	1.80	2.96	...	3.89	9.60	...		
	FEMALE	DB9M _{WW}	2.70	4.27	...	6.84	9.98	...		
IDC	MALE	IDC9M _P	2.70	2.96	...	3.98	9.70	...		
	FEMALE	IDC9M _F	2.92	3.20	...	4.33	9.78	...		
HOODS	METAL	MM900 _M	1.28	1.28	1.30	1.30		
	GREY	HOOD _{GR}	.88	.6565	.75	.98		

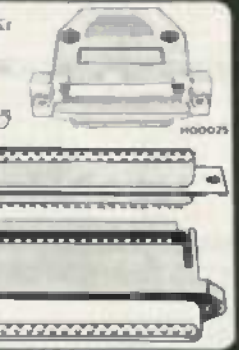

LED DISPLAYS		
FND-357(359)	COM CATHODE	362" 1.28
FND-500(503)	COM CATHODE	5" 1.49
FND-807(810)	COM ANODE	5" 1.49
MAN-72	COM ANODE	3" .99
MAN-74	COM CATHODE	3" .99
MAN-8540	COM CATHODE	5" 1.99
TL1313	COM CATHODE	3" .48
HP5082 7760	COM CATHODE	43" 1.29
TL3131	4x7 HEX W/LOGIC	370" 9.95
HP5082-7340	4x7 HEX W/LOGIC	280" 7.95

IDC CONNECTORS							
DESCRIPTION	ORDER BY	CONTACTS					
		10	20	26	34	40	50
SOLDER HEADER	IDH _{LS}	.82	1.29	1.68	3.20	7.98	3.24
RIGHT ANGLE SOLDER HEADER	IDH _{LSR}	.85	1.38	1.78	2.31	2.72	3.38
WW HEADER	IDH _{LSW}	1.86	2.98	3.84	4.66	9.78	8.63
RIGHT ANGLE WW HEADER	IDH _{LSWR}	2.06	3.28	4.27	5.49	4.09	7.30
RIBBON HEADER SOCKET	IDSR	.79					

ORDER TOLL FREE 800-538-5000

BARGAIN HUNTERS CORNER

- DB25P 100/\$45 10/\$6.90
25 PIN MALE D-SUB CONNECTOR
 - DB25S 100/\$52 10/\$7.90
25 PIN FEMALE D-SUB CONNECTOR
 - HOOD-25 100/\$31 10/\$6.90
PLASTIC HOOD FOR DB25
 - IDE34 100/\$129 10/\$14.90
34 PIN EDGE CONNECTOR
 - AUGAT 16WW 100/\$49 10/\$6.90
16 PIN WIRE WRAP IC SOCKET MACHINE PIN
 - .1uf DISC 1000/\$29.50 100/\$3.95
.1uf 16VOLT CERAMIC DISC CAPACITORS
- SPECIALS END 6/30/86**

PAGE WIRE WRAP WIRE PRECUT ASSORTMENT IN ASSORTED COLORS \$27.50

100ea: 5.5", 6.0", 6.5", 7.0"
250ea: 2.5", 4.5", 6.0"
500ea: 1.0", 1.5", 2.0"

SPOOLS

100 feet \$4.30 250 feet \$7.25
500 feet \$13.25 1000 feet \$21.95

Please specify color.
Blue, Black, Yellow or Red

EMI FILTER \$4.95

- MANUFACTURED BY CDRCOM
- LOW COST
- FITS LC-MP BELOW
- 9 AMP 120 240 VOLT



6 FOOT LINE CORDS

- LC 2 2 CONDUCTOR .39
- LC 3 2 CONDUCTOR .99
- LC MP 3 CONDUCTOR W STD FEMALE SOCKET 1.49

MUFFIN FANS

- 3.15" SQ ROTRON 14.95
- 3.63" SQ ETRI 14.95
- 3.18" SQ MASUSHITA 16.95

WIRE WRAP PROTOTYPE CARDS FR-4 EPOXY GLASS LAMINATE WITH GOLD-PLATED EDGE-CARD FINGERS



IBM PR2 IBM

BOTH CARDS HAVE S/LA SCREENED LEGENDS AND INCLUDES MOUNTING BRACKET

- IBM PR1 WITH -5V AND GROUND PLANE \$27.95
- IBM PR2 AS ABOVE WITH DECODING LAYOUT \$29.95

S-100

- P100-1 BARE - NO FOIL PADS \$15.15
- P100-2 HORIZONTAL BUS \$21.80
- P100-3 VERTICAL BUS \$21.80
- P100-4 SINGLE FOIL PADS PER HOLE \$22.75

APPLE

- PS00-1 BARE - NO FOIL PADS \$18.15
- PS00-3 HORIZONTAL BUS \$22.75
- PS00-4 SINGLE FOIL PADS PER HOLE \$21.80
- 7060-45 FOR APPLE III AUX SLOT \$30.00

SOCKET-WRAP I.O.™

- SLIPS OVER WIRE WRAP PINS
- IDENTIFIES PIN NUMBERS ON WRAP SIDE OF BOARD
- CAN WRITE ON PLASTIC, SUCH AS IC #

PINS	PART#	PCK OF	PRICE
8	IDWRAP 08	10	1.95
14	IDWRAP 14	10	1.95
16	IDWRAP 16	10	1.95
18	IDWRAP 18	5	1.95
20	IDWRAP 20	5	1.95
22	IDWRAP 22	5	1.95
24	IDWRAP 24	5	1.95
28	IDWRAP 28	5	1.95
40	IDWRAP 40	5	1.95

PLEASE ORDER BY NUMBER OF PACKAGES (PCK OF)

FRAME STYLE TRANSFORMERS

12.6V AC CT	2 AMP	5.95
12.6V AC CT	4 AMP	7.95
12.6V AC CT	8 AMP	10.95
25.2V AC CT	2 AMP	7.95

25 PIN D-SUB GENDER CHANGERS \$7.95

SWITCHING POWER SUPPLIES

- PS-IBM \$89.95**
 - FOR IBM PC-XT COMPATIBLE
 - 135 WATTS
 - 5V @ 15A, 12V @ 4.2A
 - 5V @ .8A, -12V @ .5A
 - ONE YEAR WARRANTY
- PS-IBM-150 \$129.95**
 - FOR IBM PC-XT COMPATIBLE
 - 150 WATTS
 - 12V @ 5.2A, -5V @ 16A
 - 12V @ .8A, -5V @ .5A
 - ONE YEAR WARRANTY
- PS-130 \$99.95**
 - 130 WATTS
 - SWITCH ON REAR
 - FOR USE IN OTHER IBM TYPE MACHINES
 - 90 DAY WARRANTY
- PS-A \$49.95**
 - USE TO POWER APPLE TYPE SYSTEMS
 - 5V @ 4A, -12V @ 2.5A
 - 5V @ .8A, -12V @ .5A
 - APPLE POWER CONNECTOR
- PS-SPL200 \$49.95**
 - 5V @ 2.5A, -12V @ 3.5A
 - 5V @ 1A, -12V @ 1A
 - UL APPROVED
 - ALUMINUM ENCLOSURE

CAPACITORS

TANTALUM

1.0uf	15V	.35	47uf	35V	45
8.8	15V	.70	1.0	35V	45
10	15V	80	2.2	35V	55
22	15V	1.35	4.7	35V	80
22	35V	40	10	35V	100

OISC

10uf	50V	.05	680	50V	.05
22	50V	.05	.001uf	50V	.05
27	50V	.05	9022	80V	.05
33	50V	.05	.005	50V	.05
47	50V	.05	.01	50V	.07
68	50V	.05	.02	50V	.07
100	50V	.06	.05	50V	.07
220	50V	.06	.1	12V	10
560	50V	.05	.1	50V	.12

MONOLITHIC

.01uf	50V	.14	.1uf	50V	.18
.047uf	50V	.15	.47uf	50V	.25

ELECTROLYTIC

RADIAL		AXIAL			
1uf	25V	.14	50V	.14	
2.2	35V	.15	10	50V	.15
4.7	50V	.16	22	16V	.14
10	50V	.15	47	50V	.20
47	35V	.18	100	35V	.28
100	16V	.18	220	25V	.30
220	35V	.20	470	50V	.80
470	25V	.30	1000	16V	60
2200	16V	.70	2200	16V	70
4700	25V	1.45	4700	16V	1.25

COMPUTER GRADE 44,000uf 30V 3.95

DATASE EPROM ERASER \$34.95

- ERASES TWO EPROMS IN 10 MINUTES
- COMPACT NO DRAWER
- THIN METAL SHUTTER
- PREVENTS UV LIGHT FROM ESCAPING

1/4 WATT RESISTORS

5% CARBON FILM ALL STANDARD VALUES FROM 1 OHM TO 10 MEG OHM

10 PCS	1000 values	.05	100 PCS	1000 values	.02
50 PCS	1000 values	.025	1000 PCS	1000 values	.018

RESISTOR NETWORKS

SIP 10 PIN	9 RESISTOR	.69
SIP 8 PIN	7 RESISTOR	.59
DIP 16 PIN	8 RESISTOR	1.09
DIP 16 PIN	15 RESISTOR	1.09
DIP 14 PIN	7 RESISTOR	.99
DIP 14 PIN	13 RESISTOR	.99

SPECIALS ON BYPASS CAPACITORS

.01 uF CERAMIC DISC	100/\$5.00
.01 uF MONOLITHIC	100/\$10.00
.1 uF CERAMIC DISC	100/\$6.50
.1 uF MONOLITHIC	100/\$12.50

BOOKS BY STEVE CIARCIA

BUILD YOUR OWN Z80 COMPUTER \$19.95

CIRCUIT CELLAR VOL 1	\$17.95
CIRCUIT CELLAR VOL 2	\$18.95
CIRCUIT CELLAR VOL 3	\$18.95
CIRCUIT CELLAR VOL 4	\$18.95
CIRCUIT CELLAR VOL 5	\$19.95

MICROCOMPUTER HARDWARE HANDBOOK FROM ELCOMP \$14.95

OVER 800 PAGES OF DATA SHEETS ON THE MOST COMMONLY USED ICs INCLUDES TTL, CMOS, 74LS00, MEMORY, CPU's, MPU SUPPORT, AND MUCH MORE!

WISH SOLDERLESS BREADBOARDS

PART NUMBER	DIMENSIONS	DISTRIBUTION STRIPS	TIE POINTS	TERMINAL STRIPS	TIE POINTS	SWINGING POSTS	PRICE
WBU-D	.35 x 0.50"	1	100	---	---	---	2.95
WBU-T	1.35 x 0.50"	---	---	1	630	---	5.95
WBU-204-3	3.94 x 0.45"	1	100	2	1200	2	17.95
WBU-204	5.13 x 0.45"	---	400	2	1200	3	24.95
WBU-205	6.88 x 0.65"	5	500	3	1800	4	29.95
WBU-206	8.25 x 0.45"	7	700	4	2820	4	38.95

LITHIUM BATTERY AS USED IN CLOCK CIRCUITS

3 VOLT BATTERY \$3.95
BATTERY HOLDER \$1.40

NEW EDITION! 1986 IC MASTER THE INDUSTRY STANDARD \$129.95

JDR Microdevices

1224 S. Bascom Avenue, San Jose, CA 95128
Toll Free 800-538-5000 • (408) 995-5430
FAX (408) 275-8415 • Telex 171-110

© COPYRIGHT 1986 JDR MICRODEVICES

VISIT OUR RETAIL STORE LOCATED AT 1256 SOUTH BASCOM AVENUE IN SAN JOSE

HOURS: M-W-F, 9-5 TU-TH, 9-9 SAT, 10-3

PLEASE USE YOUR CUSTOMER NUMBER WHEN ORDERING

TERMS: Minimum order \$10.00. For shipping and handling include \$2.50 for UPS Ground and \$3.50 for UPS Air. Orders over 1 lb. and foreign orders may require additional shipping charges - please contact our sales department for the amount. CA residents must include applicable sales tax. All merchandise is guaranteed for 90 days unless otherwise stated. Items are subject to change without notice. We are not responsible for typographical errors. We reserve the right to limit quantities and to substitute manufacturer. All merchandise subject to prior sale.

PARTIAL LISTING ONLY — CALL FOR A FREE CATALOG

DISK DRIVES FOR APPLE COMPUTERS

AP-150
\$99.95

- 1/2 MT. DIRECT DRIVE
- 100% APPLE COMPATIBLE
- SIX MONTH WARRANTY



BAL-500
\$129.95

- TEAC MECHANISM, DIRECT DRIVE
- 100% APPLE COMPATIBLE
- FULL ONE YEAR WARRANTY



AP-135
\$129.95

- FULL MT SHUGART MECHANISM
- DIRECT REPLACEMENT FOR APPLE DISK II
- SIX MONTH WARRANTY



DOUBLE SIDED!

MAC535
\$249.95

- 3.5" ADD ON DISK DRIVE
- 100% MACINTOSH COMPATIBLE
- DOUBLE SIDED 800K BYTE STORAGE
- HIGH RELIABILITY DRIVE
- HAS AUTO-EJECT MECHANISM
- FULL ONE YEAR WARRANTY



AD-3C
\$139.95

- 100% APPLE IIc COMPATIBLE, READY TO PLUG IN, W/ SHIELDED CABLE & MOLDED 19 PIN CONNECTOR
- FAST, RELIABLE SLIMLINE DIRECT DRIVE
- SIX MONTH WARRANTY



DISK DRIVE ACCESSORIES
FDD CONTROLLER CARD \$49.95
IIc ADAPTOR CABLE \$19.95
ADAPTS STANDARD APPLE DRIVES FOR USE WITH APPLE IIc

KB-1000 **\$79.95**

- CASE WITH KEYBOARD FOR APPLE TYPE MOTHERBOARD
- USER DEFINED FUNCTION KEYS
- NUMERIC KEYPAD WITH CURSOR CONTROL
- CAPS LOCK
- AUTO REPEAT



KEYBOARD-AP **\$49.95**

- REPLACEMENT FOR APPLE II KEYBOARD
- CAPS LOCK KEY, AUTO REPEAT
- ONE KEY ENTRY OF BASIC OR CP/M COMMANDS



EXTENDER CARDS

IBM-PC	\$45.00
IBM-AT	\$68.00
APPLE II	\$45.00
APPLE IIc	\$45.00
MULTIBUS	\$86.00

APPLE COMPATIBLE INTERFACE CARDS

EPROM PROGRAMMER \$59.95

MODEL RP525

- DUPLICATE OR BURN ANY STANDARD 27x4 SERIES EPROM
- EASY TO USE MENU DRIVEN SOFTWARE IS INCLUDED
- MENU SELECTION FOR 2716, 2732, 2732A, 2764 AND 2725
- HIGH SPEED WRITE ALGORITHM
- LED INDICATORS FOR ACTIVITY
- NO EXTERNAL POWER SUPPLY NEEDED
- ONE YEAR WARRANTY

16K RAMCARD \$39.95

- FULL TWO YEAR WARRANTY
- EXPAND YOUR 48K APPLE TO 64K
- USE IN PLACE OF APPLE LANGUAGE CARD

BARE PC CARD W/ INSTRUCTIONS \$8.95

IC TEST CARD \$99.95

- QUICKLY TESTS MANY COMMON ICs
- DISPLAYS PASS OR FAIL
- ONE YEAR WARRANTY
- TESTS: 4000 SERIES CMOS, 74HC SERIES CMOS, 7400, 74LS, 74L, 74H & 74S

300B MODEM \$49.95
FOR APPLE OR IBM

INCLUDES ASCH PRO-EZ SOFTWARE



- FCC APPROVED
- BELL SYSTEMS 103 COMPATIBLE
- INCLUDES AC ADAPTOR
- AUTO DIAL
- DIRECT CONNECT

CABLE FOR APPLE IIc \$14.95

JOYSTICK CR-401 \$7.95

FOR ATARI 400, 800, 2600, VIC 20/64 AND APPLE IIa

DISKFILE
HOLDS 70 5 1/4" DISKETTES



\$895
3.5" DISKFILE HOLDS 40 \$995

POWER STRIP
UL APPROVED
15A CIRCUIT BREAKER
\$12.95



3-WAY SWITCH BOXES

- SERIAL OR PARALLEL
- CONNECTS 3 PRINTERS TO ONE COMPUTER OR VICE VERSA
- ALL LINES SWITCHES
- HIGH QUALITY ROTARY SWITCH MOUNTED ON PCB
- GOLD CONTACTS
- STURDY METAL ENCLOSURE



SWITCH-3P CENTRONICS PARALLEL \$89.95
SWITCH-3S RS232 SERIAL \$89.95

PRINTER BUFFERS

- FREES COMPUTER FOR OTHER TASKS WHILE PRINTING LONG DOCUMENTS
- STAND ALONE DESIGN WORKS WITH ANY COMPUTER OR PRINTER
- ALL MODELS FEATURE PRINT PAUSE MEMORY CHECK, GRAPHICS CAPABILITY

SP120P PARALLEL \$139.95

- 84K UPGRADABLE TO 256K
- LED INDICATOR SHOWS VOLUME OF DATA IN BUFFER

SP120S RS232 SERIAL \$159.95

- 84K UPGRADABLE TO 256K
- 6 SELECTABLE BAUD RATES, FROM 600B - 19,200B

SP110P PARALLEL \$249.95

- 84K UPGRADABLE TO 512K
- SPOOLS OUTPUT OF UP TO 3 COMPUTERS
- LED BAR GRAPH DISPLAYS AMOUNT OF DATA IN BUFFER
- REPEAT FUNCTION: CLEARS DATA IN BUFFER
- REPEAT FUNCTION CAN PRODUCE MULTIPLE COPIES OF A DOCUMENT



NASHUA DISKETTES DEALS

5 1/4" SOFT SECTOR DS/DD WITH HUB RINGS

\$990 **69C ea** **59C ea**
BOX OF 10 BULK QTY 50 BULK QTY 250

NASHUA DISKETTES WERE JUDGED TO HAVE THE HIGHEST POLISH AND RECORDED AMPLITUDE OF ANY DISKETTES TESTED ACCORDING TO "COMPARING FLOPPY DISKS", BYTE 9 84

DISKETTES NASHUA 5 1/4"

N MD20	DS DD SOFT	\$9.90
N MD2F	DS QUAD SOFT	\$34.95
N MD2H	DS HD FOR AT	\$49.95

NASHUA 8"

N FD1	SS DD SOFT	\$27.95
N FD2D	DS DD SOFT	\$34.95

NASHUA 3.5"

N 3 555	3B" SS DD FOR MAC	\$32.95
---------	-------------------	---------

VERBATIM 5 1/4"

V MD1D	SS DD SOFT	\$23.95
V MD2D	DS DD SOFT	\$29.95
V MD110D	SS/DD 10 SECTOR HARD	\$23.95

Sakata 120 CPS DOT MATRIX PRINTER



MODEL SP-1200 \$169.95

- EPSON/IBM COMPATIBLE
- 9 WIRE PRINTHEAD
- 120 CPS BIDIRECTIONAL 80 COL
- FRICTION AND TRACTOR FEED
- PROPORTIONAL SPACING
- CENTRONICS PARALLEL INTERFACE
- 8 CHARACTER SETS AND GRAPHICS

6 FOOT IBM PRINTER CABLE \$9.95
REPLACEMENT RIBBON CARTRIDGE \$19.95

5 1/4" FLOPPY DISK DRIVES

TEAC FD 55B 1/2 MT DS/DD FOR IBM	\$109.95
TEAC FD 55F 1/2 MT DS/QUAD FOR IBM	\$109.95
TEAC FD 55GFV 1/2 MT DS/HD FOR IBM AT	\$184.95
TANDON TM100-2 DS/DD FOR IBM	\$59.95
TANDON TM50-2 1/2 MT DS/DD FOR IBM	\$29.95
MPI B52 DS/DD FOR IBM	\$89.95
QUME QT-142 1/2 MT DS/DD FOR IBM	\$79.95

8" FLOPPY DISK DRIVES

FD 100-B SS/DD (SA/BD) EQUIV	\$119.00
FD 200-B DS/DD (SA/BS) EQUIV	\$159.00

DISK DRIVE ACCESSORIES

TEAC SPECIFICATION MANUAL	\$5.00
TEAC MAINTENANCE MANUAL	\$25.00
1/2 MT MOUNTING HARDWARE	\$2.95
MOUNTING RAILS FOR IBM AT	\$4.95
1/2" POWER CABLE FOR 8" FDDs	\$2.95
5 1/4" FDD POWER CONNECTORS	\$1.19



DISK DRIVE ENCLOSURES

CAB-APPLE APPLE TYPE CABINET W/ OUT POWER SUPPLY	\$24.95
CAB-1FH5 FULL HT 5 1/2" BEIGE CABINET W/ POWER SUPPLY	\$69.95
CAB-2SV5 DUAL SLIMLINE 8 1/2" CABINET W/ POWER SUPPLY	\$49.95
CAB-2SV8 VERTICAL DUAL SLIMLINE 8" CABINET W/ POWER SUPPLY	\$209.95
CAB-2FH8 HORIZONTAL DUAL FULL HT 8" CABINET W/ POWER SUPPLY	\$219.95



TEST EQUIPMENT FROM JDR INSTRUMENTS

DIGITAL MULTIMETER PEN DPM-1000
AUTO RANGING, POLARITY AND DECIMAL!
\$54.95

- LARGE 3.5 DIGIT DISPLAY
- DATA HOLD SWITCH
- FREEZES READING
- FAST, AUDIBLE CONTINUITY TEST
- LOW BATTERY INDICATOR
- OVERLOAD PROTECTION

20MHZ DUAL TRACE OSCILLOSCOPE MODEL 2000 \$389.00
35MHZ DUAL TRACE OSCILLOSCOPE MODEL 3500 \$549.00

FOR MORE INFORMATION ON THE OSCILLOSCOPES, SEE OUR AD ON PAGE 8.

CALL FOR VOLUME QUOTES © COPYRIGHT 1986 JDR MICRODEVICES

CIRCLE 182 ON FREE INFORMATION CARD

JUNE 1986

BUILD A COMPLETE 256K XT SYSTEM—\$717

XT COMPATIBLE MOTHERBOARD

\$159.00

- 4.77 MHz 385 CPU, OPTIONAL 387 CO-PROCESSOR
- 8 EXPANSION SLOTS
- 64K RAM INSTALLED, EXPANDABLE TO 640K ON BOARD MEMORY
- ALL IC'S SOCKETED HIGHEST QUALITY PC BOARD
- ACCEPTS 2764 OR 27128 ROMS

PRO-BIOS \$29.95



20 Mb HARD DISK SYSTEM SEAGATE ST-225 \$489.00

INCLUDES 1/2 LENGTH HD CONTROLLER, CABLES, MOUNTING HARDWARE AND INSTRUCTIONS. ALL DRIVES ARE PRE-TESTED AND COME WITH A ONE YEAR WARRANTY.

IBM COMPATIBLE INTERFACE CARDS ALL WITH A ONE YEAR WARRANTY MULTI I/O FLOPPY CARD \$129.95

PERFECT FOR THE 640K MOTHERBOARD



- 2 DRIVE FLOPPY DISK CONTROLLER
- 1 RS232 SERIAL PORT; OPTIONAL 2nd SERIAL PORT
- PARALLEL PRINTER PORT
- GAME PORT
- CLOCK CALENDAR
- SOFTWARE: CLOCK UTILITIES, RAMDISK, SPOOLER

MULTIFUNCTION CARD \$119.95 ALL THE FEATURES OF AST'S 6 PACK PLUS AT HALF THE PRICE

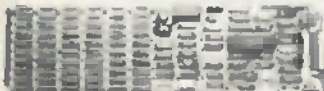

- CLOCK CALENDAR
- 0 384K RAM
- SERIAL PORT
- PARALLEL PORT
- GAME PORT
- SOFTWARE INCLUDED: PRINTER CABLE \$9.95, 64K RAM UPGRADE \$510.71

COLOR GRAPHICS ADAPTOR \$99.95 FULLY COMPATIBLE WITH IBM COLOR CARD



- 4 VIDEO INTERFACES: RGB, COMPOSITE COLOR, HI-RES, COMPOSITE MONOCHROME
- CONNECTOR FOR RF MODULATOR
- COLOR GRAPHICS MODE: 320 x 200
- MONO GRAPHICS MODE: 640 x 200
- LIGHT PEN INTERFACE

MONOCHROME GRAPHICS CARD \$119.95 FULLY COMPATIBLE WITH IBM MONOCHROME ADAPTOR & HERCULES GRAPHICS



- LOTUS COMPATIBLE
- TEXT MODE: 80 x 25
- GRAPHICS MODE: 720 x 348
- PARALLEL PRINTER INTERFACE
- OPTIONAL SERIAL PORT \$19.95

MONOCHROME ADAPTOR \$49.95 ANOTHER FANTASTIC VALUE FROM JDR!

• IBM COMPATIBLE TTL OUTPUT • 720 x 350 PIXEL DISPLAY
PLEASE NOTE: THIS CARD WILL NOT RUN LOTUS GRAPHICS AND DOES NOT INCLUDE A PARALLEL PORT

FLOPPY DISK DRIVE ADAPTOR \$49.95



- INTERFACES UP TO 4 STANDARD FDD'S TO IBM PC OR COMPATIBLES
- INCLUDES CABLE FOR TWO INTERNAL DRIVES
- STANDARD DB37 FOR EXTERNAL DRIVES
- RUNS QUAD DENSITY DRIVES WHEN USED WITH JF FORMAT

EASYDATA 1200 BAUD MODEM FOR IBM INCLUDES PC TALK III COMMUNICATIONS SOFTWARE



- Hayes COMPATIBLE
- AUTO DIAL/AUTO ANSWER
- AUTO RE-DIAL ON BUSY
- INCLUDES SERIAL PORT
- ONE YEAR WARRANTY

\$169.95

CRT MONITORS FOR ALL APPLICATIONS



LUXOR HI-RES RGB MONITOR MODEL 190-0520

- DIGITAL RGB IRM COMPATIBLE
- 14" SCREEN
- 16 TRUE COLORS
- 75 MHz BANDWIDTH
- RESOLUTION: 300 x 282
- 31mm EDD PITCH
- CABLE FOR IBM PC INCLUDED

\$299.95



SAKATA COMPOSITE COLOR MODEL SG-100

- TOP RATED FOR APPLE
- 13" COMPOSITE VIDEO
- RESOLUTION: 280H x 200V
- INTERNAL AUDIO AMP
- ONE YEAR WARRANTY

\$169.95



CENTER SYSTEMS MONOCHROME MODEL KLM-1211

- IBM COMPATIBLE TTL INPUT
- 12" NON GLARE SCREEN
- P39 GREEN PHOSPHORUS
- VERY HIGH RESOLUTION
- 25 MHz BANDWIDTH
- 1100 LINES (CENTER)

\$99.95

BUILD YOUR OWN 256K XT COMPATIBLE SYSTEM

- XT MOTHERBOARD \$159.95
- PRO-BIOS \$29.95
- 256K RAM \$26.55
- 130 WATT POWER SUPPLY \$89.95
- FLIP-TOP CASE \$49.95
- DKM-2000 KEYBOARD \$79.95
- 1/2 HEIGHT QUME DRIVE \$79.95
- FLOPPY DISK CONTROLLER \$49.95
- MONOCHROME ADAPTOR \$49.95
- MONOCHROME MONITOR \$89.95

TOTAL: \$716.10

MONITOR STAND



TILTS AND SWIVELS
ONLY \$12.95

IBM PRINTER CABLE



DB25 TO CENTRONICS
SHIELDED CABLE **\$9.95**

IBM STYLE COMPUTER CASE

AN ATTRACTIVE STEEL CASE WITH A HINGED LID FITS THE POPULAR PC/XT COMPATIBLE MOTHERBOARDS

- SWITCH CUT OUT ON SIDE FOR PC XT STYLE POWER SUPPLY
- CUT OUT FOR 8 EXPANSION SLOTS
- ALL HARDWARE INCLUDED

\$49.95

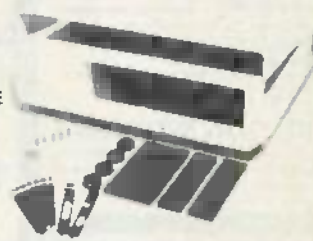

IBM COMPATIBLE KEYBOARDS

DKM-2000 \$79.95

IBM-5151 \$99.95



- "5150" STYLE KEYBOARD
- FULLY IBM COMPATIBLE
- LED STATUS INDICATORS FOR CAPS & NUMBER LOCK
- 83 KEY SAME LAYOUT AS IBM PC XT KEYBOARD



- REPLACEMENT FOR KETRONICS KB-5151
- SEPARATE CURSOR & NUMERIC KEYPAD
- CAPS LOCK & NUMBER LOCK INDICATORS
- IMPROVED KEYBOARD LAYOUT

POWER SUPPLY



NOW ONLY \$89.95

- FOR IBM PC-XT COMPATIBLE
- 135 WATTS
- -5V @ 15A, -12V @ 4.2A
- -5V @ 5A, -12V @ 5A

150 WATT MODEL \$99.95

DISK DRIVES TANDON TM50-2

\$89.95

- 1/2 HT DS/DD
- IBM COMPATIBLE
- EXTREMELY QUIET!

TEAC FD-55B	DS/DD	\$109.95
TEAC FD-55F	DS/QUAD	\$109.95
TEAC FD-55E	DS/HD	\$154.95
DUME DT-142	DS/DD	\$79.95
MOUNTING HARDWARE		\$2.95
AT/RAILS		\$4.95

JDR Microdevices

1224 S. Bascom Avenue, San Jose, CA 95128

Toll Free 800-538-5000 • (408) 995-5430 • FAX (408) 275-8415 • Tele: 171-110

CIRCLE 183 ON FREE INFORMATION CARD

© COPYRIGHT 1986 JDR MICRODEVICES

THE MOST POPULAR PRODUCTS IN EUROPE & ASIA ARE COMING NOW! 50 HOT ITEMS FOR YOUR SELECTION. SEND \$1.00 FOR MARK V CATALOG, REFUND UPON ORDER

CORDLESS SOLDERING IRON RECHARGEABLE

No. 620  **NEW**
The most perfect handy, lightweight soldering iron for Workshop, Home, Hobby & Outdoor work. Includes UL approval charger & cleaning sponge. Will build in solder point illumination.
Each set \$22.99

100W DYNAMIC CLASS "A" MAIN POWER AMPLIFIER

TA-1000A  **NOW PAY LESS!**
This powerful dynamic class "A" circuit makes this unit unique in its class. Crystal clear 100W R.M.S. POWER output will satisfy the most picky Hi-Fi fans. This is a single channel amplifier. If you need a stereo effect you can buy two to make a total of 200W DYNAMIC POWER!
Over 3000 KITS ARE SOLD IN THE STATE!
Ass. with tested \$45.50

10W AC/DC SHOULDER AMPLIFIER TA-008

TA-008 employs the most advanced I.C. of TOSHIBA, as a main device, the sound is powerful, it can be supplied by only 4 pieces of "UL6" 1.5V battery or AC to DC 6-9V adaptor. It is simple in operation, just "press-to-talk", and with ON/OFF power switch on the dial. Besides, while it is well packaged and with light weight, so it is convenient to bring along in both indoor and outdoor activities. Please Read our catalog for details.
Assembled with tested \$48.00

TALKING CLOCK NEW FOR '88

1. Tell: push button for time, temperature of time.
2. Read: 600: weather hours system display for hour, minute, second by color. Read: AM & PM.
3. Display: three display modes of time, alarm time & date.
4. Alarm: on/off switch with thirty minutes delay alarm.
5. Snooze: reminder within alarm of thirty seconds after a minimum of first sleep alarm.
6. Volume: two level of voice output.
7. Language: available English.
Mynah 8884 \$25.99 NOT A KIT!

80W + 80W PURE DC STEREO POWER AMPLIFIER TA-802

Kit \$39.95

COLOR LIGHT CONTROLLER TY-23B

As a result of the advanced technology, this unit can control various colorful light bulbs, the visual effect of which is most suitable in places like party, stage, electronic game centre and also in lightings for advertisement. Total output power is 3000W (1000W/Ch.) which means that it can control 30 pieces of 100W or 800 pieces of 80W color light which is enough for most usages.
Kit \$45.00
Ass. with tested \$75.99

3 1/2 DIGITAL MULTIMETER

YAMATO 4001 **SPECIAL OFFER!**

The YAMATO 4001 is a 3 1/2 DIGIT COMPACT DIGITAL MULTIMETER, it employs FE type LCD, with large figures. Its ADVANTAGES: High accuracy in measuring, high impedance assure min. measuring error. One rotary switch allows test & convenient operation. 36 measurement range enable wider application. Over input indication & low battery life appears on display. LSI-circuit use provides high reliability and durability. Measurement possible even under strong magnetic field.
Not a KIT, as assembled with tested \$32.99

NF-CR BI-FET PRE-AMP TA-2800

 **AMAZING VALUE!**
The heart of this Pre-amplifier is TL-084 IC which contains 4 BI-FET operational amplifier and has very good transient response and low distortion.
High precision NF-CR MM cartridge amplifier has a superior distortion characteristic (less than 0.005%) and RIAA equalization (0.2dB). It reproduces melodical sound.
It has 60 steps volume control, separates high, middle and low tone control, tone compensation and tone delay system.
It is compatible with any power amplifiers which are made by our company such as TA-1000A, TA-477, TA-802.
Kit \$36.80

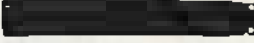
TA-2400A ELECTRONIC ECHO AND REVERBERATION AMPLIFIER

REMIK records yourself!

This unit combines the most advanced computer VLSI technique with high quality Japan Made component, so it has the following FEATURES:
It can generate various reflection and reverb effect such as that in valley and music hall. It has a 3 section effect control which includes reverb-ration control, delay control and depth control. Special effect can be made in your record tapes by using this model. All kinds of inhaled sound effect can be obtained by stable use of this control. It has LED display to show reflection and reverb-ration.
Ass. with tested \$39.95

LCD THERMOMETER CLOCK NEW!

Features:
0.34" DIGITAL thermometer with Hi & Low temperature alarm function and 12 hours clock combination.
Measuring range: 0°F to 180°F or -20°C to +70°C.
Resolution reading: ±1.0°F.
Dimension: 3.2" x 6.88" x 2.08".
T-1 with hi/low sensor \$29.00
T-2 with Fahrenheit/Celsius measuring, \$13.00 NOT A KIT!

STEREO SIMULATOR TA-3000

 **SPECIAL KITS OFFER!**
KIT ONLY \$25.00
You can get a stereo TV from today! This simulator is a special design of using the most advanceable monologous L.S.I. It produced a superior analog stereo effect since the L.S.I. is equalled 90 pct. of LOW NOISE FET & TRANSISTOR. The simulator can even help you to promote your television from a normal one to a special one with a Hi-Fi STEREO function. Our simulator is also applicable to any other "mono sources" in covering it to ANALOG STEREO. Undoubtedly, it is the most advanced equipment for every family, while it should contribute to your listening pleasures.
Ass. with tested \$28.80

HIGH QUALITY MULTIPURPOSE PRE-AMPLIFIER TA-2500

GREAT VALUE!

This specially designed pre-amplifier includes a professional GRAPH EQUALIZER TONE control system and has a gain to 12dB. Frequency response extends from 5Hz to 20KHz, so even in bad listening condition it can improve itself. It can accept input from various magnetic cartridge, record deck and tuner. Its output can be connected to all kinds of power amplifier. The following combinations are good examples.
Assembled with tested \$66.88

Model No.	Description	Kit/Assembled	Unit Price	Model No.	Description	Kit/Assembled	Unit Price
TA-001	1W Mini Amplifier	Kit	\$3.90	TR-255 A, B	3-BA REGULATED DC POWER SUPPLY	Kit	\$10.80
TA-008	6W Mini Amplifier	Kit	\$4.92	TR-803	0-50V/3A POWER SUPPLY WITH SHORT CIRCUIT BREAK & OVERLOAD PROTECTOR	Kit	\$12.30
TA-007	12W Stereo Power Booster	Kit	\$8.00	TR-100	0-15V/2A REGULATED DC POWER SUPPLY	Ass	\$59.50
TA-008	AC/DC SHOULDER AMPLIFIER	Ass	\$48.00			Kit	\$3.99
TA-10	STEREO TO PRE-AMPLIFIER WITH MAGNETIC MIC AMP	Kit	\$6.00	TY-1A MK4	BATTERY FLUORESCENT LIGHT	Kit	\$8.80
TA-50 A, B	MULTI-PURPOSE MELODY GENERATOR	Kit	\$18.78	TY-7	ELECTRONIC TOUCH SWITCH	Kit	\$3.88
TA-120	PURE CLASS "A" MAIN POWER AMPLIFIER	Kit	\$28.00	TY-11A	MULTI-FUNCTIONAL CONTROL RELAY	Kit	\$3.88
TA-202	70W AC/DC STEREO AMPLIFIER	Ass	\$60.00	TY-12A	DIGITAL CLOCK WITH TWO TIMER	Kit	\$13.88
TA-300	30W Multi-Purpose Single Channel Amp.	Kit	\$11.97	TY-13	COLOR LED VU METER	Kit	\$17.80
TA-302	60W Stereo Power Booster	Ass	\$60.00	TY-14	ELECTRONIC SHOCK	Kit	\$3.00
		Kit	\$24.80	TY-18	HIGH PRECISION SOUND CONTROL SWITCH	Kit	\$7.68
TA-322A	High Quality 30W-30W Stereo Amplifier	Kit	\$29.80	TY-20	SUPER SENSITIVE AUDIO LEVEL INDICATOR	Kit	\$19.80
TA-322	50W DC Stereo Pre-Amplifier & Power Amplifier	Ass	\$29.80	TY-23B	COLOR LIGHT CONTROLLER	Ass	\$65.00
TA-400	40W TRANSISTORIZED MONO AMPLIFIER	Kit	\$13.84			Ass	\$75.00
TA-477	120W MOSFET POWER AMPLIFIER	Kit	\$55.00	TY-25	SPEAKER PROTECTOR	Kit	\$8.50
TA-800	150W DC LOW TONE PRE-AMPLIFIER & POWER AMP.	Kit	\$49.95	TY-26	FM WIRELESS MICROPHONE	Kit	\$7.63
TA-802	180W PURE DC ST. POWER AMP. W/SPK. PROTECTOR	Kit	\$28.88	TY-28	AC/DC QUARTZ DIGITAL CLOCK	Kit	\$16.82
TA-820A	60W-60V OCL DC PRE-MAIN & STEREO AMPLIFIER	Kit	\$43.00	TY-30	SOUND OR TOUCH CONTROL SWITCH	Kit	\$10.00
TA-1000A	100W DYNAMIC CLASS "A" MAIN POWER AMP. (MONO)	Kit	\$45.50	TY-41 MKIII	INFRARED REMOTE CONTROL UNIT	Kit	\$26.00
TA-1800	700W NEW CLASS "A" DC STEREO PRE-MAIN AMP	Ass	\$99.85			Ass	\$30.00
TA-2400A	ELECTRONIC ECHO AND REVERBERATION AMP	Ass	\$52.00	TY-42	BAR/DOT LEVEL METER	Kit	\$26.00
TA-2500	HIGH QUALITY MULTI-PURPOSE PRE-AMPLIFIER	Kit	\$38.00	TY-43	BAR/DOT AUDIO LEVEL DISPLAY	Kit	\$34.95
TA-2200	DC FET SUPER CLASS "A" PRE-AMPLIFIER	Kit	\$38.00	TY-47	SUPERIOR ELECTRONIC ROULETTE	Kit	\$18.92
TA-2800	NF-CR BI-FET PRE-AMP WITH 3WAY TONE CONTROL	Ass	\$30.00	YAMATO 4001	3 1/2 DIGITAL MULTIMETER	Ass	\$32.80
TA-3000	STEREO SIMULATOR	Kit	\$25.00	T2	LCD THERMOMETER CLOCK WITH °C MEASURING	Ass	\$18.00
		Kit	\$28.80	B904	TALKING CLOCK MYNAB	Ass	\$28.00
SM-43	3 1/2 MULTI-FUNCTIONAL LED D.P.M.	Kit	\$29.23	B502	TALKING CLOCK COCKATDO	Ass	\$28.00
		Ass	\$33.00	No. 620	CORDLESS SOLDERING IRON RECHARGEABLE	Ass	\$22.80
SM-46	4 1/2 HI PRECISION D.P.M.	Kit	\$38.00			Ass	\$28.00
		Ass	\$43.00			Ass	\$22.80
SM-100	150MC UNIVERSAL DIGITAL FREQUENCY COUNTER	Ass	\$99.00				
TY-43	3 1/2 DIGITAL PANEL METER	Kit	\$28.00				

TERMS:
Min order: \$10.00
Charge card order: \$20.00
NO C. O. D. | Cashier's check, phone orders except.
Call Res. Act. 8.5% Sales Tax.
Prices are subject to change without notice.

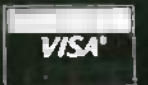
All merchandises are subject to prior sale.
Shipping & Handling: Inside L.A. 5% of total order (Min 1.50). Outside L.A. 10% of total order (Min 2.50). Outside U.S.A. 20% of total order (Min 3.00).
Shipped by UPS



MARK V ELECTRONICS INC
240 E. Main Street, Suite 100
Alhambra, CA 91801
Please mail to:
P.O. Box 7065 ALHAMBRA CA 91802
Telex 3718914 MARK V
In Home Sales (818) 282-1130
Orders (818) 282-1196

HOURS: MON-FRI 10:00 TO 5:00
SATURDAYS 9:00 TO 12:00

TENMA

THE NAME YOU CAN TRUST IN ELECTRONIC TEST EQUIPMENT

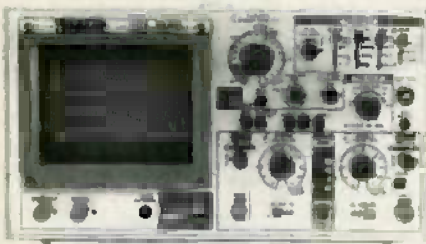

TENMA 35MHz Dual Trace Oscilloscope

- Two high quality 10:1 probes included
- For additional specifications see MCM Catalog #11

#72-330

\$56900
(ea.)



NEW

TENMA 0-18V 3A Power Supply

- Regulated outputs — constant volt or constant current, both are continuously variable
- Can be connected in series or parallel for more voltage or current output
- Reverse polarity and overload protected
- Isolated output

#72-330 Available Mid May!

\$9950
(ea.)



TENMA Combination Function Generator and Frequency Counter

- 6 digit display
- Output range: 2Hz-2MHz: seven ranges
- Counter range: .1Hz-10MHz
- 5-15V TTL and CMOS output
- Wave forms: sine, triangle, square, pulse, and ramp

#72-360

\$21990
(ea.)



NEW



TENMA Frequency Counter

- 8 digit LED display
- Measurement range: 1Hz-120MHz
- High input sensitivity of 20mV RMS

#72-375

\$18995
(ea.)



NEW

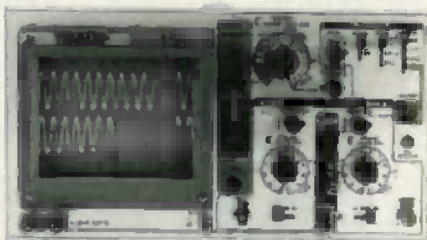

TENMA 20MHz Dual Trace Oscilloscope

- Two high quality 10:1 probes included
- For additional specifications see MCM Catalog #11

#72-320

\$38995
(ea.)

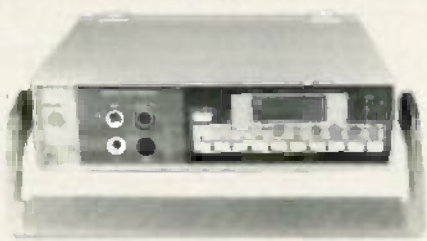

TENMA Bench Top DMM

- 3 1/2 digit
- Eight function DCV, ACV, DCA (up to 20A), ACA (up to 20A), Resistance (up to 20Mohm), Audible continuity test, diode test, capacitance test (up to 20µF)

Available Mid May!

#72-410

\$14980
(ea.)



NEW



NEW

TENMA Rotary Dial DMM

- 3 1/2 digit LCD display
- Rotary dial for rapid selection of functions and ranges
- 20 amp AC-DC current
- .1ohm resolution
- Carrying case included

#72-075

\$44.80 (ea.)

\$4195
(2-up)



NEW

TENMA Digital LCR Meter

- Measures inductance, capacitance and resistance
- L = 1µH-200H, C = .1pF-200µF, R = .01ohm-20Mohm
- Carrying case included

#72-370

\$14995
(ea.)



Be Sure To Call For Your FREE Catalog! Over 6,000 Items!

We also have ... a full line of test equipment, computer accessories, telephone accessories, speakers, television parts, flybacks, yokes, switches, fuses, lamps, capacitors, resistors, cartridges, sniyl, wire, CATV equipment, the largest selection of original Japanese semiconductors in the country and more.

Terms:

- \$10 minimum order \$1.00 charge for orders under \$10
- \$20 minimum charge card order
- Orders shipped UPS C.O.D.
- Most orders shipped within 24 hours
- Sales office open 8:30 am to 7:00 pm Saturdays 10:00 am to 3 pm EST
- For prepaid orders add \$2.75 for shipping and handling
- Should shipping and handling charges exceed \$2.75, the balance due will be sent C.O.D.



MCM ELECTRONICS
858 E. Congress Park Dr.
Centerville, Ohio 45459-4072
(513) 434-0031

SOURCE NO. RE-21

CALL TOLL FREE 1-800-543-4330

In Ohio 1-800-726-4315 • In Alaska and Hawaii 1-800-858-1849

CIRCLE 87 ON FREE INFORMATION CARD



NATIONAL SEMICONDUCTOR • PANASONIC
OK MACHINERY • EWC, INC. • INTERSKILL • AD
EAC, INC. • J. W. MILLER • AAVI ENGINEER
E. F. JOHNSON • ATLANTIC SILICON

256K (262,144 x 1) DRAM 150NS \$5.70/1; \$39.95/9
Factory Firsts

MODES • DRAMING TOOL • UNGAR
ES • CW INDUSTRIE • AMDEK • G & E
P • YAGEO • J. W. MILLER • LUXO
S • CA S • A • PLESSEY



741C SOCKETS

BOLDER TAIL DIP SOCKETS

• Single leads
• Lead profile
• Mount depth: 90.50 mm
• Lead spacing: 2.54 mm
• Lead width: 1.27 mm
• Lead length: 1.27 mm

WIRE WRAP DIP SOCKETS

• Standard profile
• Lead spacing: 2.54 mm
• Lead width: 1.27 mm
• Lead length: 1.27 mm

WIRE WRAP DIP SOCKETS

• Standard profile
• Lead spacing: 2.54 mm
• Lead width: 1.27 mm
• Lead length: 1.27 mm

741C SOCKETS

BOLDER TAIL DIP SOCKETS

• Single leads
• Lead profile
• Mount depth: 90.50 mm
• Lead spacing: 2.54 mm
• Lead width: 1.27 mm
• Lead length: 1.27 mm

WIRE WRAP DIP SOCKETS

• Standard profile
• Lead spacing: 2.54 mm
• Lead width: 1.27 mm
• Lead length: 1.27 mm

WIRE WRAP DIP SOCKETS

• Standard profile
• Lead spacing: 2.54 mm
• Lead width: 1.27 mm
• Lead length: 1.27 mm

741C SOCKETS

BOLDER TAIL DIP SOCKETS

• Single leads
• Lead profile
• Mount depth: 90.50 mm
• Lead spacing: 2.54 mm
• Lead width: 1.27 mm
• Lead length: 1.27 mm

WIRE WRAP DIP SOCKETS

• Standard profile
• Lead spacing: 2.54 mm
• Lead width: 1.27 mm
• Lead length: 1.27 mm

WIRE WRAP DIP SOCKETS

• Standard profile
• Lead spacing: 2.54 mm
• Lead width: 1.27 mm
• Lead length: 1.27 mm

741C SOCKETS

BOLDER TAIL DIP SOCKETS

• Single leads
• Lead profile
• Mount depth: 90.50 mm
• Lead spacing: 2.54 mm
• Lead width: 1.27 mm
• Lead length: 1.27 mm

WIRE WRAP DIP SOCKETS

• Standard profile
• Lead spacing: 2.54 mm
• Lead width: 1.27 mm
• Lead length: 1.27 mm

WIRE WRAP DIP SOCKETS

• Standard profile
• Lead spacing: 2.54 mm
• Lead width: 1.27 mm
• Lead length: 1.27 mm

741C SOCKETS

BOLDER TAIL DIP SOCKETS

• Single leads
• Lead profile
• Mount depth: 90.50 mm
• Lead spacing: 2.54 mm
• Lead width: 1.27 mm
• Lead length: 1.27 mm

WIRE WRAP DIP SOCKETS

• Standard profile
• Lead spacing: 2.54 mm
• Lead width: 1.27 mm
• Lead length: 1.27 mm

WIRE WRAP DIP SOCKETS

• Standard profile
• Lead spacing: 2.54 mm
• Lead width: 1.27 mm
• Lead length: 1.27 mm

741C SOCKETS

BOLDER TAIL DIP SOCKETS

• Single leads
• Lead profile
• Mount depth: 90.50 mm
• Lead spacing: 2.54 mm
• Lead width: 1.27 mm
• Lead length: 1.27 mm

WIRE WRAP DIP SOCKETS

• Standard profile
• Lead spacing: 2.54 mm
• Lead width: 1.27 mm
• Lead length: 1.27 mm

WIRE WRAP DIP SOCKETS

• Standard profile
• Lead spacing: 2.54 mm
• Lead width: 1.27 mm
• Lead length: 1.27 mm

741C SOCKETS

BOLDER TAIL DIP SOCKETS

• Single leads
• Lead profile
• Mount depth: 90.50 mm
• Lead spacing: 2.54 mm
• Lead width: 1.27 mm
• Lead length: 1.27 mm

WIRE WRAP DIP SOCKETS

• Standard profile
• Lead spacing: 2.54 mm
• Lead width: 1.27 mm
• Lead length: 1.27 mm

WIRE WRAP DIP SOCKETS

• Standard profile
• Lead spacing: 2.54 mm
• Lead width: 1.27 mm
• Lead length: 1.27 mm

741C SOCKETS

BOLDER TAIL DIP SOCKETS

• Single leads
• Lead profile
• Mount depth: 90.50 mm
• Lead spacing: 2.54 mm
• Lead width: 1.27 mm
• Lead length: 1.27 mm

WIRE WRAP DIP SOCKETS

• Standard profile
• Lead spacing: 2.54 mm
• Lead width: 1.27 mm
• Lead length: 1.27 mm

WIRE WRAP DIP SOCKETS

• Standard profile
• Lead spacing: 2.54 mm
• Lead width: 1.27 mm
• Lead length: 1.27 mm

741C SOCKETS

BOLDER TAIL DIP SOCKETS

• Single leads
• Lead profile
• Mount depth: 90.50 mm
• Lead spacing: 2.54 mm
• Lead width: 1.27 mm
• Lead length: 1.27 mm

WIRE WRAP DIP SOCKETS

• Standard profile
• Lead spacing: 2.54 mm
• Lead width: 1.27 mm
• Lead length: 1.27 mm

WIRE WRAP DIP SOCKETS

• Standard profile
• Lead spacing: 2.54 mm
• Lead width: 1.27 mm
• Lead length: 1.27 mm

741C SOCKETS

BOLDER TAIL DIP SOCKETS

• Single leads
• Lead profile
• Mount depth: 90.50 mm
• Lead spacing: 2.54 mm
• Lead width: 1.27 mm
• Lead length: 1.27 mm

WIRE WRAP DIP SOCKETS

• Standard profile
• Lead spacing: 2.54 mm
• Lead width: 1.27 mm
• Lead length: 1.27 mm

WIRE WRAP DIP SOCKETS

• Standard profile
• Lead spacing: 2.54 mm
• Lead width: 1.27 mm
• Lead length: 1.27 mm

741C SOCKETS

BOLDER TAIL DIP SOCKETS

• Single leads
• Lead profile
• Mount depth: 90.50 mm
• Lead spacing: 2.54 mm
• Lead width: 1.27 mm
• Lead length: 1.27 mm

WIRE WRAP DIP SOCKETS

• Standard profile
• Lead spacing: 2.54 mm
• Lead width: 1.27 mm
• Lead length: 1.27 mm

WIRE WRAP DIP SOCKETS

• Standard profile
• Lead spacing: 2.54 mm
• Lead width: 1.27 mm
• Lead length: 1.27 mm

741C SOCKETS

BOLDER TAIL DIP SOCKETS

• Single leads
• Lead profile
• Mount depth: 90.50 mm
• Lead spacing: 2.54 mm
• Lead width: 1.27 mm
• Lead length: 1.27 mm

WIRE WRAP DIP SOCKETS

• Standard profile
• Lead spacing: 2.54 mm
• Lead width: 1.27 mm
• Lead length: 1.27 mm

WIRE WRAP DIP SOCKETS

• Standard profile
• Lead spacing: 2.54 mm
• Lead width: 1.27 mm
• Lead length: 1.27 mm

SERVICE CHARGES VOLUME DISCOUNT
 0.00-0.99 Add \$2.00
 1.00-4.99 Add \$3.00
 5.00-9.99 Add \$4.00
 10.00-24.99 Add \$5.00
 25.00-49.99 Add \$6.00
 50.00-99.99 Add \$7.00
 100.00-249.99 Add \$8.00
 250.00-499.99 Add \$9.00
 500.00-999.99 Add \$10.00
 1000.00 & up No Charge

VOLUME DISCOUNT
 0.00-99.99 10%
 100.00-499.99 15%
 500.00-999.99 20%
 1000.00-2499.99 25%
 2500.00-4999.99 30%
 5000.00-9999.99 35%
 10000.00 & up 40%

CIRCLE 82 ON FREE INFORMATION CARD

ADVERTISING INDEX

RADIO-ELECTRONICS does not assume any responsibility for errors that may appear in the Index below.

Free Information Number	Page				
81	A.I.S. Satellite	27	57	Digital Research Computers	85
108	AAC Sales	81	124	Digitron	85
76	AP Products	30	120	Electronic Parts Outlet	102
—	Advance Electronics	33	188	Elephant Electronics	26
107	All Electronics	84	111,178	Emco	27
72	Amazing Devices	87	100	Etronix	14,73
77	B&K Precision	22	121	Firestik II	12
177,98	Beckman Industrial	13,20	—	Fiske Manufacturing	7
176	Beckman Industrial	28	—	Fordham Radio	11,CV4
85	Blue Star Industries	27	—	Grantham College of Engineering	38
109	C & S Sales	25	62	HW Sams	31
—	CIE	16	86	Hameg	29
89	Cameo Enterprises	27	196	Heath	21
—	Command Productions	81	179	Hi-Shure	79
79,194	Communications Electronics	3,23	65	Intek Electronics	27
190	Cook's Institute	24	59	J & W	90
—	Coop's Satellite Digest	76	113,180	JDR Instruments	9
125	Copper Electronics	12	181,182	JDR Microdevices	94,95
127	Deco Industries	26,27	183	JDR Microdevices	96,97
186	Del-Phone Industries	26	114	JDR Microdevices	98
95	Dick Smith Electronics	88,89	104	Jameco	92,93
82	Digi-Key	101	87	Jan Crystals	81
				MCM Electronics	100
				Mark V. Electronics	99
				NRI	34
				Norsal Communications	26
				O.K. Industries	73
				Omnitron	14
				Pacific Cable	83
				Pacific One	27
				Pomona Electronics	CV3
				Print Products International	78
				Probemaster	15
				Prof. Diving School of N.Y.	10
				Projector Recorder Belt	12
				Proress	CD14
				RAG Electronics	5
				Radio Shack	91
				Saratoga Electronics	86
				Satellite TV Week Magazine	77
				Tektronix	CV2
				Test Probes	27
				W.S. Jenks	10
				Wavetek	24
				Wm B. Allen	78
				YMK Enterprises	28

IBM CLONE COMPONENTS

\$345.95

IBM, PC/XT COMPATIBLE

COMPLETELY
ASSEMBLED

- COMPATIBLE MOTHERBOARD with O/K Drums (Can Take 640K)
- 135 Watt Power Supply
- 5150 Style Keyboard
- XT Type Flip-Top Case



ABOVE SUPPLIED WITH ONE 1/2 HT. D.S.D.D. DISC DRIVE **\$445.95**

V-20 — 3.5MHz NEC Speed up IBM by 30%	914.95
V-20 — 8.5MHz NEC	519.95
V-30 — Replaces 8088 in your system	124.95

Basic Rom for IBM Clone Mother Board 1 3.33

E-PROMS

2786 — 450ns	90	2786 — 450ns	2.20
2718 — 450ns	1.18	2784 — 250ns	2.80
2718 — 350ns	1.59	27128 — 280ns	3.95
27327A — 450ns	1.18	27256 — 250ns	7.90
27320A — 250ns	2.20		

RAMS

16K — Dynamic — 200ns	32	18K — Static — 200ns	1.25
16K — Dynamic — 150ns	45	18K — Static — 300ns	95
64K — Dynamic — 200ns	1.15	64K — Dynamic — 150ns	1.25
256K — Dynamic — 150ns	3.35	211K — Static — Static	55

ELECTRONIC PARTS OUTLET

2515 N. Scottsdale Road
Scottsdale, AZ 85257
(602) 941-9357
(602) 941-9377 (602) 941-9328, 9
(SEND FOR OUR FREE CATALOG)

MIN. ORDER \$20.00

MISCELLANEOUS IC SPECIALS

741602	95	AM2901	95	MC6809P	88
WD1908	75	AM2910	95	Z80S10	88
26S1P2	75	D3232	75	COM8017	88
SCN2681	75	14MM4018	15	Z80B1C	1.95
S17651P2	88	14S4016	85	Z80BPH	2.25
7652	85	S78530	85	Z80BS10	3.95

MM87580	95	S18522	89
D2817	95	H88147	53
MC6803P	90	CR19007	90
14S9827	90	TM59837	90
CR19217	90	Z8001APS	4.95
AMP977	90	Ca79008	88

T1 SWITCHING POWER SUPPLY

Compact, well-regulated switching power supply designed to power three 1/2 height computer expansions.

100W	25.00	1.00
200W	40.00	2.00
1.00	4.00	1.00
1.00	7.00	1.00

\$1.25 ..
SIZE 4.5" x 4.5" x 1.5" high

Please call for current prices. Prices subject to change. Please specify region to avoid price confusion. Order to supply one terminal and the VENDOR'S name. Shipping and insurance extra.

• NEW 3 RETAIL LOCATIONS AND MORE TO COME •

T199/4A KEYBOARDS

Upgrade your Terminal Station



\$2.95

Gernsback Publications, Inc.
500-B Bi-County Blvd.
Farmingdale, NY 11735
(516) 293-3000
President: Larry Steckler
Vice President: Cathy Steckler

For Advertising ONLY 516-293-3000
Larry Steckler
publisher
Arline Fishman
advertising director
Shelli Weinman
advertising associate
Lisa Strassman
credit manager
Christina Estrada
advertising assistant

SALES OFFICES

EAST/SOUTHEAST
Stanley Levitan
Eastern Sales Manager
Radio-Electronics
259-23 57th Avenue
Little Neck, NY 11362
718-428-6037, 516-293-3000

MIDWEST/Texas/Arkansas/Okla.
Ralph Bergen
Midwest Sales Manager
Radio-Electronics
540 Frontage Road—Suite 339
Northfield, IL 60093
312-446-1444

PACIFIC COAST/ Mountain States
Marvin Green
Pacific Sales Manager
Radio-Electronics
15335 Morrison St.—Suite 227
Sherman Oaks, CA 91403
818-986-2001

CIRCLE 124 ON FREE INFORMATION CARD

What Pomona knows about Dip Clips™ would fill a book.

For over 30 years Pomona Electronics has maintained its position on the leading edge of electronic test technology. Our expanding line of Dip Clip test clips is a good example.

Every year since dual-in-line packages were introduced to the electronics industry, we have kept pace with Dip Clip models to test the ever-increasing variety of DIP's available. This year is no exception.

In our 1986 General Catalog you'll find more than 30 models of Dip Clips. We've even introduced five special new SOIC models designed to test the small outline integrated circuit packages used in surface mount technology (SMT).

Here's how to get your copy of our 1986 General Catalog: Just circle the reader service number below; call us at (714) 623-3463; write us at ITT Pomona Electronics, a division of ITT Corporation, 1500 East Ninth Street, P.O. Box 2767, Pomona, California 91769.

Our products are available through your favorite electronics parts distributor.



ITT

Pomona Electronics

CIRCLE 101 ON FREE INFORMATION CARD



SCOPE 3 1/2 DIGIT LCD MINI-METER WITH THE MAXI-SPECS

Small enough to fit in your shirt pocket

\$29.95
ONLY

Model
DVM-630

Model CC-30 Deluxe
Zippered Carrying Case \$4.50

- 0.5% DC accuracy
- 6 Functions, 19 Ranges
 - DC Voltage, 0.1 mV to 1000 V • DC Current, 0.1 uA to 2A • Resistance, 0.1 ohm to 2 M ohm • Diode Test • Battery Test
- Measures approx. 5 x 2 3/4 x 7/8 in.
- 300 hour battery life
- Automatic zero adjust
- Low battery indication
- Test leads included



SCOPE HAND-HELD DIGITAL CAPACITANCE and MULTIMETERS

- 0.5% DC Accuracy
- Highest Quality
- Highest Performance
- Lowest Prices



Model DCM-602

\$69.95

3 1/2 Digit Capacitance Meter

8 ranges with full scale values to 2000 uF
FEATURES • Broad test range - 1 pF to 2000 uF • LSI circuit provides high reliability and durability • Lower power consumption • Crystal time base
 • Protected from charged capacitors
 • Frequency range - 800 Hz to 8 Hz

Model DVM-634

\$48.75

7 functions, 32 ranges.
 Transistor measurement included.

Model DVM-638

\$79.95

11 functions, 38 ranges.
 Includes logic level detector, audible visual continuity, capacitance and conductance measurement.

Model DVM-636

\$62.75

8 functions, 37 ranges.
 Capacitance measurement included.

3 1/2 Digital Multimeters

FEATURES • DC Voltage 100 uV - 1000 V • AC Voltage 100 uV - 750 V • AC/DC Current 200 uA - 10 Amps • Resistance 20 Megohms • Capacitance (DVM 636/638) 1 pF - 20 uF
 • Overload Protection • Auto-decimal LCD readout • Polarity indication • 300 hour battery life with 9V transistor battery • Low battery indication

ASK FOR FREE CATALOG.
 Money Orders, Checks accepted. C.O.D.'s require 25% deposit.

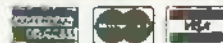

Fordham

260 Motor Parkway, Hauppauge, NY 11788

Toll Free
800-645-9518
 In NY State 800-832-1446

Service & Shipping Charge Schedule Continental U.S.A.

FOR ORDERS	ADD
\$25-\$500	\$4.50
\$101-\$250	\$6.00
\$251-\$500	\$8.00
\$501-\$750	\$10.50
\$751-\$1,000	\$12.50
\$1,001-\$1,500	\$16.90
\$1,501-\$2,000	\$20.00
\$2,001 and UP	\$25.00